



Catalyst 2900 Series XL Hardware Installation Guide

April 2001

Corporate Headquarters
Cisco Systems, Inc.
170 West Tasman Drive
San Jose, CA 95134-1706
USA
<http://www.cisco.com>
Tel: 408 526-4000
800 553-NETS (6387)
Fax: 408 526-4100

Customer Order Number: DOC-786461=
Text Part Number: 78-6461-03

THE SPECIFICATIONS AND INFORMATION REGARDING THE PRODUCTS IN THIS MANUAL ARE SUBJECT TO CHANGE WITHOUT NOTICE. ALL STATEMENTS, INFORMATION, AND RECOMMENDATIONS IN THIS MANUAL ARE BELIEVED TO BE ACCURATE BUT ARE PRESENTED WITHOUT WARRANTY OF ANY KIND, EXPRESS OR IMPLIED. USERS MUST TAKE FULL RESPONSIBILITY FOR THEIR APPLICATION OF ANY PRODUCTS.

THE SOFTWARE LICENSE AND LIMITED WARRANTY FOR THE ACCOMPANYING PRODUCT ARE SET FORTH IN THE INFORMATION PACKET THAT SHIPPED WITH THE PRODUCT AND ARE INCORPORATED HEREIN BY THIS REFERENCE. IF YOU ARE UNABLE TO LOCATE THE SOFTWARE LICENSE OR LIMITED WARRANTY, CONTACT YOUR CISCO REPRESENTATIVE FOR A COPY.

The following information is for FCC compliance of Class A devices: This equipment has been tested and found to comply with the limits for a Class A digital device, pursuant to part 15 of the FCC rules. These limits are designed to provide reasonable protection against harmful interference when the equipment is operated in a commercial environment. This equipment generates, uses, and can radiate radio-frequency energy and, if not installed and used in accordance with the instruction manual, may cause harmful interference to radio communications. Operation of this equipment in a residential area is likely to cause harmful interference, in which case users will be required to correct the interference at their own expense.

The following information is for FCC compliance of Class B devices: The equipment described in this manual generates and may radiate radio-frequency energy. If it is not installed in accordance with Cisco's installation instructions, it may cause interference with radio and television reception. This equipment has been tested and found to comply with the limits for a Class B digital device in accordance with the specifications in part 15 of the FCC rules. These specifications are designed to provide reasonable protection against such interference in a residential installation. However, there is no guarantee that interference will not occur in a particular installation.

Modifying the equipment without Cisco's written authorization may result in the equipment no longer complying with FCC requirements for Class A or Class B digital devices. In that event, your right to use the equipment may be limited by FCC regulations, and you may be required to correct any interference to radio or television communications at your own expense.

You can determine whether your equipment is causing interference by turning it off. If the interference stops, it was probably caused by the Cisco equipment or one of its peripheral devices. If the equipment causes interference to radio or television reception, try to correct the interference by using one or more of the following measures:

- Turn the television or radio antenna until the interference stops.
- Move the equipment to one side or the other of the television or radio.
- Move the equipment farther away from the television or radio.
- Plug the equipment into an outlet that is on a different circuit from the television or radio. (That is, make certain the equipment and the television or radio are on circuits controlled by different circuit breakers or fuses.)

Modifications to this product not authorized by Cisco Systems, Inc. could void the FCC approval and negate your authority to operate the product.

The Cisco implementation of TCP header compression is an adaptation of a program developed by the University of California, Berkeley (UCB) as part of UCB's public domain version of the UNIX operating system. All rights reserved. Copyright © 1981, Regents of the University of California.

NOTWITHSTANDING ANY OTHER WARRANTY HEREIN, ALL DOCUMENT FILES AND SOFTWARE OF THESE SUPPLIERS ARE PROVIDED "AS IS" WITH ALL FAULTS. CISCO AND THE ABOVE-NAMED SUPPLIERS DISCLAIM ALL WARRANTIES, EXPRESSED OR IMPLIED, INCLUDING, WITHOUT LIMITATION, THOSE OF MERCHANTABILITY, FITNESS FOR A PARTICULAR PURPOSE AND NONINFRINGEMENT OR ARISING FROM A COURSE OF DEALING, USAGE, OR TRADE PRACTICE.

IN NO EVENT SHALL CISCO OR ITS SUPPLIERS BE LIABLE FOR ANY INDIRECT, SPECIAL, CONSEQUENTIAL, OR INCIDENTAL DAMAGES, INCLUDING, WITHOUT LIMITATION, LOST PROFITS OR LOSS OR DAMAGE TO DATA ARISING OUT OF THE USE OR INABILITY TO USE THIS MANUAL, EVEN IF CISCO OR ITS SUPPLIERS HAVE BEEN ADVISED OF THE POSSIBILITY OF SUCH DAMAGES.

AccessPath, AtmDirector, Browse with Me, CCDA, CCDE, CCDP, CCIE, CCNA, CCNP, CCSI, CD-PAC, *CiscoLink*, the Cisco NetWorks logo, the Cisco *Powered* Network logo, Cisco Systems Networking Academy, the Cisco Systems Networking Academy logo, Fast Step, Follow Me Browsing, FormShare, FrameShare, GigaStack, IGX, Internet Quotient, IP/VC, iQ Breakthrough, iQ Expertise, iQ FastTrack, the iQ Logo, iQ Net Readiness Scorecard, MGX, the Networkers logo, *Packet*, PIX, RateMUX, ScriptBuilder, ScriptShare, SlideCast, SMARTnet, TransPath, Unity, Voice LAN, Wavelength Router, and WebViewer are trademarks of Cisco Systems, Inc.; Changing the Way We Work, Live, Play, and Learn, Discover All That's Possible, and Empowering the Internet Generation, are service marks of Cisco Systems, Inc.; and Aironet, ASIST, BPX, Catalyst, Cisco, the Cisco Certified Internetwork Expert logo, Cisco IOS, the Cisco IOS logo, Cisco Systems, Cisco Systems Capital, the Cisco Systems logo,

Enterprise/Solver, EtherChannel, EtherSwitch, FastHub, FastSwitch, IOS, IP/TV, LightStream, MICA, Network Registrar, Post-Routing, Pre-Routing, Registrar, StrataView Plus, Stratm, SwitchProbe, TeleRouter, and VCO are registered trademarks of Cisco Systems, Inc. or its affiliates in the U.S. and certain other countries.

All other brands, names, or trademarks mentioned in this document or Web site are the property of their respective owners. The use of the word partner does not imply a partnership relationship between Cisco and any other company. (0102R)

Catalyst 2900 Series XL Hardware Installation Guide

Copyright © 2001, Cisco Systems, Inc.

All rights reserved.

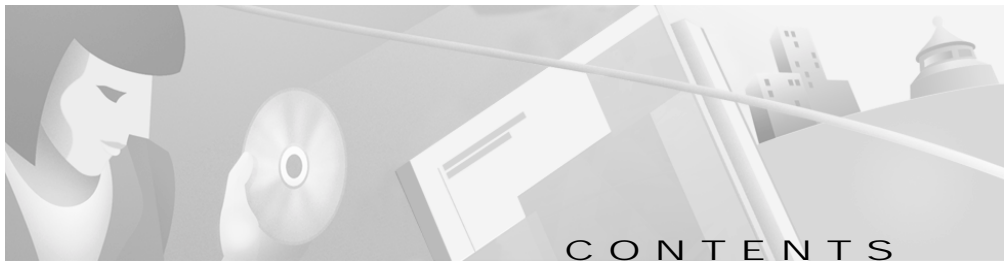

Preface xi

Audience **xi**

Purpose **xi**

Organization **xii**

Conventions **xii**

Related Publications **xvi**

Obtaining Documentation **xvii**

World Wide Web **xvii**

Cisco Documentation CD-ROM **xvii**

Ordering Documentation **xviii**

Documentation Feedback **xviii**

Obtaining Technical Assistance **xix**

Cisco.com **xix**

Technical Assistance Center **xix**

Contacting TAC by Using the Cisco TAC Website **xx**

Contacting TAC by Telephone **xx**

CHAPTER 1

Product Overview 1-1

Features **1-1**

Management Interface Options **1-4**

Front-Panel Description **1-5**

10/100 Ports **1-6**

100BASE-FX Ports **1-7**

Long-Reach Ethernet Ports **1-7**

- Expansion Slots [1-8](#)
- LEDs [1-9](#)
 - System LED [1-11](#)
 - RPS LED [1-12](#)
 - Port LEDs and Modes [1-13](#)
 - Expansion Slot LEDs [1-17](#)
- Rear-Panel Description [1-18](#)
- Power Connectors [1-19](#)
 - Internal Power Supply Connector [1-19](#)
 - Cisco RPS Connector [1-19](#)
- Console Port [1-21](#)

CHAPTER 2

Installation [2-1](#)

- Preparing for Installation [2-1](#)
 - Warnings [2-1](#)
 - EMC Regulatory Statements [2-4](#)
 - U.S.A. [2-4](#)
 - Taiwan [2-4](#)
 - Hungary [2-5](#)
 - Installation Guidelines [2-5](#)
 - Verifying Package Contents [2-6](#)
- Installing the Switch on a Table or Shelf [2-7](#)
- Installing the Switch in a Rack [2-8](#)
 - Removing Screws from the Switch [2-10](#)
 - Attaching the Brackets to a Catalyst 2912 XL, 2924C XL, 2924 XL, 2912MF XL, or 2924M XL Switch [2-11](#)
 - Attaching the Brackets to a Catalyst 2912 LRE XL or 2924 LRE XL Switch [2-17](#)
 - Mounting the Switch in a Rack [2-19](#)
 - Attaching the Optional Cable Guide [2-20](#)

- Installing the Switch on a Wall [2-22](#)
 - Attaching the Brackets to the Switch [2-22](#)
 - Mounting the Switch to a Wall [2-23](#)
- Powering On the Switch and Running POST [2-25](#)
- Connecting to a 10/100 Port [2-26](#)
- Connecting to a 100BASE-FX Port [2-28](#)
- Connecting to an LRE Port [2-30](#)
- Connecting to a Module Port [2-33](#)
- Connecting to the Console Port [2-33](#)
- Where to Go Next [2-34](#)

CHAPTER 3**Troubleshooting [3-1](#)**

- Understanding POST Results [3-2](#)
 - Correcting Module POST Failures [3-3](#)
- Diagnosing Problems [3-3](#)

APPENDIX A**Technical Specifications [A-1](#)**

APPENDIX B**Connectors and Cable Specifications [B-1](#)**

- Connector Specifications [B-1](#)
 - 10/100 Ports [B-1](#)
 - 100BASE-FX Ports [B-2](#)
 - LRE Ports [B-3](#)
 - Console Port [B-3](#)
- Cable and Adapter Specifications [B-4](#)
 - Crossover and Straight-Through Cable Pinouts [B-4](#)
 - RJ-21 Cable Pinouts [B-5](#)
 - Console Port [B-5](#)

- Identifying a Rollover Cable **B-6**
- Connecting to a PC **B-6**
- Connecting to a Terminal **B-7**

APPENDIX C

Translated Safety Warnings C-1

- Attaching the Cisco RPS (model PWR600-AC-RPS) **C-2**
- Attaching the Cisco RPS (model PWR300-AC-RPS-N1) **C-3**
- Qualified Personnel Warning **C-4**
- Installation Warning **C-5**
- Jewelry Removal Warning **C-6**
- Stacking the Chassis Warning **C-8**
- Main Disconnecting Device **C-9**
- Overtemperature Warning **C-10**
- TN Power Warning **C-13**
- Ground Connection Warning **C-14**
- Circuit Breaker (15A) Warning **C-15**
- Grounded Equipment Warning **C-17**
- Supply Circuit Warning **C-18**
- Voltage Warning **C-19**
- Power Supply Warning **C-21**
- Lightning Activity Warning **C-23**
- Product Disposal Warning **C-24**
- Class 1 Laser Product Warning **C-25**
- Laser Beam Exposure Warning **C-26**

No On/Off Switch Warning [C-27](#)

Chassis Warning—Rack-Mounting and Servicing [C-29](#)

INDEX

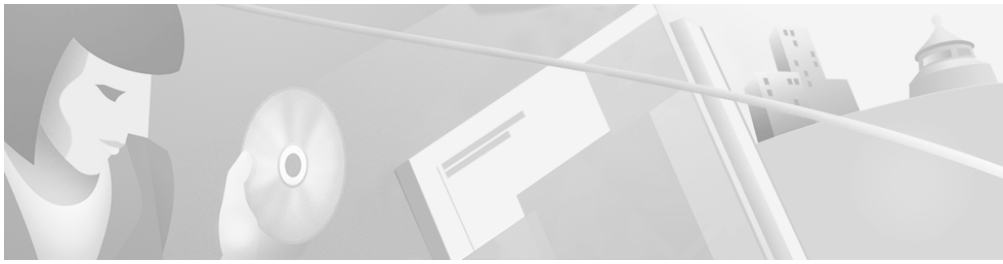

Preface

Audience

This guide is for the networking or computer technician responsible for installing and configuring a Catalyst 2900 series XL switch. We assume that you are familiar with the concepts and terminology of Ethernet and local area networking.

Purpose

The *Catalyst 2900 Series XL Hardware Installation Guide* documents the hardware features of Catalyst 2900 series XL switches. It describes the physical and performance characteristics of the switches, explains how to install a switch, and provides troubleshooting information and specifications.

Organization

This guide is organized into the following chapters:

[Chapter 1, “Product Overview,”](#) summarizes the switch features, and describes the ports, the standards they support, and the LEDs.

[Chapter 2, “Installation,”](#) provides the procedures for installing a switch in a rack, on a desk, or on a wall.

[Chapter 3, “Troubleshooting,”](#) describes how to identify and resolve some of the problems that might arise when you are installing the switch.

[Appendix A, “Technical Specifications,”](#) lists the physical and environmental specifications for the switches and the regulatory agency approvals.

[Appendix B, “Connectors and Cable Specifications,”](#) describes the connectors, cables, and adapters that can be used to connect to the switch.

[Appendix C, “Translated Safety Warnings,”](#) provides translations in various languages of the warnings in this guide.

Conventions

This guide uses the following conventions to convey instructions and information:

Command descriptions use these conventions:

- Commands and keywords are in **boldface**.
- Arguments for which you supply values are in *italic*.

Examples use these conventions:

- Terminal sessions and system displays are in `screen` font.
- Information you enter is in **boldface screen** font.
- Nonprinting characters, such as passwords or tabs, are in angle brackets (<>).

Notes, cautions, and warnings use the following conventions and symbols:



Note

Means *reader take note*. Notes contain helpful suggestions or references to materials not contained in this manual.



Caution

Means *reader be careful*. In this situation, you might do something that could result in equipment damage or loss of data.



Warning

This warning symbol means danger. You are in a situation that could cause bodily injury. Before you work on any equipment, be aware of the hazards involved with electrical circuitry and be familiar with standard practices for preventing accidents. (To see translations of the warnings that appear in this publication, refer to the [Appendix C, "Translated Safety Warnings."](#))

Waarschuwing

Dit waarschuwingssymbool betekent gevaar. U verkeert in een situatie die lichamelijke letsel kan veroorzaken. Voordat u aan enige apparatuur gaat werken, dient u zich bewust te zijn van de bij elektrische schakelingen betrokken risico's en dient u op de hoogte te zijn van standaard maatregelen om ongelukken te voorkomen. (Voor vertalingen van de waarschuwingen die in deze publicatie verschijnen, kunt u het aanhangsel C "Translated Safety Warnings" (Vertalingen van veiligheidsvoorschriften) raadplegen.)

Varoitus

Tämä varoitusmerkki merkitsee vaaraa. Olet tilanteessa, joka voi johtaa ruumiinvammaan. Ennen kuin työskentelet minkään laitteiston parissa, ota selvää sähkökytkentöihin liittyvistä vaaroista ja tavanomaisista onnettomuuksien ehkäisykeinoista. (Tässä julkaisussa esiintyvien varoitusten käännökset löydät liitteestä C "Translated Safety Warnings" (käännetyt turvallisuutta koskevat varoitukset).)

- Attention** Ce symbole d'avertissement indique un danger. Vous vous trouvez dans une situation pouvant entraîner des blessures. Avant d'accéder à cet équipement, soyez conscient des dangers posés par les circuits électriques et familiarisez-vous avec les procédures courantes de prévention des accidents. Pour obtenir les traductions des mises en garde figurant dans cette publication, veuillez consulter l'annexe intitulée C « Translated Safety Warnings » (Traduction des avis de sécurité).
- Warnung** Dieses Warnsymbol bedeutet Gefahr. Sie befinden sich in einer Situation, die zu einer Körperverletzung führen könnte. Bevor Sie mit der Arbeit an irgendeinem Gerät beginnen, seien Sie sich der mit elektrischen Stromkreisen verbundenen Gefahren und der Standardpraktiken zur Vermeidung von Unfällen bewusst. (Übersetzungen der in dieser Veröffentlichung enthaltenen Warnhinweise finden Sie im Anhang mit dem Titel C "Translated Safety Warnings" (Übersetzung der Warnhinweise).)
- Avvertenza** Questo simbolo di avvertenza indica un pericolo. Si è in una situazione che può causare infortuni. Prima di lavorare su qualsiasi apparecchiatura, occorre conoscere i pericoli relativi ai circuiti elettrici ed essere al corrente delle pratiche standard per la prevenzione di incidenti. La traduzione delle avvertenze riportate in questa pubblicazione si trova nell'appendice C, "Translated Safety Warnings" (Traduzione delle avvertenze di sicurezza).
- Advarsel** Dette varselsymbolet betyr fare. Du befinner deg i en situasjon som kan føre til personskade. Før du utfører arbeid på utstyr, må du være oppmerksom på de faremomentene som elektriske kretser innebærer, samt gjøre deg kjent med vanlig praksis når det gjelder å unngå ulykker. (Hvis du vil se oversettelser av de advarslene som finnes i denne publikasjonen, kan du se i vedlegget C "Translated Safety Warnings" [Oversatte sikkerhetsadvarsler].)

- Aviso** Este símbolo de aviso indica perigo. Encontra-se numa situação que lhe poderá causar danos físicos. Antes de começar a trabalhar com qualquer equipamento, familiarize-se com os perigos relacionados com circuitos eléctricos, e com quaisquer práticas comuns que possam prevenir possíveis acidentes. (Para ver as traduções dos avisos que constam desta publicação, consulte o apêndice C “Translated Safety Warnings” - “Traduções dos Avisos de Segurança”).
- ¡Advertencia!** Este símbolo de aviso significa peligro. Existe riesgo para su integridad física. Antes de manipular cualquier equipo, considerar los riesgos que entraña la corriente eléctrica y familiarizarse con los procedimientos estándar de prevención de accidentes. (Para ver traducciones de las advertencias que aparecen en esta publicación, consultar el apéndice titulado C “Translated Safety Warnings.”)
- Varning!** Denna varningssymbol signalerar fara. Du befinner dig i en situation som kan leda till personskada. Innan du utför arbete på någon utrustning måste du vara medveten om farorna med elkretsar och känna till vanligt förfarande för att förebygga skador. (Se förklaringar av de varningar som förekommer i denna publikation i appendix C "Translated Safety Warnings" [Översatta säkerhetsvarningar].)

Related Publications

You can order printed copies of documents with a DOC-xxxxxx= number.

The following publications provide more information about the switches:

- *Release Notes for the Catalyst 2900 Series XL and Catalyst 3500 Series XL, Cisco IOS Release 12.0(5)WC(1)*
- Catalyst 2900 XL and Catalyst 3500 XL Documentation CD



Note

This product-specific CD contains only the Catalyst 2900 XL and Catalyst 3500 XL switch documents and related hardware documents. This CD is not the same as the Cisco Documentation CD-ROM, which contains the documentation for all Cisco products and is shipped with all Cisco products.

This CD is shipped with the switch and has the following publications:

- *This Catalyst 2900 Series XL Hardware Installation Guide* (order number DOC-786461=)
- *Catalyst 2900 Series XL and Catalyst 3500 Series XL Software Configuration Guide, Cisco IOS Release 12.0(5)WC(1)* (order number DOC-786511=)
- *Catalyst 2900 Series XL and Catalyst 3500 Series XL Command Reference, Cisco IOS Release 12.0(5)WC(1)* (order number DOC-7812155=)
- *Catalyst 2900 Series XL Modules Installation Guide* (order number DOC-CAT2900-IG=)
- *Catalyst 2900 Series XL ATM Modules Installation and Configuration Guide* (order number DOC-785472=)
- *1000BASE-T Gigabit Interface Converter Installation Note* (not orderable but is available on Cisco.com)
- *Catalyst GigaStack Gigabit Interface Converter Hardware Installation Guide* (order number DOC-786460=)

- *Cisco 575 LRE CPE Hardware Installation Guide* (order number DOC-7811469=)
- *Installation Notes for the Cisco LRE 48 POTS Splitter* (order number DOC-7812250=)

Obtaining Documentation

The following sections provide sources for obtaining documentation from Cisco Systems.

World Wide Web

You can access the most current Cisco documentation on the World Wide Web at the following sites:

- <http://www.cisco.com>
- <http://www-china.cisco.com>
- <http://www-europe.cisco.com>

Cisco Documentation CD-ROM

Cisco documentation and additional literature are available in a CD-ROM package, which ships with your product. The Cisco Documentation CD-ROM is updated monthly and may be more current than printed documentation. The CD-ROM package is available as a single unit or as an annual subscription.



Note

This CD contains the documentation for all Cisco products and is shipped with all Cisco products. This CD is not the same as the Catalyst 2900 XL and Catalyst 3500 XL Documentation CD, which contains only the Catalyst 2900 XL and Catalyst 3500 XL switch documents and related hardware documents.

Ordering Documentation

Cisco documentation is available in the following ways:

- Registered Cisco Direct Customers can order Cisco Product documentation from the Networking Products Marketplace:
http://www.cisco.com/cgi-bin/order/order_root.pl
- Registered Cisco.com users can order the Documentation CD-ROM through the online Subscription Store:
<http://www.cisco.com/go/subscription>
- Nonregistered CCO users can order documentation through a local account representative by calling Cisco corporate headquarters (California, USA) at 408 526-7208 or, in North America, by calling 800 553-NETS(6387).

Documentation Feedback

If you are reading Cisco product documentation on the World Wide Web, you can send us your comments by completing the online survey. When you display the document listing for this platform, click **Give Us Your Feedback**. If you are using the product-specific CD and you are connected to the Internet, click the pencil-and-paper icon in the toolbar to display the survey. After you display the survey, select the manual that you wish to comment on. Click **Submit** to send your comments to the Cisco documentation group.

You can e-mail your comments to bug-doc@cisco.com.

To submit your comments by mail, for your convenience many documents contain a response card behind the front cover. Otherwise, you can mail your comments to the following address:

Cisco Systems, Inc.
Document Resource Connection
170 West Tasman Drive
San Jose, CA 95134-9883

We appreciate your comments.

Obtaining Technical Assistance

Cisco provides Cisco.com as a starting point for all technical assistance. Customers and partners can obtain documentation, troubleshooting tips, and sample configurations from online tools. For Cisco.com registered users, additional troubleshooting tools are available from the TAC website.

Cisco.com

Cisco.com is the foundation of a suite of interactive, networked services that provides immediate, open access to Cisco information and resources at anytime, from anywhere in the world. This highly integrated Internet application is a powerful, easy-to-use tool for doing business with Cisco.

Cisco.com provides a broad range of features and services to help customers and partners streamline business processes and improve productivity. Through Cisco.com, you can find information about Cisco and our networking solutions, services, and programs. In addition, you can resolve technical issues with online technical support, download and test software packages, and order Cisco learning materials and merchandise. Valuable online skill assessment, training, and certification programs are also available.

Customers and partners can self-register on Cisco.com to obtain additional personalized information and services. Registered users can order products, check on the status of an order, access technical support, and view benefits specific to their relationships with Cisco.

To access Cisco.com, go to the following website:

<http://www.cisco.com>

Technical Assistance Center

The Cisco TAC website is available to all customers who need technical assistance with a Cisco product or technology that is under warranty or covered by a maintenance contract.

Contacting TAC by Using the Cisco TAC Website

If you have a priority level 3 (P3) or priority level 4 (P4) problem, contact TAC by going to the TAC website:

<http://www.cisco.com/tac>

P3 and P4 level problems are defined as follows:

- P3—Your network performance is degraded. Network functionality is noticeably impaired, but most business operations continue.
- P4—You need information or assistance on Cisco product capabilities, product installation, or basic product configuration.

In each of the above cases, use the Cisco TAC website to quickly find answers to your questions.

To register for Cisco.com, go to the following website:

<http://www.cisco.com/register/>

If you cannot resolve your technical issue by using the TAC online resources, Cisco.com registered users can open a case online by using the TAC Case Open tool at the following website:

<http://www.cisco.com/tac/caseopen>

Contacting TAC by Telephone

If you have a priority level 1 (P1) or priority level 2 (P2) problem, contact TAC by telephone and immediately open a case. To obtain a directory of toll-free numbers for your country, go to the following website:

<http://www.cisco.com/warp/public/687/Directory/DirTAC.shtml>

P1 and P2 level problems are defined as follows:

- P1—Your production network is down, causing a critical impact to business operations if service is not restored quickly. No workaround is available.
- P2—Your production network is severely degraded, affecting significant aspects of your business operations. No workaround is available.



Product Overview

This chapter provides the following topics that describe the Catalyst 2900 series XL switches, hereafter referred to as *the switches*.

- Switch features, including management options
- Descriptions of the front and rear panels
- Descriptions of the LEDs

Features

The switches are stackable 10/100 Ethernet switches to which you can connect workstations, Cisco IP Phones, and other network devices such as servers, routers, and other switches. The 2900 XL LRE switches employ Long-Reach Ethernet (LRE), a very-high-data-rate digital subscriber line (VDSL)-based technology that allows an Ethernet network to reach distances up to 4921 feet (1500 meters). The switches can be deployed as backbone switches, aggregating 10/100 and Gigabit Ethernet traffic from other network devices.

The Catalyst 2900 XL switches have these features:

- Autonegotiates speed and duplex operation on all 10/100 ports
- Operates in full-duplex mode on all 100BASE-FX ports
- Checks for errors on a received packet, determines the destination port, stores the packet in shared memory, and then forwards the packet to the destination port

- On the Catalyst 2924M XL and Catalyst 2912MF XL switches, two expansion slots for 10BASE-T/100BASE-TX, 100BASE-FX, Gigabit Ethernet, and asynchronous transfer mode (ATM) modules
- On the Catalyst 2912 LRE XL and 2924 LRE XL switches, up to 24 LRE ports through one RJ-21 connector
- Supports up to 2048 MAC addresses on the Catalyst 2924 XL, 2924C XL, and 2912 XL switches
- Supports up to 8192 MAC addresses on the Catalyst 2924M XL and 2912MF XL switches

Figure 1-1 shows the switch models.

Figure 1-1 Catalyst 2900 Series XL Switches

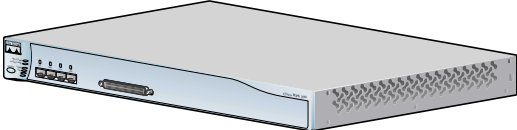
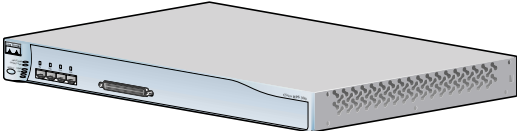
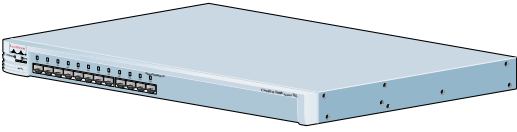
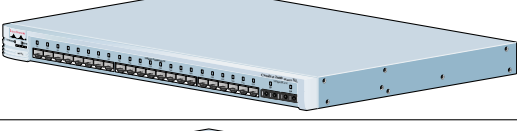
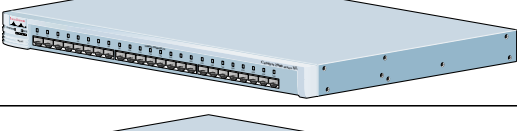
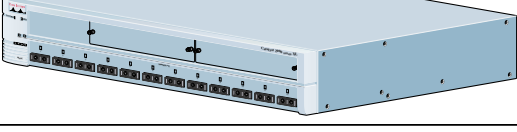
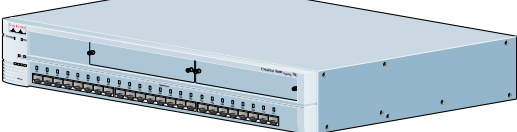
Version Number	Description	
WS-C2912-LRE-XL	4 fixed autosensing 10/100 ports 12 LRE ports	
WS-C2924-LRE-XL	4 fixed autosensing 10/100 ports 24 LRE ports	
WS-C2912-XL	12 fixed autosensing 10/100 ports	
WS-C2924C-XL	22 fixed autosensing 10/100 ports 2 100BASE-FX ports	
WS-C2924-XL	24 fixed autosensing 10/100 ports	
WS-C2912MF-XL	12 100BASE-FX ports 2 expansion slots	
WS-C2924M-XL	24 fixed autosensing 10/100 ports 2 expansion slots	

47294

Management Interface Options

The Catalyst 2900 XL and Catalyst 3500 XL switches are designed for plug-and-play operation: you only need to assign basic IP information to the switch and connect it to the other devices in your network. If you have specific network needs, you can configure and monitor the switch—on an individual basis or as part of a switch cluster—through its various management interfaces.

You can configure and monitor individual switches and switch clusters by using the following interfaces:

- **Cluster Management Suite (CMS)**—CMS is a graphical user interface that can be launched from anywhere in your network through a web browser such as Netscape Communicator or Microsoft Internet Explorer. CMS is already installed on the switch, and no additional installation is required. Using CMS, you can fully configure and monitor a standalone switch, a specific cluster member, or an entire switch cluster. You can also display network topologies to gather link information, and display switch images to modify switch- and port-level settings.
- **Command-line Interface (CLI)**—The switch CLI Cisco IOS software and is enhanced to support desktop-switching features. You can fully configure and monitor the switch and switch cluster members from the CLI. You can access the CLI either by connecting your management station directly to the switch console port or by using Telnet from a remote management station.
- **Simple network management protocol (SNMP)**—SNMP provides a means to monitor and control the switch and switch cluster members. You can manage switch configuration settings, performance, security, and collect statistics by using SNMP management applications such as CiscoWorks2000 LAN Management Suite (LMS) and HP OpenView.

You can manage the switch from an SNMP-compatible management station that is running platforms such as HP OpenView or SunNet Manager. The switch supports a comprehensive set of MIB extensions and four Remote Monitoring (RMON) groups.

For more information about CMS, the CLI, and SNMP refer to the *Catalyst 2900 Series XL and Catalyst 3500 Series XL Software Configuration Guide*.

Front-Panel Description

Depending on the model, the switch front panels can have up to 24 10/100 ports (See [Figure 1-2](#)), up to 12 100BASE-FX ports (See [Figure 1-2](#)), 2 expansion slots (see [Figure 1-2](#)), and up to 24 Long-Reach Ethernet ports (See [Figure 1-4](#)). All switches have a set of LEDs and a Mode button. This section describes these front-panel components.

Figure 1-2 Catalyst 2900 XL Front-Panel 10/100 Ports

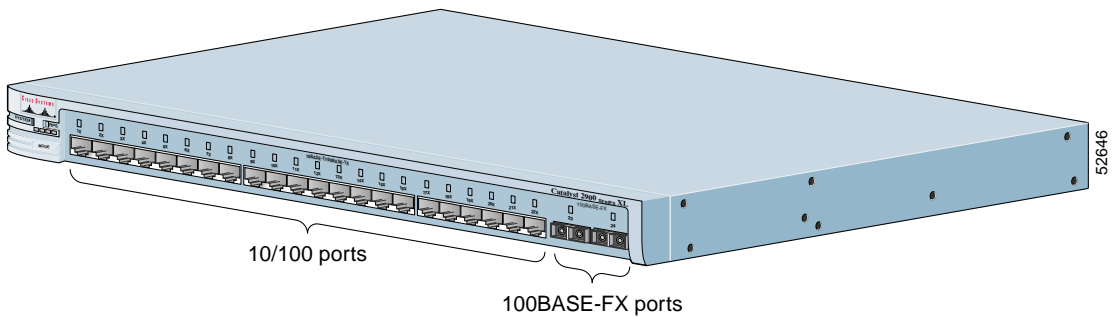

Figure 1-3 Catalyst 2900 XL 100BASE-FX ports and Expansion Slots

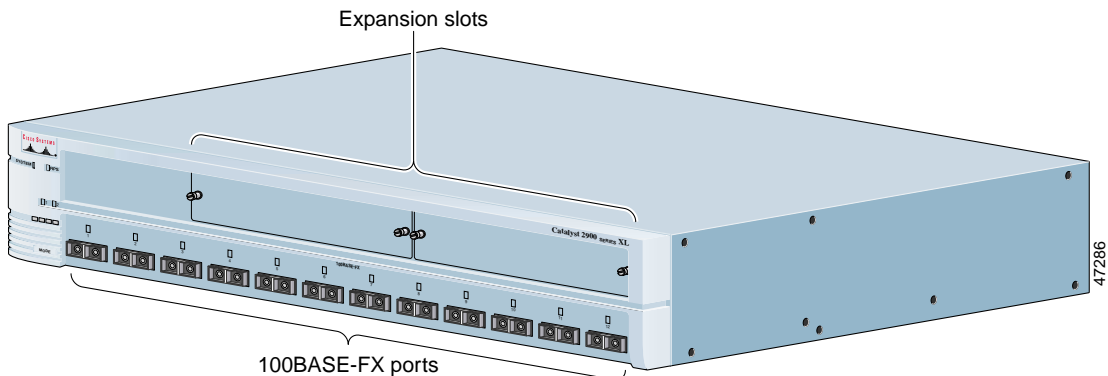
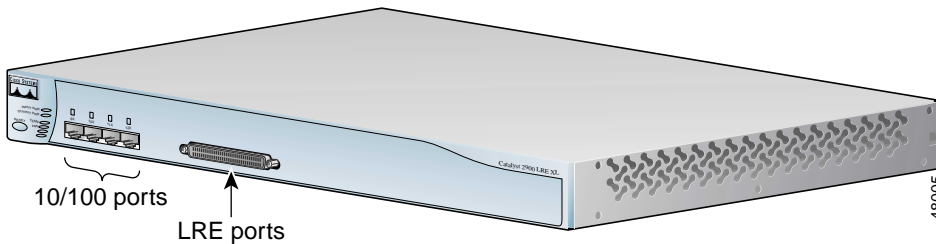

Figure 1-4 Catalyst 2900 LRE XL 10/100 and LRE Ports



10/100 Ports

The 10/100 switch ports (see [Figure 1-2](#) and [Figure 1-4](#)) can connect to any compatible network device up to 328 feet (100 meters) away:

- 10BASE-T-compatible devices, such as workstations, Cisco IP Phones, and hubs through standard RJ-45 connectors and Category 3, 4, or 5 cabling
- 100BASE-TX-compatible devices, such as high-speed workstations, Cisco IP Phones, servers, hubs, routers, and other switches through standard RJ-45 connectors and Category 5 cabling



Note

A Category 5 cable is required for 100BASE-TX traffic. A port operating at 10BASE-T can use Category 3 and 4 cables.

When connecting the switch to workstations, servers, routers, and Cisco IP Phones, be sure that the cable is a straight-through, twisted-pair cable. When connecting the switch to switches or hubs, use a crossover cable. Pinouts for the cables are described in [Appendix B, “Connectors and Cable Specifications.”](#)

The 10/100 switch ports can be explicitly set to operate in any combination of half duplex, full duplex, 10 Mbps, or 100 Mbps. These ports also can be set for speed and duplex autonegotiation, compliant with IEEE 802.3u. When set for autonegotiation, the port senses the speed and duplex settings of the attached device and advertises its own capabilities. If the connected device also supports autonegotiation, the switch port negotiates the best connection (that is, the fastest line speed that both devices support and full-duplex transmission if the attached device supports it) and configures itself accordingly.

The 10/100 ports on the Catalyst 2900 XL switches provide protocol support for Cisco IP Phones and per-port priority override. Refer to the *Catalyst 2900 Series XL and Catalyst 3500 Series XL Software Configuration Guide* for more information about these features.

Cisco IP Phones—connected to the 10/100 port—must be connected to an AC power source. Unlike the 3524-PWR XL switch, the Catalyst 2900 XL switches do not provide inline power.

For more info on the Catalyst 3524-PWR XL switch, refer to the *Catalyst 3500 Series XL Hardware Installation Guide*.

100BASE-FX Ports

The 100BASE-FX ports use 10/125- or 62.5/125-micron multimode fiber-optic cabling. The connection distances between the switch and the attached device can be as follows:

- If the switch port and the port on the attached device are configured for half-duplex operation, the connection can be up to 1352 feet (412 meters).
- If the switch port and the port on the attached device are configured for full-duplex operation, the connection can be over distances of up to 6562 feet (2 kilometers).

Long-Reach Ethernet Ports

The Long-Reach Ethernet (LRE) ports ([Figure 1-4](#)) use one RJ-21 connector to connect up to 24 Cisco 575 LRE customer premises equipment (CPE) devices through unstructured wiring, such as existing telephone lines. The link between the LRE switch port and each CPE device can reach speeds of up to 15 Mbps (full duplex) and distances of up to 4921 feet (1500 meters).

The default mode for each LRE port is speed autonegotiation, half duplex operation. For information about configuring the LRE ports, refer to the *Catalyst 2900 Series XL and Catalyst 3500 Series XL Software Configuration Guide*.

For more information about the Cisco 575 LRE CPE, refer to the *Cisco 575 LRE CPE Hardware Installation Guide*.

If telephone services, such as voice or integrated services digital network (ISDN), use the same cabling as LRE traffic, the LRE port must be connected to the patch panel through a basic telephone service, also known as *plain old telephone service* (POTS) splitter. The splitter routes LRE data (high-frequency) and voice (low-frequency) traffic from the telephone line to the switch and private branch exchange (PBX) switch or public-switched telephone network (PSTN)

If the other telephone services are connected through a private branch exchange (PBX) switch, a Cisco LRE 48 POTS Splitter can be used. The PBX routes voice traffic to private telephone networks and the public system telephone network (PSTN). For more information about the Cisco LRE 48 POTS Splitter (PS-1M-LRE-48), refer to the *Installation Notes for the Cisco LRE 48 POTS Splitter*.

If the installation does not have a PBX, a homologated POTS splitter is required to directly connect to the PSTN. For more information about homologated POTS splitters, contact your Cisco sales representative.

Note

If a connection to a phone network is not required at all, a splitter is not needed, and the switch can connect directly to the patch panel.

Expansion Slots

The expansion slots (see [Figure 1-2](#)) are for the Catalyst 2900 XL hot-swappable modules. Each module port is internally switched to other switch ports and is managed through the switch management interfaces.

[Table 1-1](#) lists the modules that the expansion slots support.

Table 1-1 Expansion Modules

Module Type	Model Number
10/100 Ethernet	WS-X2914-XL
	WS-X2914-XL-V
	WS-X2922-XL
100 BASE-FX	WS-X2922-XL-V
	WS-X2924-XL-V

Table 1-1 Expansion Modules (continued)

Module Type	Model Number
¹ Ethernet Gigabit	WS-X2931-XL
ATM	WS-X2971-XL
	WS-X2972-XL
	WS-X2951-XL
	WS-X2961-XL

1. Accommodates modules WS-G5484 =, WS-G5486 =, and WS-X3500-XL=

These modules automatically configure themselves when you insert them in expansion slots and tighten the thumb screws. A power-on self-test (POST) verifies that the module is working properly before it starts forwarding packets.

Modules WS-X2914-XL and WS-X2922-XL support 2048 MAC addresses. If you install one of these modules in a 2924M XL or Catalyst 2912MF XL switch (both supporting 8192 MAC addresses), the module fails POST. You can start the module by restarting the switch with the module installed. After the restart, the switch address capacity is reduced to 2048 MAC addresses.

See the *Catalyst 2900 Series XL Modules Installation Guide* and the *Catalyst 2900 Series XL ATM Modules Installation and Configuration Guide* for detailed information on expansion modules for Catalyst 2900 series XL switches.

LEDs

You can use the switch LEDs to monitor switch activity and its performance. [Figure 1-5](#), [Figure 1-6](#), and [Figure 1-7](#) show the location of the LEDs and the Mode button that you use to select a port mode. Changing a port mode changes the information provided by each port LED.

All of the LEDs described in this section except the utilization meter (UTL) are visible on the Cluster Management Suite (CMS) window and, if the switch is a cluster member, on the CMS Cluster Manager window. The *Catalyst 2900 Series XL and Catalyst 3500 Series XL Software Configuration Guide* describes how to use CMS to manage standalone or individual switches and how to use cluster management software to manage switch clusters].

Figure 1-5 Catalyst 2912 XL, 2924 XL, and 2924C XL LEDs

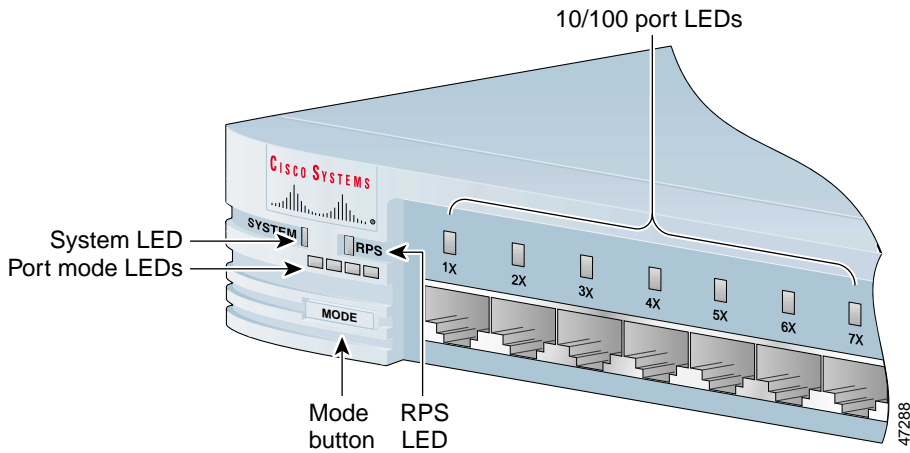

Figure 1-6 Catalyst 2912MF XL and 2924M XL LEDs

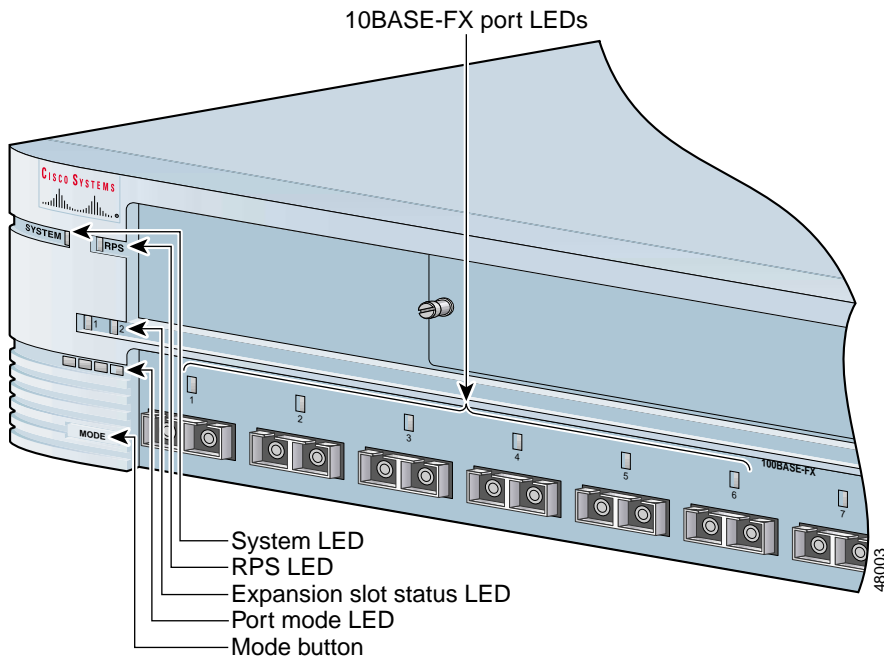
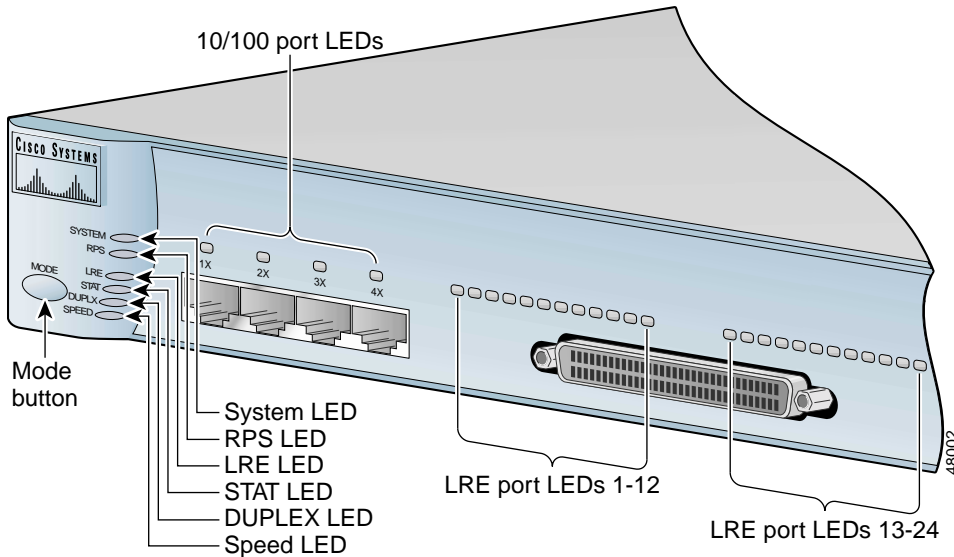

Figure 1-7 Catalyst 2912 LRE XL and 2924 LRE XL LEDs



System LED

The system LED shows whether the system is receiving power and functioning properly. [Table 1-2](#) lists the LED colors and their meanings.

Table 1-2 System LED

Color	System Status
Off	System is not powered up.
Green	System is operating normally.
Amber	System is receiving power but is not functioning properly.

For information on the System LED colors during POST, see the [“Powering On the Switch and Running POST”](#) section on page 2-25.

RPS LED

The Catalyst 2912 LRE XL, Catalyst 2924 LRE XL, and Catalyst 3524-PWR XL switches use the Cisco RPS 300 (model PWR300-AC-RPS-N1). All other Catalyst 2900 XL and Catalyst 3500 XL switches use the Cisco RPS 600 (model PWR600-AC-RPS). Refer to the appropriate switch documentation for redundant power system (RPS) descriptions specific for the switch. [Table 1-3](#) and [Table 1-4](#) list the RPS LED colors and their meanings.

Table 1-3 RPS LED on the Catalyst 2912 XL, 2924C XL, 2924 XL, 2924MF XL, and 2924M XL Switches

Color	RPS Status
Off	RPS is off or is not installed.
Green	RPS is operational.
Blinking green	<p>The RPS and the switch AC power supply are both powered up. If the switch power supply fails, the switch powers down and after 15 seconds restarts, using power from the RPS. The switch goes through its normal boot sequence when it restarts.</p> <p>Note This is not a recommended configuration. For more information see the “Cisco RPS Connector” section on page 1-19.</p>
Amber	<p>RPS is connected but not functioning.</p> <ul style="list-style-type: none"> • The RPS could be in standby mode. Pressing the Mode button on the RPS puts it in Ready mode, and the LED should turn green. • One of the power supplies in the RPS could have failed. • The fan in the RPS might have failed.

Table 1-4 RPS LED on the Catalyst 2912 LRE XL and 2924 LRE XL Switches

Color	RPS Status
Off	RPS is off or is not installed.
Solid green	RPS is connected and operational.
Blinking green	RPS is backing up another switch in the stack.

Table 1-4 RPS LED on the Catalyst 2912 LRE XL and 2924 LRE XL Switches (continued)

Color	RPS Status
Solid amber	RPS is connected but not functioning properly. <ul style="list-style-type: none"> The RPS could be in standby mode. Pressing the Standby/Active button the RPS puts it in Active mode, and the LED should turn green. One of the power supplies in the RPS could be powered down. A fan in the RPS might have failed.
Blinking amber	Internal power supply of the switch is down, and redundancy is lost. The switch is operating on the RPS.

Port LEDs and Modes

Each of the 10/100, 100BASE-FX, and LRE ports and module slots have a port LED. These port LEDs, as a group or individually, display information about the switch and about the individual ports. The port modes ([Table 1-5](#) and [Table 1-6](#)) determine the type of information displayed.

To select or change a mode, press the Mode button until the desired mode is highlighted. When you change port modes, the meaning of the port LED colors also changes. [Table 1-7](#) and [Table 1-8](#) list the port LED colors.

Table 1-5 Port Mode LEDs on the Catalyst 2912 XL, 2924C XL, 2924 XL, 2924MF XL, and 2924M XL Switches

Mode LED	Port Mode	Description
STAT	Port status	The port status. This is the default mode.
UTL	Switch utilization	The current bandwidth in use by the switch. (See Figure 1-7 .)
FDUP	Port duplex mode	The port duplex mode: full duplex or half duplex.
100	Port speed	The port operating speed: 10, 100, or 1000 Mbps.

Table 1-6 Meanings of Port Status LED Colors for Different Modes on Catalyst 2912 LRE XL and 2924 LRE XL Switches

Mode LED	Port Mode	Description
LRE	LRE link status	<p>Long-Reach Ethernet (LRE) link status of the LRE ports on the Catalyst 2912 LRE XL and Catalyst 2924 LRE XL switches.</p> <p>Default mode on these switches only.</p> <p>Note When the LRE mode is active, the 10/100 switch ports on the Catalyst 2912 LRE XL and Catalyst 2924 LRE XL continue to show Ethernet link status.</p>
STAT	Port status	<p>Ethernet link status of the 10/100, 100BASE-FX, or 1000BASE-FX switch ports or the Ethernet link status on the remote CPE.</p> <p>Default mode on all Catalyst 2900 XL and Catalyst 3500 XL switches except the Catalyst 2912 LRE XL and Catalyst 2924 LRE XL switches.</p>
DUPLX	Port duplex mode	The port duplex mode: full duplex or half duplex.
SPEED	Port speed	The port operating speed: 10 or 100 Mbps.

Table 1-7 Meanings of Port Status LED Colors for Different Modes on Catalyst 2912 XL, 2924C XL, 2924 XL, 2924MF XL, and 2924M XL Switches

Port Mode	Port LED Color	Meaning
STAT (port status)	Off	No link.
	Solid green	Link present.
	Flashing green	Activity. Port is transmitting or receiving data.
	Alternating green-amber	Link fault. Error frames can affect connectivity, and errors such as excessive collisions, CRC errors, and alignment and jabber errors are monitored for a link-fault indication.
	Solid amber	Port is not forwarding. Port was disabled by management or an address violation or was blocked by Spanning Tree Protocol (STP). Note After a port is reconfigured, the port LED can remain amber for up to 30 seconds as STP checks the switch for possible loops.
UTL (utilization)	Green	The LEDs display backplane utilization on a logarithmic scale. If all port LEDs are green, the switch is using 50 percent or more of its total bandwidth capacity. If the right-most LED is amber, the switch is using less than 50 percent of its total bandwidth. If the LED to the left of the right-most LED is amber, the switch is using less than 25 percent of its total capacity, and so on. See Figure 1-7 for details.
FDUP (port duplex)	Off	Port is operating in half duplex.
	Green	Port is operating in full duplex.
100 (port speed)	Off	Port is operating at 10 Mbps.
	Green	Port is operating at 100 Mbps.

Table 1-8 Meanings of Port Status LED Colors for Different Modes on Catalyst 2912 LRE XL and 2924 LRE XL Switches

Port Mode	Port LED Color	Meaning
LRE	Off	No LRE link present on the LRE port.
	Green	LRE link present on the LRE port. Port LED turns green within 10 seconds after the LRE port detects a connection to a Cisco 575 LRE CPE.
	Amber	LRE port and WAN CPE port unable to establish the rate defined by the assigned profile. The switch has detected a CPE, but has not established an LRE link at the configured profile. Note The LED can be amber for a short period of time while an LRE link is being established. However, if the LED remains amber, there is a problem with the link between the switch and the CPE.
STAT (port status)	Off	No link.
	Solid green	Link is present between LRE port and a CPE WAN port and also between the CPE Ethernet port and the remote Ethernet device.
	Flashing green	Activity. Port is transmitting or receiving data.
	Alternating green-amber	Link fault. Error frames can affect connectivity, and errors such as excessive collisions, CRC errors, and alignment and jabber errors are monitored for a link-fault indication.
	Solid amber	Port is not forwarding. Port was disabled by management or an address violation or was blocked by Spanning Tree Protocol (STP). Note After a port is reconfigured, the port LED can remain amber for up to 30 seconds as STP checks the switch for possible loops.
DUPLX	Off	Port is operating in half duplex.
	Green	Port is operating in full duplex.
SPEED	Off	Port is operating at 10 Mbps.
	Green	Port is operating at 100 Mbps.

Figure 1-7 shows bandwidth utilization percentages displayed by the right-most LEDs.

Figure 1-8 Bandwidth Utilization

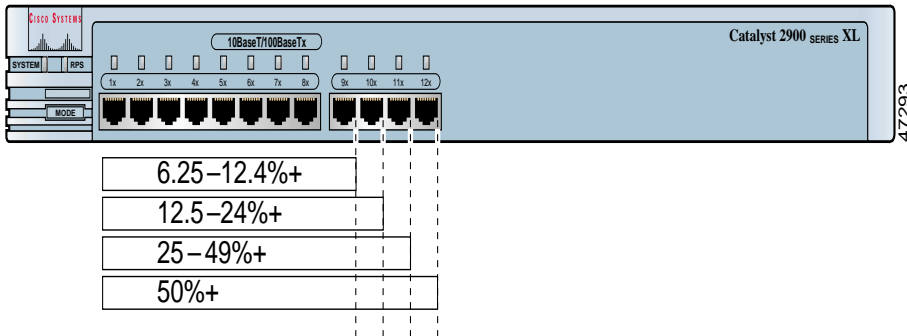

Expansion Slot LEDs

Expansion slot LEDs (shown in [Figure 1-6](#)) show the status of installed modules. The LEDs are numbered 1 (left slot) and 2 (right slot). [Table 1-9](#) lists LED colors and their meanings.

Table 1-9 Expansion Slot LEDs

Color	Expansion Slot Status
Off	No module is installed.
Green	Module is operating normally.
Amber	Module failed POST and should be replaced.

Rear-Panel Description

The switch rear panels have an AC power connector, an RPS connector, and an RJ-45 console port (see [Figure 1-10](#), [Figure 1-10](#), and [Figure 1-11](#)), which are described in this section.

Figure 1-9 Catalyst 2912 XL, 2924 XL, and 2924C XL Rear Panel

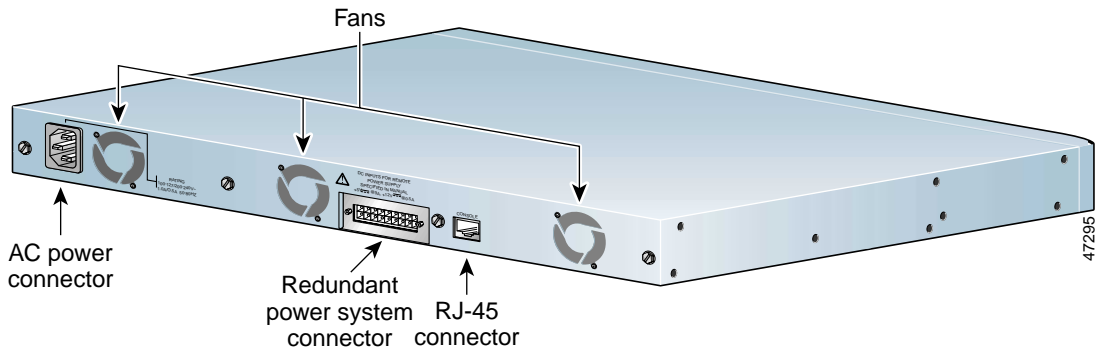

Figure 1-10 Catalyst 2924M XL and Catalyst 2912MF XL Rear Panel

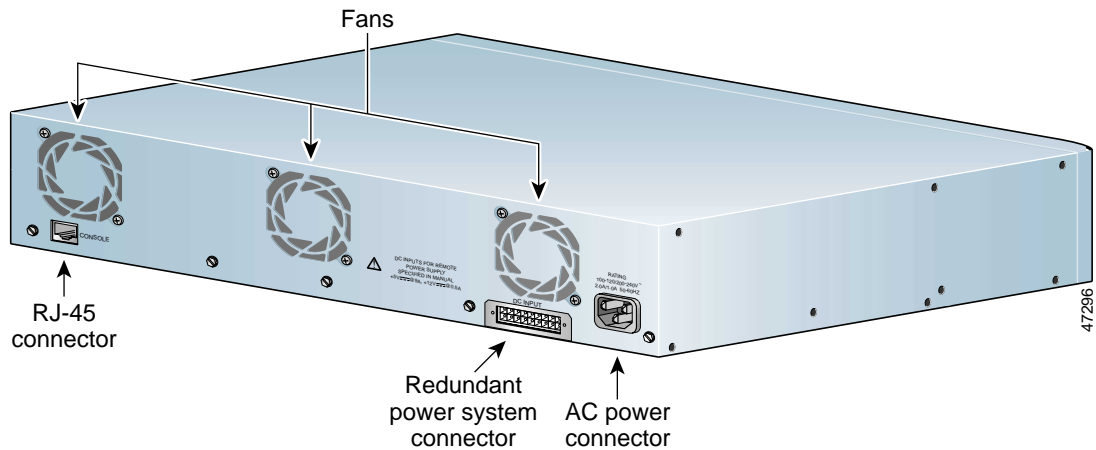
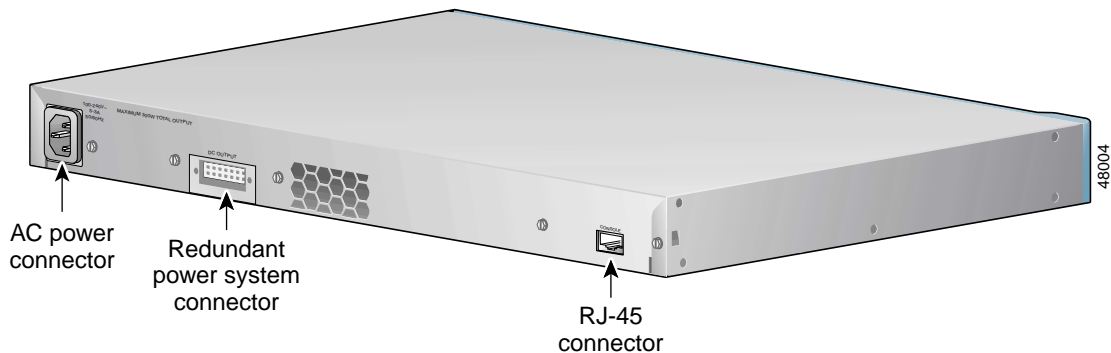

Figure 1-11 Catalyst 2912 LRE XL and 2924 LRE XL Rear Panel

Power Connectors

You can provide power to the switch either through the internal power supply or through the Cisco RPS.

Internal Power Supply Connector

The internal power supply is an autoranging unit that supports input voltages between 100 and 240 VAC. If you plan to use the internal power supply, use the supplied AC power cord to connect the AC power connector to an AC power outlet.

Cisco RPS Connector

Specific Cisco RPS models support specific Catalyst 2900 XL switches:

- Cisco RPS 600 (model PWR600-AC-RPS)—supports the Catalyst 2912 XL, 2924C XL, 2924 XL, 2924MF XL, and 2924M XL switches
- Cisco RPS 300 (model PWR300-AC-RPS-N1)—supports the Catalyst 2912 LRE XL and 2924 LRE XL switches

RPS Connector on the Catalyst 2912 XL, 2924C XL, 2924 XL, 2924MF XL, and 2924M XL Switches

The Cisco RPS 600 (model PWR600-AC-RPS) provides a quasi-redundant power source for four external devices that use up to 150W DC each. Use a one-to-one cable (one connector at each cable end) to connect four external devices to the four DC output power modules. The power source is quasi-redundant because there are two AC input power modules for the Cisco RPS and one DC output power module for each external device. The AC input to the Cisco RPS is fully redundant, but the DC output to the external devices is not.



Warning

Attach only the Cisco RPS (model PWR600-AC-RPS) to the RPS 600 receptacle.



Note

Do not connect the switch power cord to an AC outlet if the switch is also connected to a powered-on RPS. The switches do not support the fully-redundant configuration described in the RPS documentation. The redundant-with-reboot configuration is not recommended.

For more information on the Cisco RPS 600, refer to the *Cisco Redundant Power System Hardware Installation Guide*.

RPS Connector on the Catalyst 2912 LRE and 2924 LRE XL Switches

The RPS is a 300W redundant power system that can support six external network devices and provides power to one failed device at a time. It automatically senses when the power supply of a connected device fails and provides the necessary power to the failed device to prevent loss of network traffic. When the device internal power supply has been brought up or replaced, the RPS automatically stops powering the device.



Warning

Attach only the Cisco RPS (model PWR300-AC-RPS-N1) to the RPS 300 receptacle.

**Note**

The RPS can only power one switch at a time. If more than one switch fails at the same time, any subsequent switch is not supported by the RPS until the first switch failure is resolved.

For more information on the Cisco RPS 300, refer to the *Cisco Redundant Power System 300 Hardware Installation Guide*.

Console Port

You can connect a switch to a PC through the switch console port and by using the supplied rollover cable and DB-9 adapter. You need to provide a RJ-45-to-DB-25 female DTE adapter to connect the switch console port to a terminal. You can order a kit (part number ACS-DSBUASYN=) containing that adapter from Cisco. For console port and adapter pinout information, see the [“Connecting to the Console Port”](#) section on page 2-33.



Installation

This chapter describes how to install your Catalyst 2900 XL switch and interpret the power-on self-test (POST) that ensures proper operation. Read the topics and perform these procedures in the order that they are presented:

- Pre-installation information and guidelines
- Installation procedures
- Power-on procedures
- Connection procedures
- Where to go next



Note

See the *Catalyst 2900 Series XL Modules Installation Guide* and the *Catalyst 2900 Series XL ATM Modules Installation and Configuration Guide* for global information about the Catalyst 2900 series XL expansion modules.

Preparing for Installation

Warnings

These warnings are translated into several languages in [Appendix C, “Translated Safety Warnings.”](#)



Warning

Only trained and qualified personnel should be allowed to install or replace this equipment.



Warning

Read the installation instructions before you connect the system to its power source.



Warning

Before working on equipment that is connected to power lines, remove jewelry (including rings, necklaces, and watches). Metal objects will heat up when connected to power and ground and can cause serious burns or weld the metal object to the terminals.



Warning

Do not stack the chassis on any other equipment. If the chassis falls, it can cause severe bodily injury and equipment damage.



Warning

The plug-socket combination must be accessible at all times because it serves as the main disconnecting device.



Warning

To prevent the switch from overheating, do not operate it in an area that exceeds the maximum recommended ambient temperature of 113°F (45°C). To prevent airflow restriction, allow at least 3 inches (7.6 cm) of clearance around the ventilation openings.



Warning

The device is designed to work with TN power systems.



Warning

When installing the unit, the ground connection must always be made first and disconnected last.



Warning

This product relies on the building's installation for short-circuit (overcurrent) protection. Ensure that a fuse or circuit breaker no larger than 120 VAC, 15A U.S. (240 VAC, 10A international) is used on the phase conductors (all current-carrying conductors).



Warning

This equipment is intended to be grounded. Ensure that the host is connected to earth ground during normal use.



Warning

Care must be given to connecting units to the supply circuit so that wiring is not overloaded.



Warning

A voltage mismatch can cause equipment damage and may pose a fire hazard. If the voltage indicated on the label is different from the power outlet voltage, *do not connect the chassis to that receptacle*.



Warning

Do not touch the power supply when the power cord is connected. For systems with a power switch, line voltages are present within the power supply even when the power switch is off and the power cord is connected. For systems without a power switch, line voltages are present within the power supply when the power cord is connected.



Warning

Do not work on the system or connect or disconnect cables during periods of lightning activity.



Warning

Ultimate disposal of this product should be handled according to all national laws and regulations.

**Warning**

Invisible laser radiation may be emitted from the aperture ports of the 100BASE-FX single-mode supervisor engine module. Avoid exposure and do not stare into open apertures.

**Warning**

Avoid exposure to the laser beam.

**Warning**

Attach only the Cisco RPS (model PWR600-AC-RPS) to the RPS receptacle.

**Warning**

Attach only the Cisco RPS (model PWR300-AC-RPS-N1) to the RPS receptacle.

EMC Regulatory Statements

U.S.A.

U.S. regulatory information for this product is in the front matter of this manual.

Taiwan

警告使用者：
這是甲類的資訊產品，在居住的環境中使用時，可能會造成射頻干擾，在這種情況下，使用者會被要求採取某些適當的對策。

15456

Hungary

This equipment is a class A product and should be used and installed properly according to the Hungarian EMC Class A requirements (MSZEN55022). Class A equipment is designed for typical commercial establishments for which special conditions of installation and protection distance are used.

Figyelmeztetés a felhasználói kézikönyv számára:

Ez a berendezés "A" osztályú termék, felhasználására és üzembe helyezésére a magyar EMC "A" osztályú követelményeknek (MSZ EN 55022) megfelelően kerülhet sor, illetve ezen "A" osztályú berendezések csak megfelelő kereskedelmi forrásból származhatnak, amelyek biztosítják a megfelelő speciális üzembe helyezési körülményeket és biztonságos üzemelési távolságok alkalmazását.

Installation Guidelines

The switch can be installed on a table or shelf, in a rack, or on a wall.

Before installing the switch, first verify that the switch is operational by powering it on and running POST. Follow the procedures in the ["Powering On the Switch and Running POST"](#) section on page 2-25.



Caution

There are no serviceable parts inside the unit. Removing screws, cover, or otherwise dismantling the unit voids the warranty.



Warning

Unplug the power cord before you work on a system that does not have an on/off switch.

When determining where to place the switch, be sure to observe these guidelines:

- For 10/100 ports, cable lengths from the switch to connected devices are up to 328 feet (100 meters).
- For 100BASE-FX ports, cable lengths from the switch to connected devices are up to 1351 feet (412 meters) for half-duplex connections and less than 6561 feet (2 kilometers) for full-duplex connections.

- For LRE ports, cable lengths from the switch to the connected Ethernet device are up to 4921 feet (1500 meters).
- Cabling is away from sources of electrical noise, such as radios, power lines, and fluorescent lighting fixtures.
- For specifications of the expansion modules, refer to the modules documentation in the “[Related Publications](#)” section on page xvi.
- Clearance to front and rear panels meet these conditions:
 - Front-panel indicators can be easily read.
 - Access to ports is sufficient for unrestricted cabling.
 - Rear-panel power connector is within reach of an AC power receptacle.
- Operating environment is within the ranges listed in [Appendix A, “Technical Specifications.”](#)
- Airflow around the switch and through the vents is unrestricted.
- Temperature around the unit does not exceed 113°F (45°C).

**Note**

If the switch is installed in a closed or multitrack assembly, the temperature around it might be greater than normal room temperature.

Verifying Package Contents

When you unpack the switch, be sure that the package contains the items in the following list. If any items are missing, notify your authorized Cisco sales representative:

- The switch
- Catalyst 2900 XL and Catalyst 3500 XL Documentation CD
- *Release Notes for the Catalyst 2900 Series XL and Catalyst 3500 Series XL Cisco IOS Release 12.0(5)WC(1)*
- The Cisco Documentation CD-ROM package
- AC power cord

- Mounting kit containing these items:
 - Four rubber feet for mounting the switch on a table, shelf, or desk
 - Two mounting brackets
 - Four number-12 Phillips machine screws for attaching the brackets to a rack
 - Four number-8 Phillips flat-head screws for attaching the brackets to the switch (19-inch rack mount)
 - Four number-8 Phillips truss-head screws for attaching the brackets to the switch (24-inch rack mount)
 - One cable guide and one (two for modular switches) black Phillips machine screw for attaching the cable guide to one of the mounting brackets

**Note**

The cable guide is not applicable for the Catalyst 2912 LRE XL and 2924 LRE XL switches.

- One RJ-45-to-RJ-45 rollover cable
- One RJ-45-to-DB-9 adapter
- Cisco Information Packet, containing warranty, safety, and support information

Installing the Switch on a Table or Shelf

Follow these steps to install the switch on a table or shelf:

-
- Step 1** Locate the adhesive strip with the rubber feet in the mounting-kit envelope. Attach the four rubber feet to the recessed areas on the bottom of the unit.
 - Step 2** Place the switch on the table or shelf near an AC power source.
 - Step 3** After the switch is mounted on the table or shelf, power the switch as described in [“Powering On the Switch and Running POST”](#) section on page 2-25.
-

Installing the Switch in a Rack



Warning

To prevent bodily injury when mounting or servicing this unit in a rack, you must take special precautions to ensure that the system remains stable. The following guidelines are provided to ensure your safety:

- This unit should be mounted at the bottom of the rack if it is the only unit in the rack.
- When mounting this unit in a partially filled rack, load the rack from the bottom to the top with the heaviest component at the bottom of the rack.
- If the rack is provided with stabilizing devices, install the stabilizers before mounting or servicing the unit in the rack.

The supplied rack-mounting brackets can be attached to a 19-, 23-, or 24-inch rack. [Figure 2-1](#) shows which mounting holes to use.



Note

[Figure 2-1](#) shows brackets for two-rack-unit modular switches. Rack-mount points are similar on brackets for one-rack-unit switches.

Figure 2-1 *Mounting Bracket Points for Catalyst 2912 XL, 2924C XL, 2924 XL, 2912MF XL, or 2924M XL Switches*

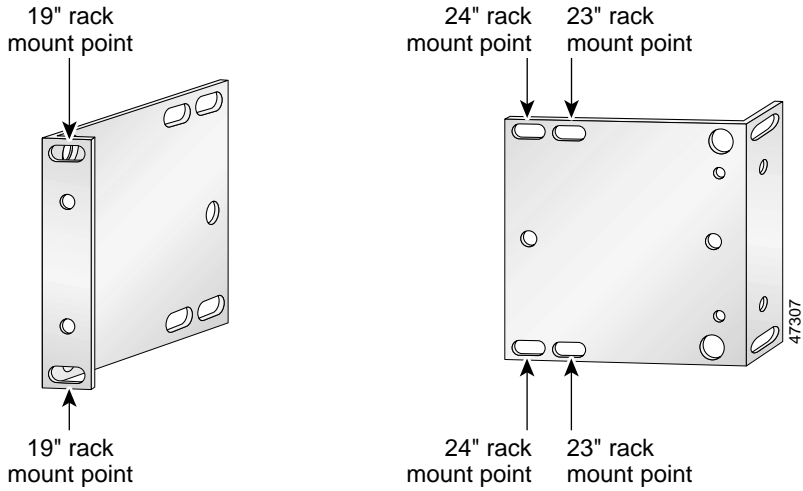
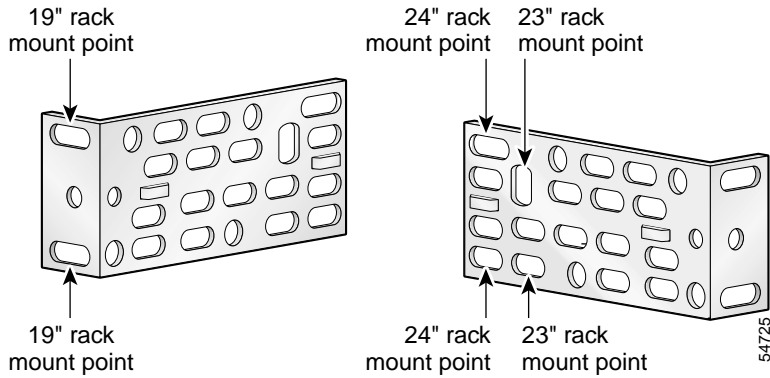

Figure 2-2 *Mounting Brackets Points for Catalyst 2912 LRE XL and 2924 LRE XL Switches*



To install the switch in a 19-, 23- or 24-inch standard rack, follow the instructions described in these procedures:

- “Removing Screws from the Switch” section on page 2-10
- “Attaching the Brackets to a Catalyst 2912 XL, 2924C XL, 2924 XL, 2912MF XL, or 2924M XL Switch” section on page 2-11
- “Attaching the Brackets to a Catalyst 2912 LRE XL or 2924 LRE XL Switch” section on page 2-17
- “Mounting the Switch in a Rack” section on page 2-19
- “Attaching the Optional Cable Guide” section on page 2-20

Removing Screws from the Switch

If you plan to install the switch in a rack, you must first remove screws in the switch chassis so that mounting brackets can be attached. [Figure 2-3](#) shows how to remove the chassis screws in a fixed-port and a modular port switch.

Figure 2-3 Removing Screws from the Switch

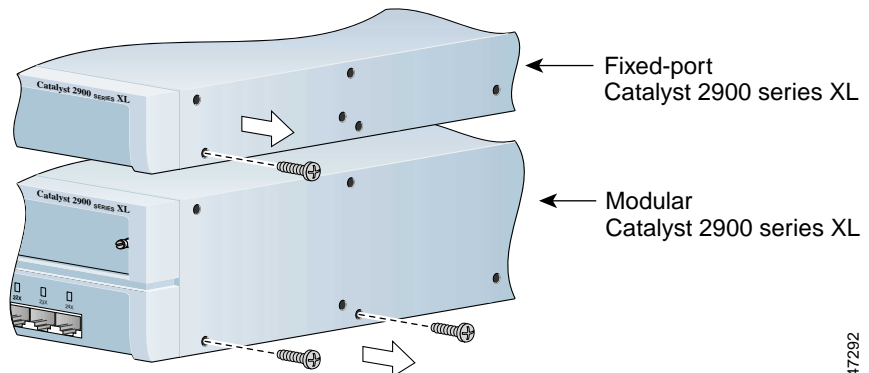

47292

Attaching the Brackets to a Catalyst 2912 XL, 2924C XL, 2924 XL, 2912MF XL, or 2924M XL Switch

Follow these steps to attach the brackets to a Catalyst 2912 XL, 2924C XL, 2924 XL, 2912MF XL, or 2924M XL switch:

The bracket orientation and screws that you use depend on whether you are attaching the brackets for a 19-, 23-, or 24-inch rack. Use two of the supplied screws to attach each bracket, according to rack size:

- For a 19-inch rack, use the supplied Phillips flat-head screws to attach the long side of the bracket to the switch.
- For a 23- or 24-inch rack, use the supplied Phillips truss-head screws to attach the short side of the bracket to the switch.

[Figure 2-3](#), [Figure 2-5](#), [Figure 2-6](#), [Figure 2-7](#), and [Figure 2-8](#) show how to attach a bracket to one side of the switch. Follow the same steps to attach the second bracket to the opposite side of the switch.

■ Installing the Switch in a Rack

Figure 2-4 Attaching Brackets on Catalyst 2912 XL, 2924C XL, 2924 XL Fixed-Port Switches (Front-Panel Forward)

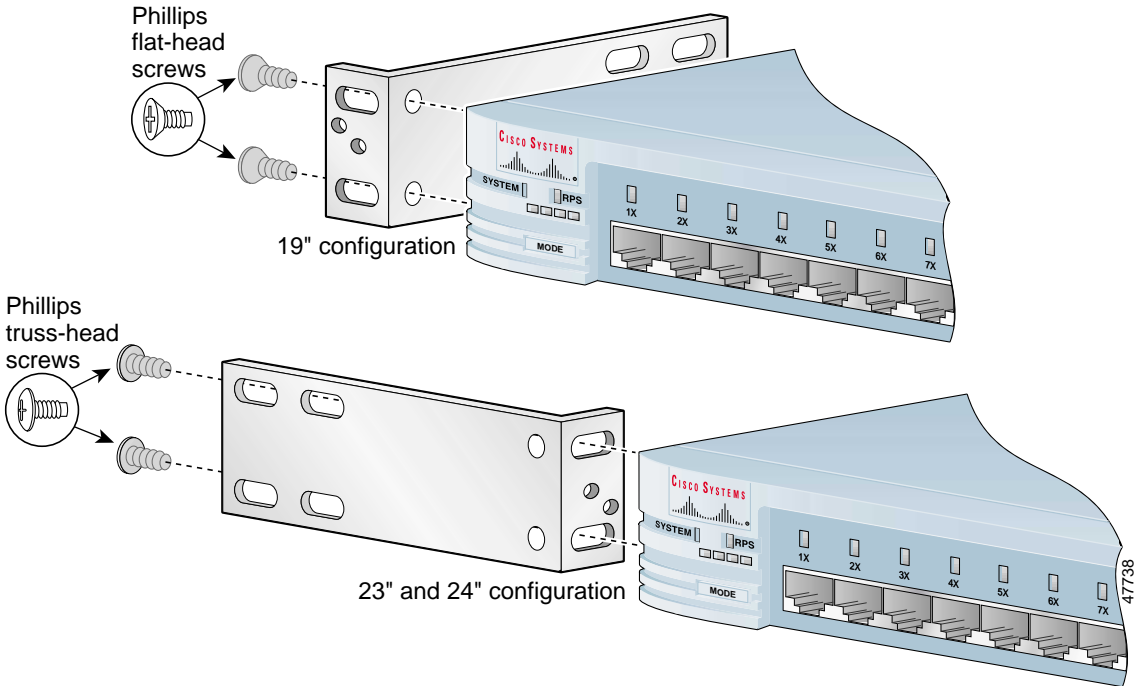

Figure 2-5 Attaching Brackets on Catalyst 2912MF XL and 2924M XL Modular Switches (Front-Panel Forward)

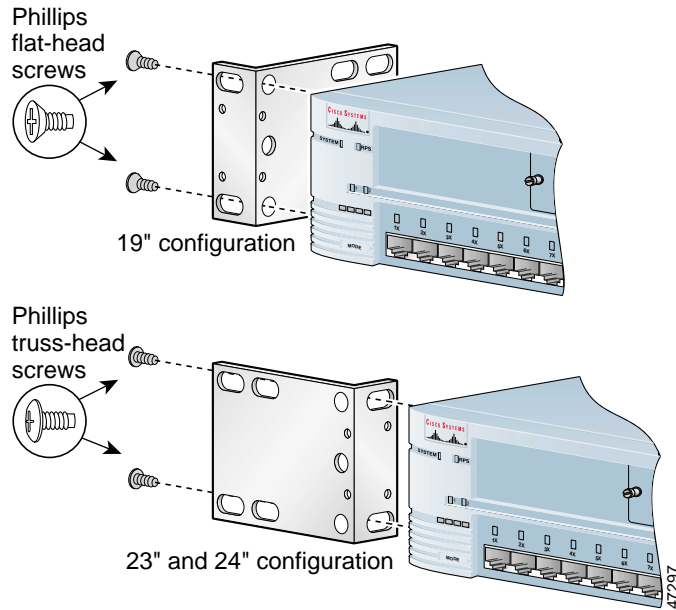

Figure 2-6 Attaching Brackets on Catalyst 2912 XL, 2924C XL, 2924 XL Fixed-Port Switches (Rear-Panel Forward)

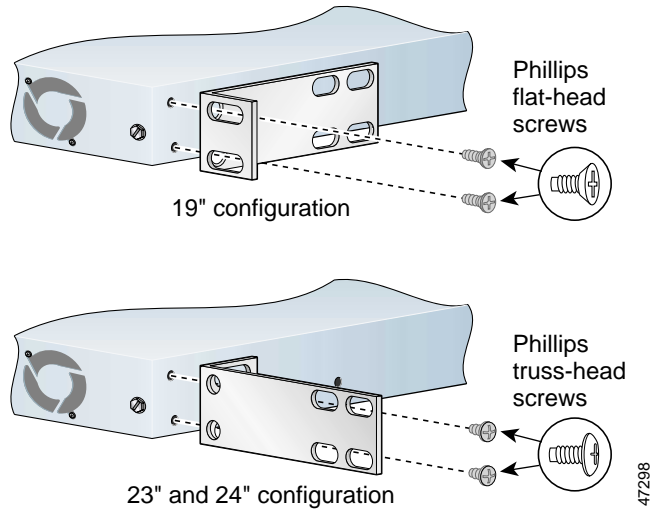

Figure 2-7 Attaching Brackets on Catalyst 2912MF XL and 2924M XL Modular Switches (Rear-Panel Forward)

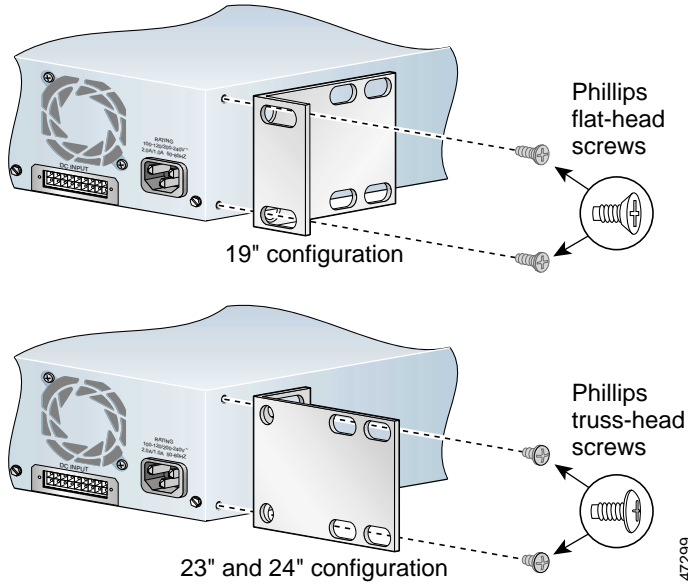
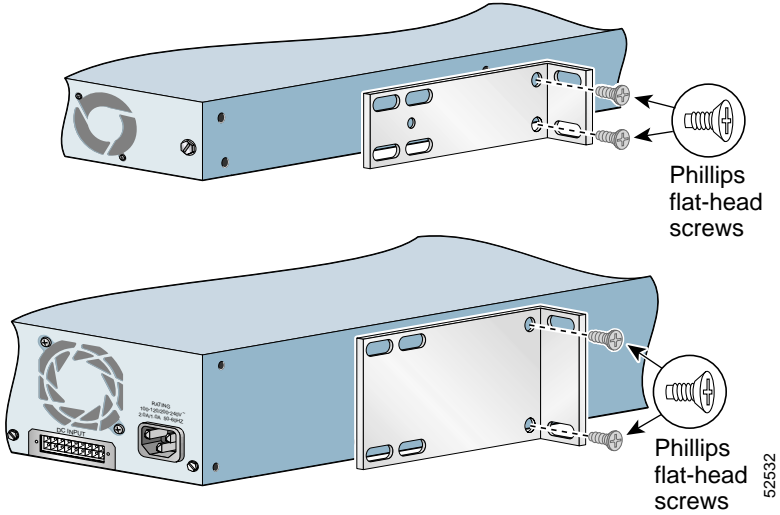

Figure 2-8 Attaching Brackets for Telco Racks



Note

Catalyst 2912 LRE XL and 2924 LRE XL switches cannot be mounted in telco racks.

Attaching the Brackets to a Catalyst 2912 LRE XL or 2924 LRE XL Switch

Follow these steps to attach the brackets to a Catalyst 2912 LRE XL or 2924 LRE XL switch:

The bracket orientation and screws that you use depend on whether you are attaching the brackets for a 19-, 23-, or 24-inch rack. Use two of the supplied screws to attach each bracket, according to rack size:

- For a 19-inch rack, use the supplied Phillips flat-head screws to attach the long side of the bracket to the switch.
- For a 23- or 24-inch rack, use the supplied Phillips truss-head screws to attach the short side of the bracket to the switch.

[Figure 2-3](#), [Figure 2-5](#), [Figure 2-6](#), [Figure 2-7](#), and [Figure 2-8](#) show how to attach a bracket to one side of the switch. Follow the same steps to attach the second bracket to the opposite side of the switch.

Figure 2-9 Attaching Brackets on Catalyst 2912 LRE XL and 2924 LRE XL Switches (Front-Panel Forward)

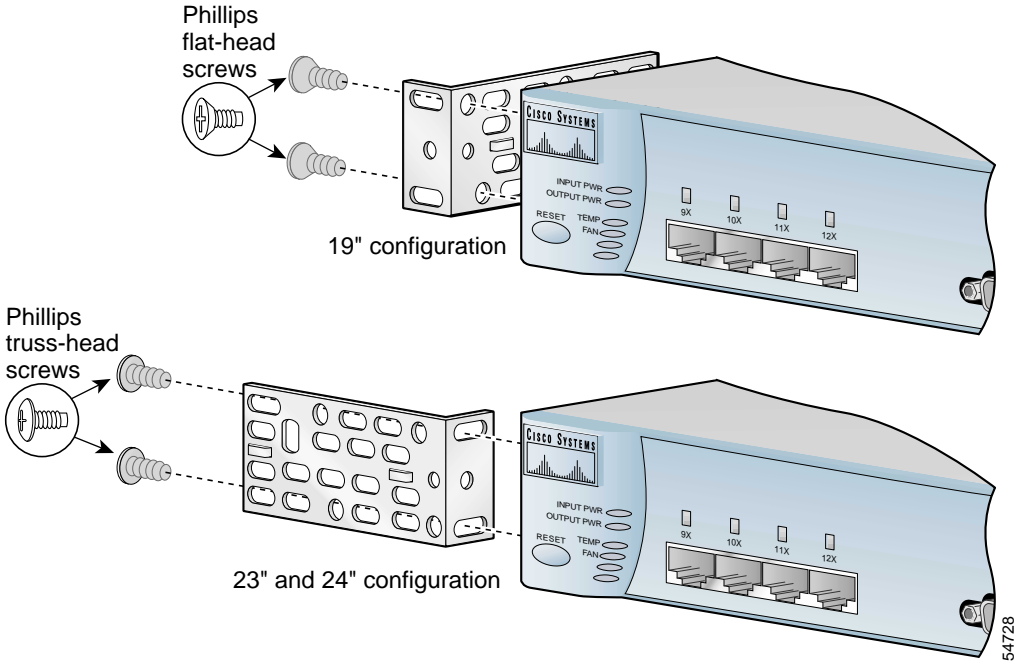
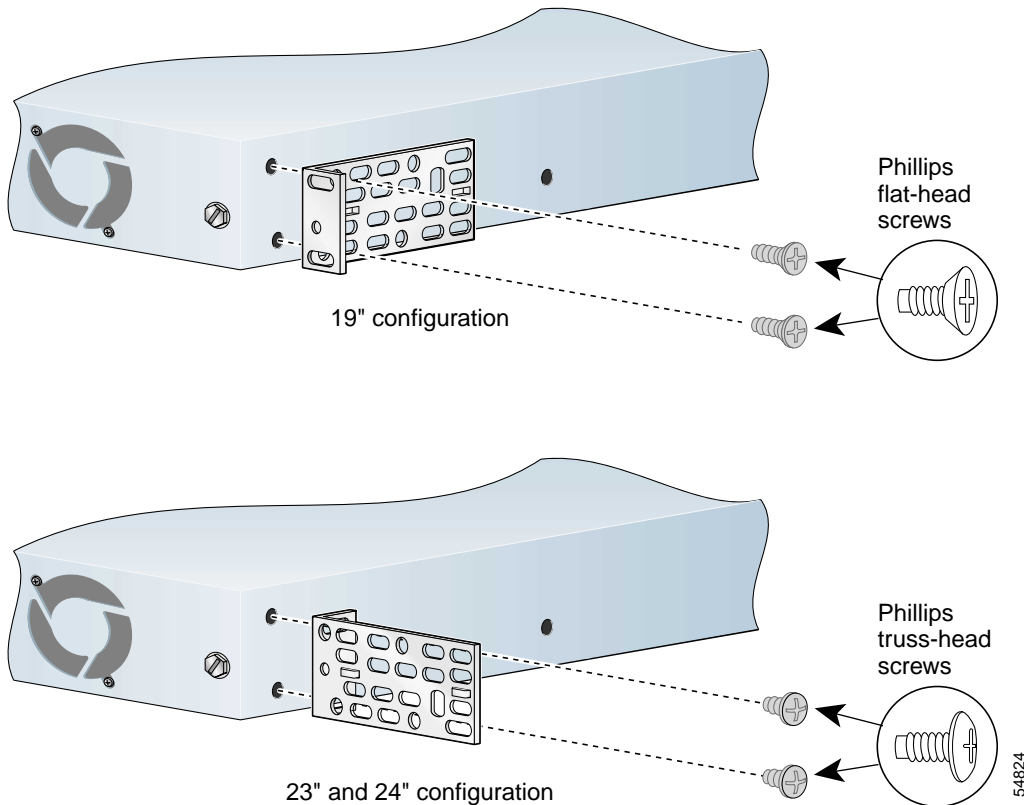

Figure 2-10 Attaching Brackets on Catalyst 2912 LRE XL and 2924 LRE XL Switches (Rear-Panel Forward)



Mounting the Switch in a Rack

After the brackets are attached to the switch, use the four supplied number-12 Phillips machine screws to securely attach the brackets to the rack, as shown in [Figure 2-11](#).

Figure 2-11 Mounting the Switch in a Rack

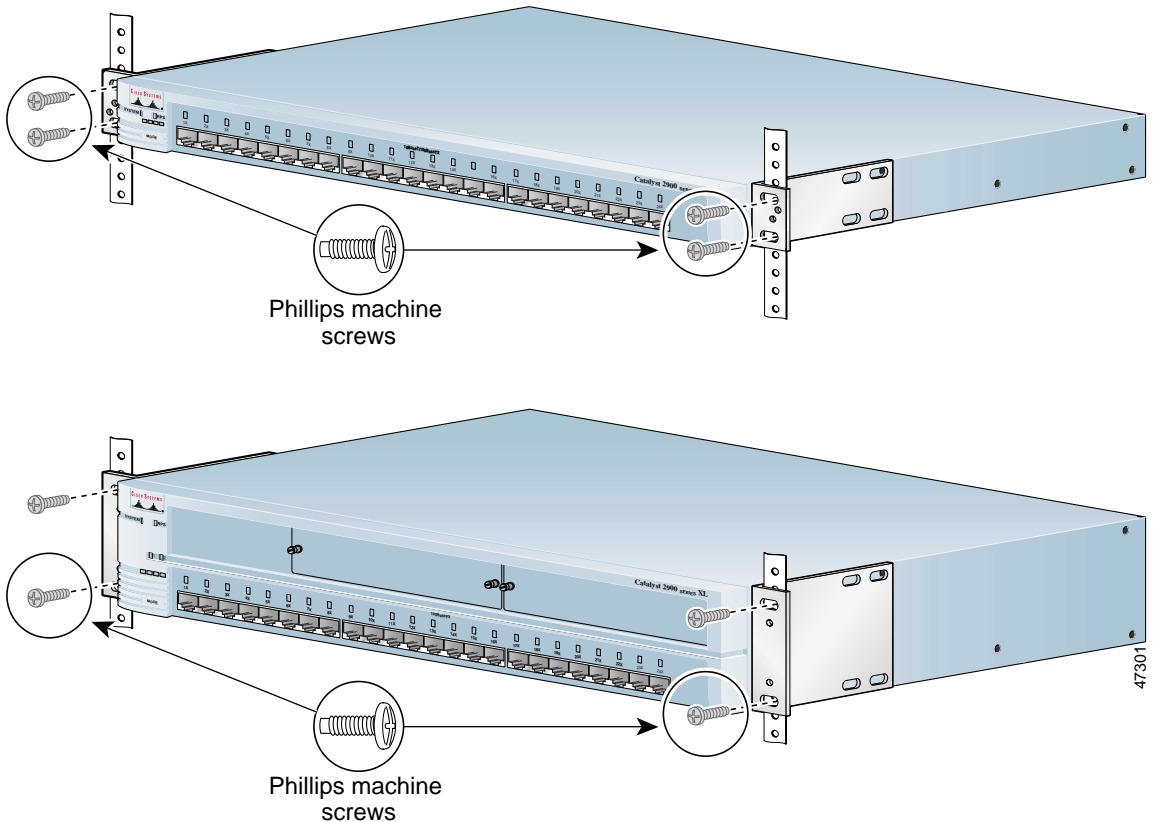

After the switch is mounted in the rack, power the switch as described in [“Powering On the Switch and Running POST”](#) section on page 2-25.

Attaching the Optional Cable Guide

We recommend attaching the cable guide to prevent the cables from obscuring the front panel of the switch and the other devices installed in the rack. If the switch is in a 19-, 23-, or 24-inch rack, use the supplied black screw as shown in [Figure 2-12](#) to attach the cable guide to the left or right bracket. The cable guide for the modular switches requires two screws.



Note The cable guide is not applicable for the Catalyst 2912 LRE XL and 2924 LRE XL switches.

Figure 2-12 Attaching the Cable Guide

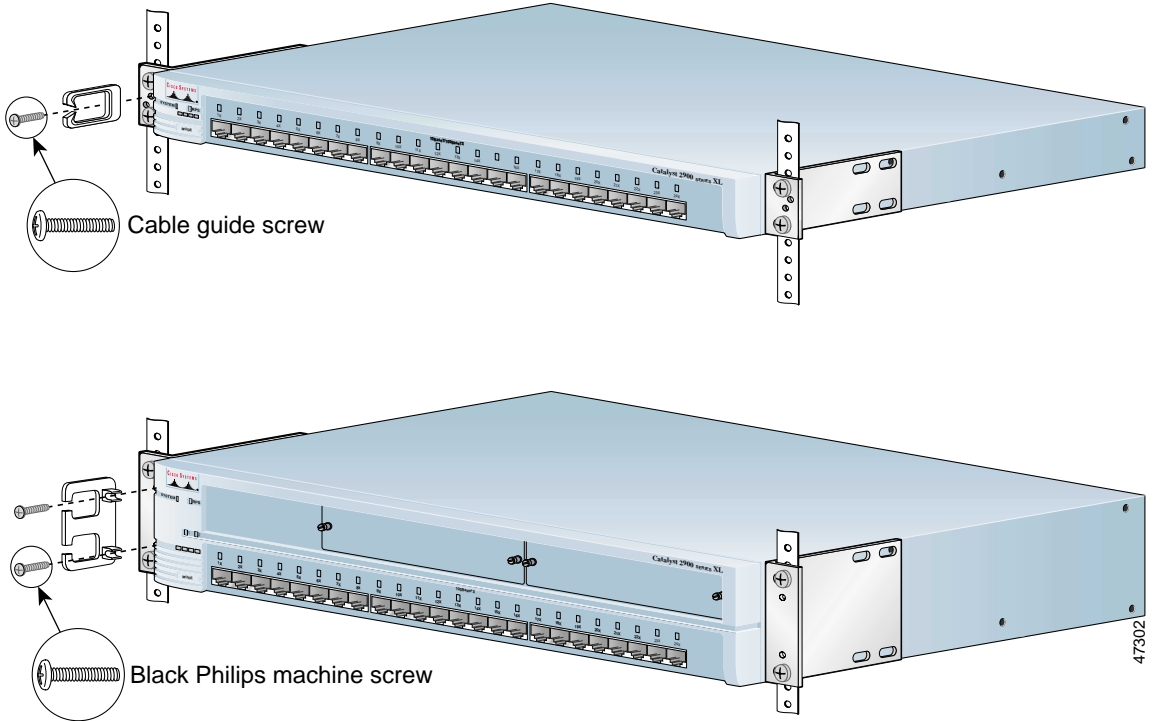

Installing the Switch on a Wall

To attach the switch to a wall, follow the procedures in this section:

- Attaching the brackets to the switch
- Attaching the switch to a wall

**Note**

To mount a Catalyst 2912 LRE XL or 2924 LRE XL switch on a wall, you need to obtain two special wall-mount brackets (Cisco part number *wallmount-1ru=*). To order these brackets, contact your Cisco sales representative.

Attaching the Brackets to the Switch

The bracket orientation and the screws you use depend on whether you are attaching the brackets for parallel or vertical wall-mounting. Use two of the supplied screws to attach each bracket, according to the following guidelines:

- For parallel wall-mounting, use the supplied Phillips truss-head screws to attach the short side of the bracket to the switch.
- For vertical wall-mounting, use the supplied Phillips flat-head screws to attach the long side of the bracket to the switch.

**Note**

The Catalyst 2912 LRE XL and 2924 LRE XL switches cannot be mounted vertically on a wall.

[Figure 2-13](#) and [Figure 2-13](#) show how to attach the brackets to one side of the switch. Follow the same steps to attach the second bracket to the opposite side of the switch.

Figure 2-13 Attaching Brackets for Parallel and Vertical Wall-Mounting for Fixed-Port Switches

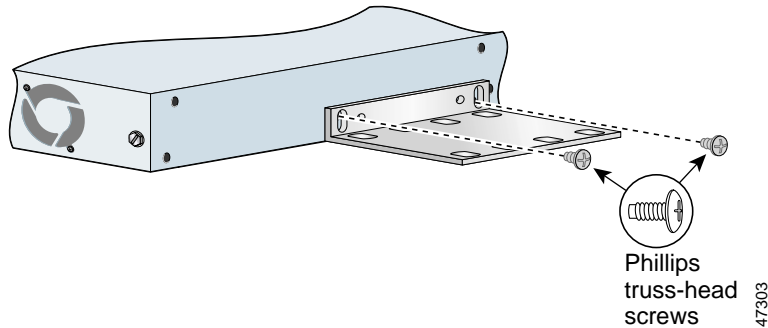
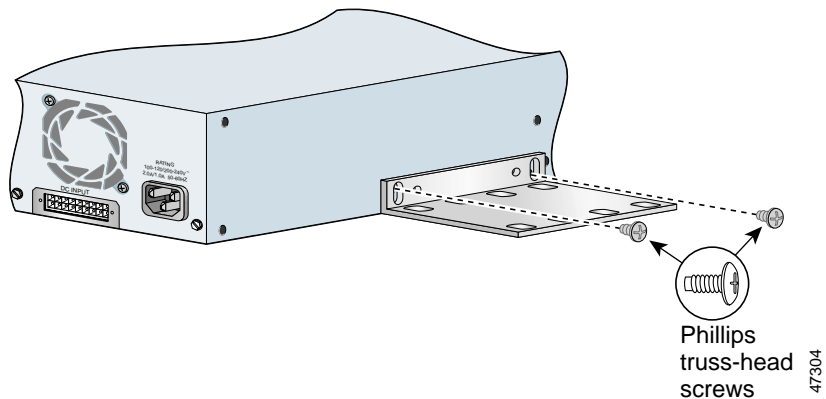

Figure 2-14 Attaching Brackets for Parallel and Vertical Wall-Mounting for Modular Switches



Mounting the Switch to a Wall

For best support of the switch and cables, make sure the switch is attached securely to a wall stud or to a firmly attached plywood mounting backboard, as shown in [Figure 2-15](#), [Figure 2-16](#), and [Figure 2-17](#).

Figure 2-15 Mounting a Fixed-Port Switch to a Wall

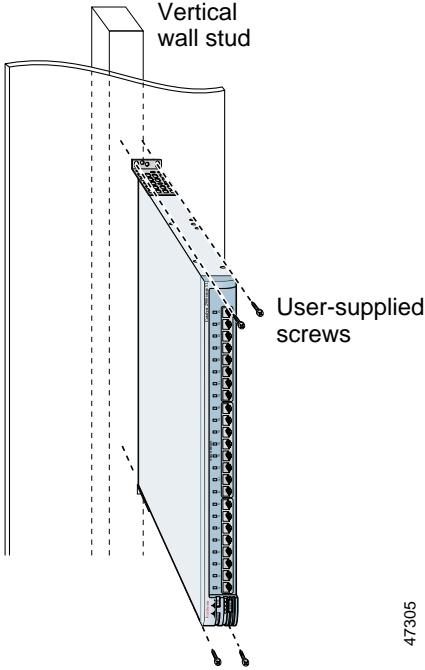

47305

Figure 2-16 Mounting a Modular Switch to a Wall

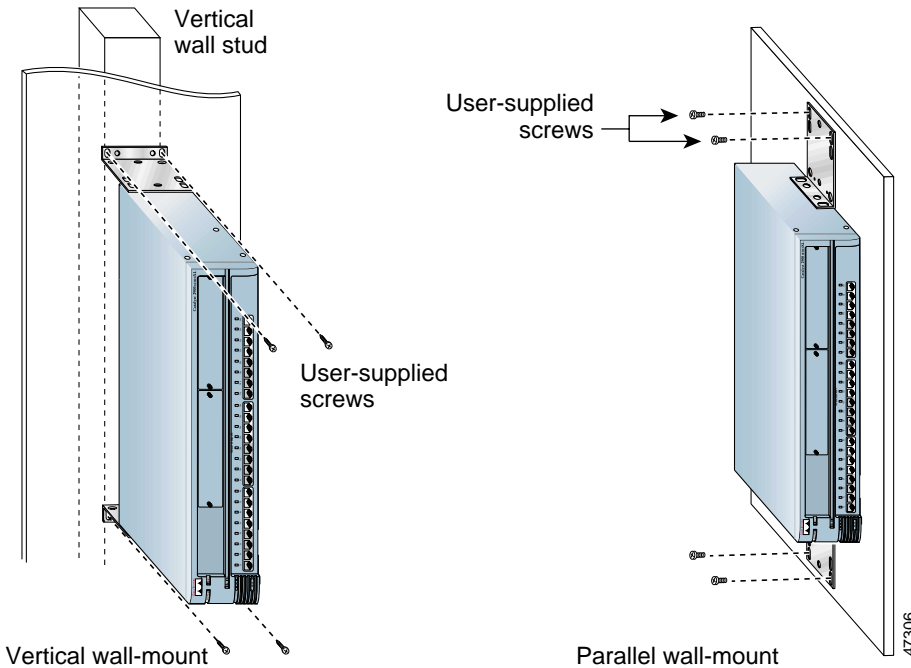

After the switch is mounted on the wall, power the switch as described in [“Powering On the Switch and Running POST”](#) section on page 2-25.

Powering On the Switch and Running POST

To power on the switch after you install it, follow these steps:

-
- Step 1 Connect one end of the AC power cord to the AC power connector on the switch.
 - Step 2 Connect the other end of the power cord to an AC power outlet.
-

As the switch powers on, it begins POST, a series of eight tests that run automatically to ensure that the switch functions properly. When the switch begins POST, the port LEDs turn amber for 2 seconds, and then they turn green.

The System LED flashes green, and the RPS LED turns off. As each test runs, the port LEDs, starting with number 1, turn off. The port LEDs for ports 2 to 8 each turn off in turn as the system completes a test.

When POST completes successfully, the port LEDs return to the status mode display, indicating that the switch is operational. If a test fails, the port LED associated with the test turns amber, and the system LED turns amber. If POST fails, refer to [Chapter 3, “Troubleshooting,”](#) to determine a course of action.

POST failures are usually fatal. Call Cisco Systems immediately if your switch does not pass POST.

Connecting to a 10/100 Port

The switch 10/100 ports configure themselves to operate at the speed of attached devices. If the attached ports do not support autonegotiation, you can explicitly set the speed and duplex parameters.

Connecting devices that do not autonegotiate or that have their speed and duplex parameters manually set can reduce performance or result in no linkage. To maximize performance, choose one of these methods for configuring the 10/100 Ethernet ports:

- Let the ports autonegotiate both speed and duplex.
- Set the port speed and duplex parameters on both ends of the connection.

Follow these steps to connect to 10BASE-T and 100BASE-TX devices:

- Step 1** When connecting to workstations, servers, routers, and Cisco IP Phones, connect a straight-through Category 5 cable to an RJ-45 connector on the front panel (Figure 2-17). When connecting to switches or repeaters, use a crossover Category 5 cable. Pinouts for the cables are described in the “[Cable and Adapter Specifications](#)” section on page B-4.

Figure 2-17 Connecting to a 10/100 Switch Port

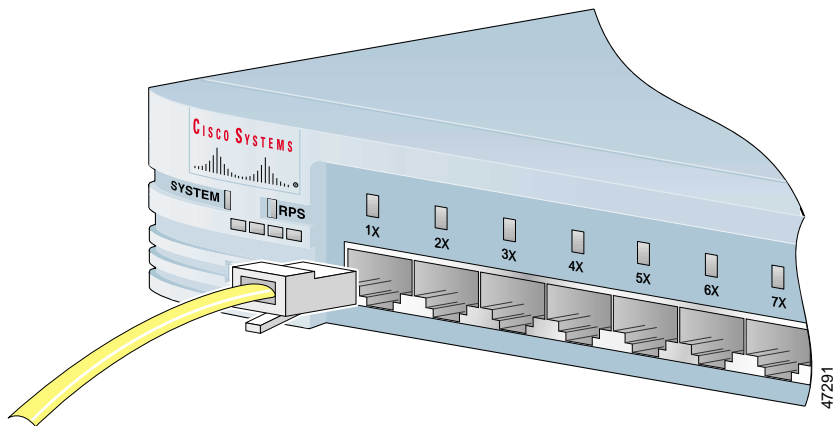

- Note** The switch can connect to a Cisco IP Phone through a straight-through, twisted-pair cable. The rear panel of the Cisco IP Phone might have more than one RJ-45 jack. Use the LAN-to-phone jack to connect the phone to the switch. Refer to the documentation that came with your Cisco IP Phone for information about connecting devices to it.

- Step 2** Connect one end of the cable to the RJ-45 connector of the switch 10/100 port.
- Step 3** Connect the other end of the cable to an RJ-45 connector of the other device.
- The switch port LED comes on when both the switch and the connected device have established link.

The port LED is amber while Spanning Tree Protocol (STP) discovers the topology and searches for loops. This takes about 30 seconds, and then the port LED turns green.

If the port LED does not come on, the device at the other end might not be turned on, or there might be a cable problem or a problem with the adapter installed in the attached device. See [Chapter 3, “Troubleshooting,”](#) for solutions to cabling problems.

- Step 4 Reconfigure and reboot the connected device if necessary.
 - Step 5 Repeat Steps 1 through 3 to connect to each 10/100 port.
-

Connecting to a 100BASE-FX Port



Warning

Invisible laser radiation may be emitted from the aperture ports of the 100BASE-FX single-mode supervisor engine module. Avoid exposure and do not stare into open apertures.



Warning

Avoid exposure to the laser beam.



Caution

Do not remove the rubber plugs from the fiber-optic port or the rubber caps from the fiber-optic cable until you are ready to connect the cable. The plugs and caps protect the fiber-optic port and cable from contamination and ambient light.

You can connect the 100BASE-FX ports to other 100BASE-FX-compatible network devices, such as servers, routers, and other switches. These ports use a duplex SC connector, and you must provide the 50/125- or 62.5/125-micron multimode fiber-optic cable to connect these ports to other 100BASE-FX devices.

The fiber-optic distances between the switch and the attached device follow.

- If the switch port and the port on the attached device are configured for half-duplex operation, the connection can be up to 412 meters.
- If the switch port and the port on the attached device are configured for full-duplex operation, the connection can be up to 2 kilometers.



Note Speed and duplex-mode autonegotiation is not supported on the 100BASE-FX ports.

To connect a switch 100BASE-FX port to another 100BASE-FX device, follow these steps:

- Step 1** Remove the rubber plugs from the port and the rubber caps from the cable connectors.
- Step 2** Connect one end of the fiber-optic cable to the 100BASE-FX port on the switch, as shown in [Figure 2-18](#).

Figure 2-18 Connecting to a 100BASE-FX Switch

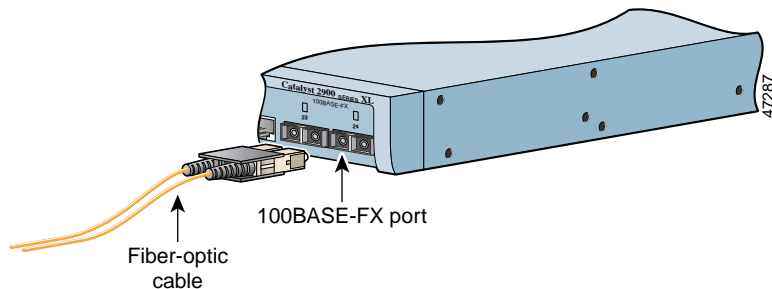

- Step 3** Connect the other end of the cable to the 100BASE-FX port of the other device.
- Step 4** The port LED comes on when both the switch and the connected device have established link.

The port LED is amber while the STP discovers the topology and searches for loops. This takes about 30 seconds, and then the port LED turns green.

If the port does not come on, the device at the other end might not be turned on, or there might be a cable problem or a problem with the adapter installed in the attached device. See Chapter 3, “Troubleshooting,” for solutions to cabling problems.

- Step 5 Reconfigure and reboot the connected device if necessary.
- Step 6 Repeat Steps 1 through 3 to connect each 100BASE-FX port.
-

Connecting to an LRE Port

Depending on the switch model, you can connect the LRE port to either 12 or 24 Cisco 575 LRE customer premises equipment (CPE) devices through a patch panel. If telephone services, such as voice or integrated services digital network (ISDN), use the same cabling as LRE traffic, you must connect the LRE to a *plain old telephone service* (POTS) splitter.



Note

If no other telephone services travel on the same wiring as LRE traffic, the LRE switch connects directly to a patch panel.

Connecting the LRE port to a patch panel or POTS splitter requires a male-to-male RJ-21 cable, category 3 or above. You can order RJ-21 cables from your cable vendor, or you can order these cables from your Cisco sales representative:

- CAB-5-M120M120-5 (Category 5 cable with 90-degree, male-to-male RJ-21 connectors)
- CAB-5-M180120-5 (Category 5 cable with 120-degree, male-to-male RJ-21 connectors)

The screws you need to secure the cable to the switch are shipped with the cable. Contact your Cisco sales representative for more information.

To connect the LRE port to a patch panel or POTS splitter, follow these steps:

-
- Step 1 Connect one end of a wiring trunk cable to the RJ-21 connector of the LRE port on the switch. (See [Figure 2-19](#).)

Figure 2-19 Connecting to an LRE Port

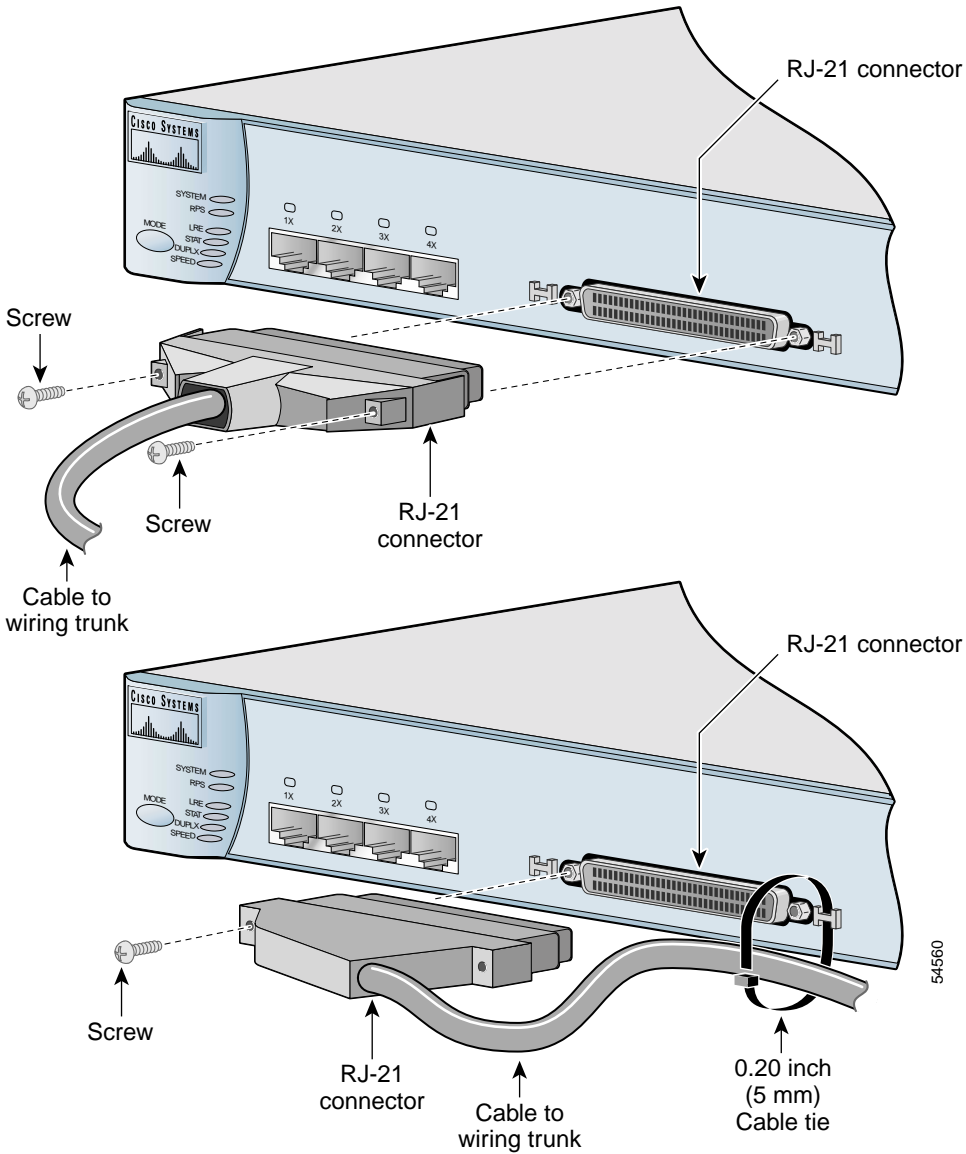

Step 2 Referring to the following figure, secure the cable to the switch:

- For a 90-degree connector, see the top of [Figure 2-19](#).
- For a 12-degree connector, see the bottom [Figure 2-19](#).



Note The cable tie is not included with the connector and cable assembly.

Step 3 Connect the other end of the cable to the patch panel or POTS splitter.

Each LRE port status LED turns on when it establishes a link with a Cisco 575 LRE CPE. For more information about the LRE link between the switch LRE port and the CPE, as well as information about the configuration and management of CPE devices, refer to the *Catalyst 2900 Series XL and Catalyst 3500 Series XL Software Configuration Guide*.

For more information about the Cisco 575 LRE CPE device, refer to the *Cisco 575 LRE CPE Hardware Installation Guide*.

If telephone services, such as voice or ISDN, use the same cabling as LRE traffic, the LRE port must be connected to the patch panel through a basic telephone service, also known as *plain old telephone service* (POTS) splitter. The splitter routes LRE data (high-frequency) and voice (low-frequency) traffic from the telephone line to the switch and private branch exchange (PBX) switch or public-switched telephone network (PSTN).

If the other telephone services are connected through a PBX switch, a Cisco LRE 48 POTS Splitter can be used. The PBX routes voice traffic to private telephone networks and the public system telephone network (PSTN). For more information about the Cisco LRE 48 POTS Splitter (PS-1M-LRE-48), refer to the *Installation Notes for the Cisco LRE 48 POTS Splitter*.

If the installation does not have a PBX, a homologated POTS splitter is required to directly connect to the PSTN. For more information about homologated POTS splitters, contact your Cisco sales representative.



Note If a connection to a phone network is not required at all, a splitter is not needed, and the switch can connect directly to the patch panel.

Connecting to a Module Port

For information about installing and connecting to modules in the Catalyst 2924M XL and 2912MF XL expansion slots, refer to the *Catalyst 2900 Series XL Modules Installation Guide* and the *Catalyst 2900 Series XL ATM Modules Installation and Configuration Guide*.

Connecting to the Console Port

Use the supplied rollover cable and DB-9 adapter to connect a PC to the switch console port. You need to provide a RJ-45-to-DB-25 female DTE adapter if you want to connect the switch console port to a terminal. You can order a kit (part number ACS-DSBUASYN=) containing that adapter from Cisco. For console port and adapter pinout information, see the [“Cable and Adapter Specifications” section on page B-4](#).

The PC or terminal must support VT100 terminal emulation. The terminal-emulation software—frequently a PC application such as Hyperterminal or Procomm Plus—makes communication between the switch and your PC or terminal possible during the setup program.

Follow these steps to connect the PC or terminal to the switch:

-
- Step 1** Configure your PC- or terminal-emulation software to communicate with the switch through hardware flow control.
- Step 2** Configure the baud rate and character format of the PC or terminal to match these switch console port default characteristics:
- 9600 baud
 - 8 data bits
 - 1 stop bit
 - No parity

After you have accessed the switch, you can change the port baud rate back to its original setting. See the *Catalyst 2900 Series XL and Catalyst 3500 Series XL Software Configuration Guide* for instructions.

- Step 3** Using the supplied rollover cable, connect one end of the rollover cable into the console port, as shown in [Figure 2-20](#). See the [“Identifying a Rollover Cable” section on page B-6](#) for a description of the pinout.

Figure 2-20 Connecting to the Console Port

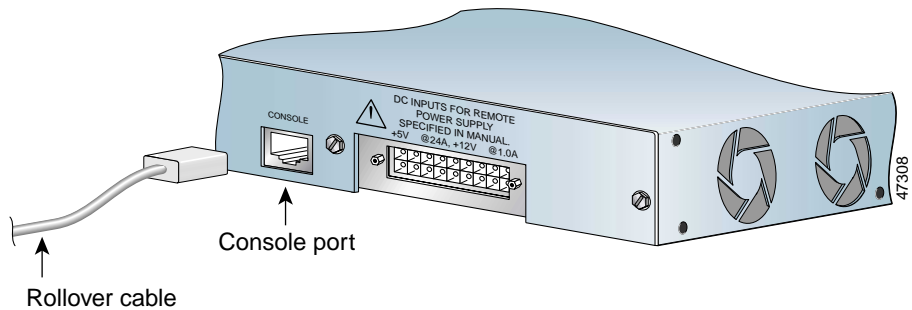

- Step 4** Attach the supplied RJ-45-to-DB-9 female DTE adapter to a PC or attach an appropriate adapter to the terminal.
- Step 5** Connect the other end of the supplied rollover cable to the attached adapter.
- Step 6** Start up the terminal-emulation program.

Where to Go Next

After the switch passes POST, it can operate on its default settings and passwords after you configure IP information on the switch. For information about using the setup program, refer to the *Release Notes for the Catalyst 2900 Series XL and Catalyst 3500 Series XL Cisco IOS Release 12.0(5)WC(1)*.

For information about configuring the switch, refer to the *Catalyst 2900 Series XL and Catalyst 3500 Series XL Software Configuration Guide*.



Troubleshooting

The LEDs on the front panel of the Catalyst 2900 series XL switch provide troubleshooting information about the switch. They show failures in the power-on self-test (POST), port-connectivity problems, and overall switch performance. For a full description of the switch LEDs, see the [“LEDs” section on page 1-9](#).

You can also get statistics from the browser interface, from the command-line interface (CLI), or from an SNMP workstation. See the *Catalyst 2900 Series XL and Catalyst 3500 Series XL Software Configuration Guide*, the *Catalyst 2900 Series XL and Catalyst 3500 Series XL Command Reference*, or the documentation that came with your SNMP application for details.

This chapter describes the following topics for troubleshooting problems:

- Understanding POST Results
- Diagnosing Problems

Understanding POST Results

Each time the switch is powered on, eight POSTs run automatically to check the most important system components before the switch begins forwarding packets. When the switch begins its POST, the port status LEDs turn amber for 2 seconds, and then they turn green. As each test runs, the port status LEDs turn off, starting with number 1x. The port status LEDs for ports 2x to 8x each turn off in turn as the system completes a test.

When the POST completes successfully, the port status LEDs go off, indicating that the switch is operational. If a test fails, the port status LED associated with the test turns amber, and the system LED turns amber. Table 3-1 lists the eight POST tests and their associated LEDs.



Note

POST failures are usually fatal. Call Cisco Systems if your switch does not pass POST.

Table 3-1 *POST Test Descriptions*

Switch LED	Component Tested
1	DRAM
2	Flash memory
3	Switch CPU
4	System board
5	CPU interface ASIC
6	Switch core ASIC
7	Ethernet controller ASIC
8	Ethernet interfaces

Correcting Module POST Failures

If you install modules WS-X2914-XL or WS-X2922-XL in a Catalyst 2924M XL or Catalyst 2912MF XL switch, the module fails POST. This failure occurs because the expansion modules support 2048 MAC addresses and the switch supports 8192 MAC addresses. To correct the failure, restart the switch with the module installed. After the restart, the address capacity of the switch is reduced to 2048 MAC addresses.

Diagnosing Problems

Common switch problems fall into the following categories:

- Poor performance
- No connectivity
- Corrupted software

Table 3-2 describes how to detect and resolve these problems.

Table 3-2 Common Problems and Their Solutions

Symptom	Possible Cause	Resolution
Poor Performance or Excessive Errors.	Duplex autonegotiation mismatch.	Refer to the <i>Catalyst 2900 Series XL and Catalyst 3500 Series XL Software Configuration Guide</i> for information on identifying autonegotiation mismatches.
	<p>Cabling distance exceeded.</p> <ul style="list-style-type: none"> • Port statistics show excessive frame check sequence (FCS), late-collision, or alignment errors. • For 100BASE-TX connections: <ul style="list-style-type: none"> – The distance between the port and the attached device exceeds 328 feet (100 meters). – If the switch is attached to a repeater, the total distance between the two end stations exceeds the 100BASE-T cabling guidelines. • For 10BASE-T connections: The distance between the port and the attached device exceeds 328 feet (100 meters). 	<ul style="list-style-type: none"> • Refer to the <i>Catalyst 2900 Series XL and Catalyst 3500 Series XL Software Configuration Guide</i> for information on displaying port statistics. • Reduce the cable length to within the recommended distances. Refer to your 100BASE-T repeater documentation for cabling guidelines. • Reduce the cable length to within the recommended distances.
	<p>Bad adapter in attached device.</p> <ul style="list-style-type: none"> • Excessive errors found in port statistics. • STP checking for possible loops. 	<ul style="list-style-type: none"> • Run adapter card diagnostic utility. • Wait 30 seconds for LED to turn green.

Table 3-2 Common Problems and Their Solutions (continued)

Symptom	Possible Cause	Resolution
No Connectivity.	<p>Incorrect or bad cable.</p> <p>The following are indicated by no link at both ends:</p> <ul style="list-style-type: none"> • A crossover cable was used when a straight-through was required or vice-versa. • The cable is wired incorrectly. • STP checking for possible loops. 	<ul style="list-style-type: none"> • For the correct pinouts and the proper application of crossover or straight-through cables, see the “Crossover and Straight-Through Cable Pinouts” section on page B-3. • Replace with a tested good cable. • Wait 30 seconds for the LED to turn green.
Amber System LED.	Corrupted software.	Use the EXEC show POST command to see which POST test failed.
Amber Expansion Slot LED.	Module not seated in expansion slot.	Tighten the thumb screws on the module front panel.
Unreadable Characters on the Management Console.	Incorrect baud rate.	Reset the emulation software to 9600 baud.
LRE LED not turned on.	Telephone cable loose or not connected properly.	Reseat phone cable into phone wall jack and Cisco 575 LRE.
	Telephone cable defective.	Replace telephone cable.
	Cable trunking defective.	Repair cable trunking or select an alternative pair.
	Cisco 575 LRECPE not communicating with or might be attempting to exceed bandwidth selected by the Catalyst 2900 LRE XL switch.	Verify switch and upstream network status.

Table 3-2 Common Problems and Their Solutions (continued)

Symptom	Possible Cause	Resolution
LRE status LED not turned on.	RJ-21 cable loose or not connected properly.	Reseat RJ-21 connector and fasten with screw or cable tie.
	Trunk cable defective.	Verify trunk cable, repair or use alternate pair.
	CPE device absent, not powered, or defective.	Check CPE device, and refer to installation guide.
	CPE device out of maximum range.	Consider modification to topology to shorten reach or improve wiring quality.
LRE status LED stays amber.	Trunk quality too poor to support desired profile.	<ul style="list-style-type: none"> Select a lower profile. For more information, refer to the <i>Catalyst 2900 Series XL and Catalyst 3500 Series XL Software Configuration Guide</i>. Assess possibility of improving trunk quality.
	Excessive interference from other services in bundle.	<ul style="list-style-type: none"> Consider use of appropriate public profile in bundles shared with other services. Restrict the use of spectrally incompatible services.other services.
	Local nonstandard noise source.	Consult Cisco sales representative for installation optimization.
LRE link goes down when phone is taken off-hook, placed on-hook, rings, or dials.	Unfiltered phone tap on LRE line.	<ul style="list-style-type: none"> Plug phone into PHONE socket on CPE device. Insert microfilter between phone and LRE line. For more information about microfilters, contact your Cisco sales representative.



Technical Specifications

[Table A-1](#), [Table A-2](#), [Table A-3](#), and [Table A-4](#) list the technical specifications for the Catalyst 2900 series switches.

For switches that support modules (Catalyst 2912MF XL and 2924M XL), also refer to the *Catalyst 2900 Series XL Modules Installation Guide* and the *Catalyst 2900 Series XL ATM Modules Installation Guide* for additional specifications.

[Table A-5](#) lists the agency approvals for EMI and safety.

Table A-1 Technical Specifications for the Catalyst 2912 XL and Catalyst 2912MF XL Switches

	Catalyst 2912 XL	Catalyst 2912MF XL
Environmental Ranges		
Operating temperature	32 to 113°F (0 to 45°C)	32 to 113°F (0 to 45°C)
Storage temperature	-4 to 149°F (-10 to 65°C)	-4 to 149°F (-10 to 65°C)
Operating humidity	10 to 85% (noncondensing)	10 to 85% (noncondensing)
Operating altitude	Up to 10,000 ft (3000 m)	Up to 10,000 ft (3000 m)
Storage altitude	Up to 15,000 ft (4570m)	Up to 15,000 ft (4570 m)
Power Requirements		
AC input voltage	100 to 127/200 to 240 VAC (autoranging) 50 to 60 Hz	100 to 127/200 to 240 VAC (autoranging) 50 to 60 Hz
DC input voltages	+5V ---@9A, +12V ---@0.5A	+5V ---@12A, +12V ---@0.75A +5V ---@22A, +12V ---@0.75A with two modules installed
Power consumption	70W (maximum) 239 Btus per hour	90W (maximum) 307 Btus per hour 170W with two modules installed 580 Btus per hour
Physical Dimensions		
Weight	7 lb (3.2 kg)	14 lb (6.3 kg) 15.5 lb (7.1 kg) with two modules installed
Dimensions (H x W x D)	1.73 x 17.5 x 9.79 in. (4.4 x 44.5 x 24.8 cm)	3.46 x 17.5 x 12 in. (8.8 x 44.5 x 30.5 cm)

Table A-2 Technical Specifications for the Catalyst 2924 XL and Catalyst 2924C XL Switches

	Catalyst 2924 XL	Catalyst 2924C XL
Environmental Operating Ranges		
Operating temperature	32 to 113°F (0 to 45°C)	32 to 113°F (0 to 45°C)
Storage temperature	-4 to 149°F (-10 to 65°C)	-4 to 149°F (-10 to 65°C)
Operating humidity	10 to 85% (noncondensing)	10 to 85% (noncondensing)
Operating altitude	Up to 10,000 ft (3000 m)	Up to 10,000 ft (3000 m)
Storage altitude	Up to 15,000 ft (4570 m)	Up to 15,000 ft (4570 m)
Power Requirements		
AC input voltage	100 to 127/200 to 240 VAC (autoranging) 50 to 60 Hz	100 to 127/200 to 240 VAC (autoranging) 50 to 60 Hz
DC input voltages	+5V ---@9A, +12V ---@0.5A	+5V ---@9A, +12V ---@0.5A
Power consumption	70W (maximum) 239 Btus per hour	70W (maximum) 239 Btus per hour
Physical Dimensions		
Weight	7 lb (3.2 kg)	7 lb (3.2 kg)
Dimensions (H x W x D)	1.73 x 17.5 x 9.79 in. (4.4 x 44.5 x 24.8 cm)	1.73 x 17.5 x 9.79 in. (4.4 x 44.5 x 24.8 cm)
Fiber-Port Power Levels		
Optical transmitter wavelength	—	1300 nm ¹
Optical sensibility of the receiver	—	-14 dBm ²
Optical power transmitter	—	-19 to -14 dBm
Transmit	—	-19 to -14 dBm

1. nm = nanometers

2. dBm = decibel milliwatt

Table A-3 *Technical Specifications for the Catalyst 2924M XL Switches*

Environmental Operating Ranges	
Operating temperature	32 to 113°F (0 to 45°C)
Storage temperature	-4 to 149°F (-10 to 65°C)
Operating humidity	10 to 85% (noncondensing)
Operating altitude	Up to 10,000 ft (3000 m)
Storage altitude	Up to 15,000 ft (4570 m)
Power Requirements	
AC input voltage	100 to 127/200 to 240 VAC (autoranging) 50 to 60 Hz
DC input voltages	+5V _{DC} @ 12A, +12V _{DC} @ 0.55A +5V _{DC} @ 22A, +12V _{DC} @ 0.75A with two modules installed
Power consumption	90W (maximum) 307 Btus per hour 170W with two modules installed 580 Btus per hour
Physical Dimensions	
Weight	13.5 lb (6.12 kg) 15 lb (6.8 kg) with two modules installed
Dimensions (H x W x D)	3.46 x 17.5 x 12 in. (8.8 x 44.5 x 30.5 cm)

Table A-4 *Technical Specifications for the Catalyst 2912 LRE XL and 2924 LRE XL Switches*

Environmental Operating Ranges	
Operating temperature	32 to 113°F (0 to 45°C)
Storage temperature	-13 to 158°F (-25 to 70°C)
Operating humidity	10 to 85% (noncondensing)
Operating altitude	Up to 10,000 ft (3000 m)
Storage altitude	Up to 15,000 ft (4570 m)
Power Requirements	
AC input voltage	100 to 127/200 to 240 VAC (autoranging) 50 to 60 Hz
DC input voltages	+12V --- @12A
Power consumption	150W
Physical Dimensions	
Weight	8.75 (4.00 kg)
Dimensions (H x W x D)	1.75 x 11.82 x 12 in (4.45 x 30.02 x 30.48 cm)

Table A-5 *Catalyst 2900 Series XL Agency Approvals*

Safety	EMI
UL 1950/CSA 22.2 No. 950	FCC Part 15 Class A
IEC 950/EN 60950	EN 55022 Class A (CISPR 22 Class A)
AS/NZS 3260, TS001	VCCI Class A
CE	AS/NZS 3548 Class A
	BCIQ
	CE



Connectors and Cable Specifications

This appendix describes the Catalyst 2900 XL switch ports and the cables and adapters that you use to connect the switch to other devices.

Connector Specifications

10/100 Ports

The 10/100 Ethernet ports use standard RJ-45 connectors and Ethernet pinouts with internal crossovers, as shown by an X in the port name. These ports have their transmit (TD) and receive (RD) signals internally crossed so that a straight-through cable and an adapter can be attached to the port. [Figure B-1](#) shows the pinouts.

Figure B-1 10/100 Port Pinouts

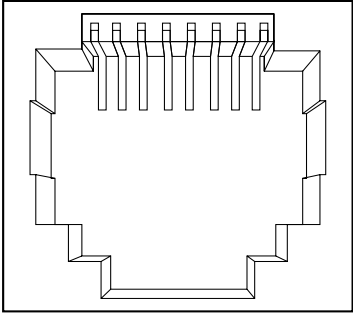
Pin	Label	1 2 3 4 5 6 7 8
1	RD+	
2	RD-	
3	TD+	
4	NC	
5	NC	
6	TD-	
7	NC	
8	NC	

54968

When connecting the 10/100 ports to compatible workstations, servers, routers, and Cisco IP Phones, you must use a straight-through cable wired for 10BASE-T and 100BASE-TX. (Figure B-4 shows the straight-through cable schematics.)

When connecting to other switches or repeaters, you must use a crossover cable. (Figure B-5 shows the crossover cable schematics.)

**Note**

Use a straight-through cable to connect two ports when one of the ports is designated with an **X**. Use a crossover cable to connect two ports when both connectors and cables are designated with an **X** or when both ports do not have an **X**.

100BASE-FX Ports

100BASE-FX ports use duplex SC connectors, as shown in Figure B-2. These ports use 10/125- or 62.5/125-micron multimode fiber-optic cabling.

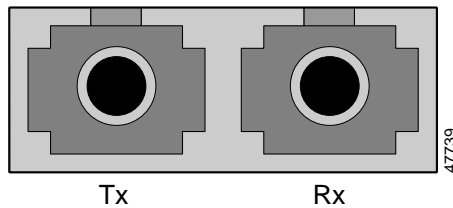
Figure B-2 100BASE-FX SC Connector

LRE Ports

The LRE ports use a single RJ-21 connector, as shown in [Figure B-3](#).

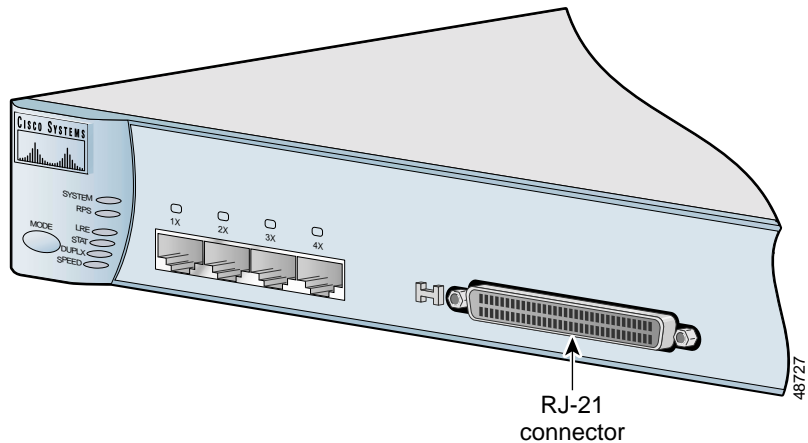
Figure B-3 RJ-21 Connector

Console Port

The console port uses an 8-pin RJ-45 connector, described in [Table B-2](#) and [Table B-3](#). The supplied RJ-45-to-RJ-45 rollover cable and DB-9 adapter are used to connect the console port of the switch to a console PC. You need to provide a RJ-45-to-DB-25 female DTE adapter if you want to connect the switch console

port to a terminal. You can order a kit (part number ACS-DSBUASYN=) containing that adapter from Cisco. For console port and adapter pinout information, see [Table B-2](#) and [Table B-3](#).

Cable and Adapter Specifications

Crossover and Straight-Through Cable Pinouts

The schematics of crossover and straight-through cables are shown in [Figure B-4](#) and [Figure B-5](#).

Figure B-4 *Straight-Through Cable Schematic*

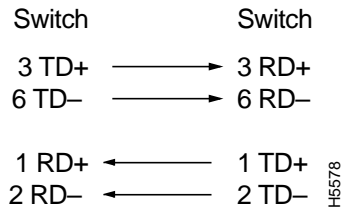
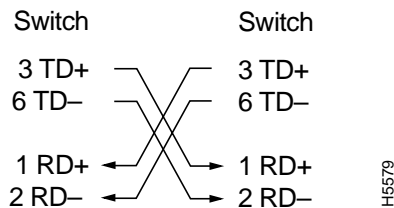

Figure B-5 *Crossover Cable Schematic*



RJ-21 Cable Pinouts

Table B-1 RJ-21 Cable Pinouts

Pins	Circuit	Pins	Circuits
1, 26	1, tip/ring	14, 39	14, tip/ring
2, 27	2, tip/ring	15, 40	15, tip/ring
3, 28	3, tip/ring	16, 41	16, tip/ring
4, 29	4, tip/ring	17, 42	17, tip/ring
5, 30	5, tip/ring	18, 43	18, tip/ring
6, 31	6, tip/ring	19, 44	19, tip/ring
7, 32	7, tip/ring	20, 45	20, tip/ring
8, 33	8, tip/ring	21, 46	21, tip/ring
9, 34	9, tip/ring	22, 47	22, tip/ring
10, 35	10, tip/ring	23, 48	23, tip/ring
11, 36	11, tip/ring	24, 49	25, tip/ring
12, 37	12, tip/ring	25, 50	no connect
13, 38	13, tip/ring		



Note

[Table B-1](#) shows the pinouts for the RJ-21 connector on a Catalyst 2924 LRE XL switch. On a Catalyst 2912 LRE XL switch, only circuits 1 to 12 are valid.

Console Port

The console port uses an 8-pin RJ-45 connector, as shown in [Figure B-7](#) and described in [Table B-2](#). The supplied RJ-45-to-RJ-45 rollover cable and adapters connect the console port of the switch to a console PC or terminal. The following sections describe the rollover cable and adapters for the console port.

Identifying a Rollover Cable

You can identify a rollover cable by comparing the two modular ends of the cable. Hold the cable ends side-by-side, with the tab at the back. The wire connected to the pin on the outside of the left plug should be the same color as the wire connected to the pin on the outside of the right plug (see [Figure B-6](#)).

Figure B-6 Identifying a Rollover Cable

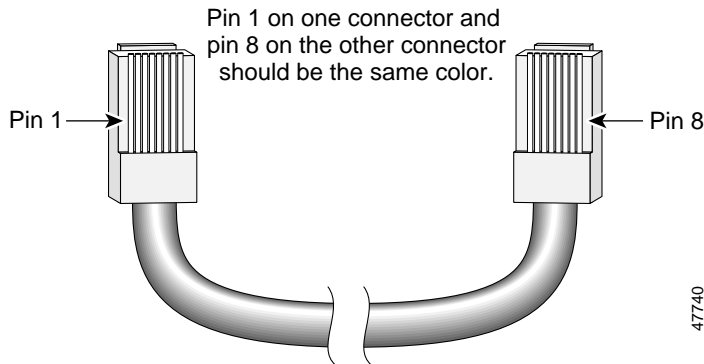

Connecting to a PC

Use the thin, flat, RJ-45-to-RJ-45 rollover cable and RJ-45-to-DB-9 female DTE adapter (both provided) to connect the console port to a PC running terminal-emulation software. [Figure B-7](#) shows how to connect the console port to a PC. [Table B-2](#) lists the pinouts for the console port, the RJ-45-to-RJ-45 rollover cable, and the RJ-45-to-DB-9 female DTE adapter.

Figure B-7 Connecting the Console Port to a PC

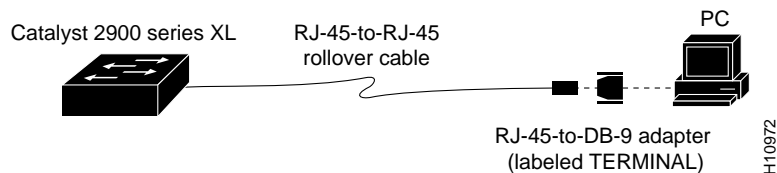

Table B-2 Console Port Signaling and Cabling Using a DB-9 Adapter

Console Port (DTE)	RJ-45-to-RJ-45 Rollover Cable		RJ-45-to-DB-9 Terminal Adapter	Console Device
Signal	RJ-45 Pin	RJ-45 Pin	DB-9 Pin	Signal
RTS	1	8	8	CTS
Not connected	2	7	6	DSR
TxD	3	6	2	RxD
GND	4	5	5	GND
GND	5	4	5	GND
RxD	6	3	3	TxD
Not connected	7	2	4	DTR
CTS	8	1	7	RTS

Connecting to a Terminal

Use the thin, flat, RJ-45-to-RJ-45 rollover cable and RJ-45-to-DB-25 female DTE adapter to connect the console port to a terminal. [Table B-3](#) lists the pinouts for the console port, the RJ-45-to-RJ-45 rollover cable, and the RJ-45-to-DB-25 female DTE adapter.



Note

The RJ-45-to-DB-25 female DTE adapter is not supplied with the switch. You can order a kit (part number ACS-DSBUASYN=) containing this adapter from Cisco.

Table B-3 Console Port Signaling and Cabling Using a DB-25 Adapter

Console Port (DTE)	RJ-45-to-RJ-45 Rollover Cable		RJ-45-to-DB-25 Terminal Adapter	Console Device
Signal	RJ-45 Pin	RJ-45 Pin	DB-25 Pin	Signal
RTS	1	8	5	CTS
Not connected	2	7	6	DSR
TxD	3	6	3	RxD
GND	4	5	7	GND
GND	5	4	7	GND
RxD	6	3	2	TxD
Not connected	7	2	20	DTR
CTS	8	1	4	RTS



Translated Safety Warnings

This appendix repeats in multiple languages the warnings in this guide. These translated warnings can be used with other documents related to this guide.

Attaching the Cisco RPS (model PWR600-AC-RPS)

This warning applies to the Catalyst 2912 XL, 2924 XL, 2924C XL, 2924M XL, and 2924C XL switches.



Warning

Attach only the Cisco RPS (model PWR600-AC-RPS) to the RPS receptacle.

Waarschuwing:

Slechts de Cisco RPS (model PWR600-AC-RPS) aan de RPS contactdoos verbinden.

Varoitus

Kiinnitä RPS-vastakappaleeseen vain Cisco RPS (malli PWR600-AC-RPS).

Avertissement :

Raccordez le bloc d'alimentation Cisco RPS (modèle PWR600-AC-RPS) uniquement au connecteur RPS.

Warnung:

An die RPS-Steckhülse darf nur das Cisco RPS (Modell PWR600-AC-RPS) angeschlossen werden.

Avvertenza.

Collegare soltanto il Cisco RPS (modello PWR600-AC-RPS) alla presa RPS.

Advarsel!

Koble bare Cisco RPS (modell PWR600-AC-RPS) til RPS-stikkontakten.

Aviso

Anexe o RPS Cisco (modelo PWR600-AC-RPS) apenas ao receptáculo RPS.

Aviso:

Sólo conecte el Cisco RPS (modelo PWR600-AC-RPS) al receptáculo RPS.

Varning!

Koppla endast Ciscos RPS (modell PWR600-AC-RPS) till RPS-uttaget.

Attaching the Cisco RPS (model PWR300-AC-RPS-N1)

This warning applies to the Catalyst 2912 LRE XL and 2924 LRE XL switches.



Warning

Attach only the Cisco RPS (model PWR300-AC-RPS-N1) to the RPS receptacle.

Waarschuwing:

Slechts de Cisco RPS (model PWR300-AC-RPS-N1) aan de RPS contactdoos verbinden.

Varoitus

Kiinnitä RPS-vastakappaleeseen vain Cisco RPS (malli PWR300-AC-RPS-N1).

Avertissement :

Raccordez le bloc d'alimentation Cisco RPS (modèle PWR300-AC-RPS-N1) uniquement au connecteur RPS

Warnung:

An die RPS-Steckhülse darf nur das Cisco RPS (Modell PWR300-AC-RPS-N1) angeschlossen werden.

Avvertenza.

Collegare soltanto il Cisco RPS (modello PWR300-AC-RPS-N1) alla presa RPS.

Advarsel!

Koble bare Cisco RPS (modell PWR300-AC-RPS-N1) til RPS-stikkontakten.

Aviso

Anexe o RPS Cisco (modelo PWR300-AC-RPS-N1) apenas ao receptáculo RPS.

Aviso:

Sólo conecte el Cisco RPS (modelo PWR300-AC-RPS-N1) al receptáculo RPS.

Varning!

Koppla endast Ciscos RPS (modell PWR300-AC-RPS-N1) till RPS-uttaget.

Qualified Personnel Warning



Warning

Only trained and qualified personnel should be allowed to install or replace this equipment

Waarschuwing

Installatie en reparaties mogen uitsluitend door getraind en bevoegd personeel uitgevoerd worden.

Varoitus

Ainoastaan koulutettu ja pätevä henkilökunta saa asentaa tai vaihtaa tämän laitteen.

Avertissement

Tout installation ou remplacement de l'appareil doit être réalisé par du personnel qualifié et compétent.

Achtung

Gerät nur von geschultem, qualifiziertem Personal installieren oder auswechseln lassen.

Avvertenza

Solo personale addestrato e qualificato deve essere autorizzato ad installare o sostituire questo apparecchio.

Advarsel

Kun kvalifisert personell med riktig opplæring bør montere eller bytte ut dette utstyret.

Aviso

Este equipamento deverá ser instalado ou substituído apenas por pessoal devidamente treinado e qualificado.

¡Atención!

Estos equipos deben ser instalados y reemplazados exclusivamente por personal técnico adecuadamente preparado y capacitado.

Varning

Denna utrustning ska endast installeras och bytas ut av utbildad och kvalificerad personal.

Installation Warning



Warning

Read the installation instructions before you connect the system to its power source.

Waarschuwing

Raadpleeg de installatie-aanwijzingen voordat u het systeem met de voeding verbindt.

Varoitus

Lue asennusohjeet ennen järjestelmän yhdistämistä virtalähteeseen.

Attention

Avant de brancher le système sur la source d'alimentation, consulter les directives d'installation.

Warnung

Lesen Sie die Installationsanweisungen, bevor Sie das System an die Stromquelle anschließen.

Avvertenza

Consultare le istruzioni di installazione prima di collegare il sistema all'alimentatore.

Advarsel

Les installasjonsinstruksjonene før systemet kobles til strømkilden.

Aviso

Leia as instruções de instalação antes de ligar o sistema à sua fonte de energia.

¡Advertencia!

Ver las instrucciones de instalación antes de conectar el sistema a la red de alimentación.

Varning!

Läs installationsanvisningarna innan du kopplar systemet till dess strömförsörjningsenhet.

警告 システムを電源に接続する前に、インストラクションについての説明書を必ずお読みください。

Jewelry Removal Warning



Warning

Before working on equipment that is connected to power lines, remove jewelry (including rings, necklaces, and watches). Metal objects will heat up when connected to power and ground and can cause serious burns or weld the metal object to the terminals.

Waarschuwing

Alvorens aan apparatuur te werken die met elektrische leidingen is verbonden, sieraden (inclusief ringen, kettingen en horloges) verwijderen. Metalen voorwerpen worden warm wanneer ze met stroom en aarde zijn verbonden, en kunnen ernstige brandwonden veroorzaken of het metalen voorwerp aan de aansluitklemmen lassen.

Varoitus

Ennen kuin työskentelet voimavirtajohtoihin kytkettyjen laitteiden parissa, ota pois kaikki korut (sormukset, kaulakorut ja kellot mukaan lukien). Metalliesineet kuumenevat, kun ne ovat yhteydessä sähkövirran ja maan kanssa, ja ne voivat aiheuttaa vakavia palovammoja tai hitsata metalliesineet kiinni liitäntänapoihin.

Attention

Avant d'accéder à cet équipement connecté aux lignes électriques, ôter tout bijou (anneaux, colliers et montres compris). Lorsqu'ils sont branchés à l'alimentation et reliés à la terre, les objets métalliques chauffent, ce qui peut provoquer des blessures graves ou souder l'objet métallique aux bornes.

Warnung

Vor der Arbeit an Geräten, die an das Netz angeschlossen sind, jeglichen Schmuck (einschließlich Ringe, Ketten und Uhren) abnehmen. Metallgegenstände erhitzen sich, wenn sie an das Netz und die Erde angeschlossen werden, und können schwere Verbrennungen verursachen oder an die Anschlußklemmen angeschweißt werden.

- Avvertenza** Prima di intervenire su apparecchiature collegate alle linee di alimentazione, togliersi qualsiasi monile (inclusi anelli, collane, braccialetti ed orologi). Gli oggetti metallici si riscaldano quando sono collegati tra punti di alimentazione e massa: possono causare ustioni gravi oppure il metallo può saldarsi ai terminali.
- Advarsel** Fjern alle smykker (inkludert ringer, halskjeder og klokker) før du skal arbeide på utstyr som er koblet til kraftledninger. Metallgjenstander som er koblet til kraftledninger og jord blir svært varme og kan forårsake alvorlige brannskader eller smelte fast til polene.
- Aviso** Antes de trabalhar em equipamento que esteja ligado a linhas de corrente, retire todas as jóias que estiver a usar (incluindo anéis, fios e relógios). Os objectos metálicos aquecerão em contacto com a corrente e em contacto com a ligação à terra, podendo causar queimaduras graves ou ficarem soldados aos terminais.
- ¡Advertencia!** Antes de operar sobre equipos conectados a líneas de alimentación, quitarse las joyas (incluidos anillos, collares y relojes). Los objetos de metal se calientan cuando se conectan a la alimentación y a tierra, lo que puede ocasionar quemaduras graves o que los objetos metálicos queden soldados a los bornes.
- Varning!** Tag av alla smycken (inklusive ringar, halsband och armbandsur) innan du arbetar på utrustning som är kopplad till kraftledningar. Metallobjekt hettas upp när de kopplas ihop med ström och jord och kan förorsaka allvarliga brännskador; metallobjekt kan också sammansvetsas med kontakterna.
-

Stacking the Chassis Warning



Warning

Do not stack the chassis on any other equipment. If the chassis falls, it can cause severe bodily injury and equipment damage.

Waarschuwing

Het chassis mag niet op andere apparatuur gestapeld te worden. Als het chassis mocht vallen, kan dit ernstig lichamelijk letsel en beschadiging van de apparatuur veroorzaken.

Varoitus

Älä aseta asennuspohjaa minkään muun laitteen päälle. Asennuspohja voi pudotessaan aiheuttaa vaikean ruumiinvamman tai laitevaurion.

Avertissement

Ne placez pas ce châssis sur un autre appareil. En cas de chute, il pourrait provoquer de graves blessures corporelles et d'importants dommages.

Achtung

Das Gehäuse nicht auf andere Geräte stellen. Wenn das Gehäuse herunterfällt, besteht Gefahr schwerer Personenverletzungen und Geräteschäden.

Avvertenza

Non collocare lo chassis su nessun altro apparecchio. Se lo chassis cade, può causare lesioni gravi e danni alle apparecchiature.

Advarsel

Stable ikke kabinettet oppå annet utstyr. Hvis kabinettet faller, kan det forårsake alvorlig skade på mennesker og utstyr.

Aviso

Não coloque o chassis em cima de qualquer outro equipamento. Se o chassis cair, poderá causar ferimentos graves e danos no equipamento.

- ¡Atención!** No apilar los chasis sobre ningún otro equipo. Si el chasis se cae al suelo puede causar graves lesiones físicas y daños al equipo.
- Varning** Placera inte chassit ovanpå annan utrustning. Om chassit faller kan allvarlig kroppsskada såväl som skada på utrustningen uppstå.
-

Main Disconnecting Device



Warning

The plug-socket combination must be accessible at all times because it serves as the main disconnecting device.

Waarschuwing

De combinatie van de stekker en het elektrisch contactpunt moet te allen tijde toegankelijk zijn omdat deze het hoofdmechanisme vormt voor verbreking van de aansluiting.

Varoitus

Pistoke/liitinkohta toimii pääkatkaisumekanismina. Pääsy siihen on pidettävä aina esteettömänä.

Attention

La combinaison de prise de courant doit être accessible à tout moment parce qu'elle fait office de système principal de déconnexion.

Warnung

Der Netzkabelanschluß am Gerät muß jederzeit zugänglich sein, weil er als primäre Ausschaltvorrichtung dient.

Avvertenza

Il gruppo spina-presa deve essere sempre accessibile, poiché viene utilizzato come dispositivo di scollegamento principale.

Advarsel

Kombinasjonen støpsel/uttak må alltid være tilgjengelig ettersom den fungerer som hovedfrakoplingsenhet.

Overtemperature Warning

- Aviso** A combinação ficha-tomada deverá ser sempre acessível, porque funciona como interruptor principal.
- ¡Advertencia!** El conjunto de clavija y toma ha de encontrarse siempre accesible ya que hace las veces de dispositivo de desconexión principal.
- Varning!** Man måste alltid kunna komma åt stickproppen i uttaget, eftersom denna koppling utgör den huvudsakliga fränkopplingsanordningen.
-

Overtemperature Warning



Warning

To prevent the switch from overheating, do not operate it in an area that exceeds the maximum recommended ambient temperature of 104°F (40°C). To prevent airflow restriction, allow at least 3 inches (7.6 cm) of clearance around the ventilation openings.

Waarschuwing

Om oververhitting van de schakelaar te voorkomen, mag u die niet bedienen in een ruimte die de maximale aanbevolen omgevingstemperatuur van 104 F (40°C) overschrijdt. Om beperking van de luchtstroom te voorkomen, dient u ten minste 3 inch (7,6 cm) speling te laten rondom de ventilatie-openingen.

Varoitus

Estääksesi kytkimen ylikuumentumisen älä käytä sitä sellaisissa paikoissa, joiden lämpötila ylittää ympäristön enimmäislämpötilaksi suositellun 40°C. Jätä vähintään 7,6 cm:n vapaa tila tuuletusaukkojen ympärille, jotta ilma pääsee vapaasti virtaamaan.

- Attention** Pour éviter une surchauffe du commutateur, ne pas le faire fonctionner dans un local dont la température ambiante dépasse le maximum recommandé de 40°C (104 F). Pour faciliter la circulation d'air, aménager un dégagement d'au moins 7,6 cm (3 pouces) autour des bouches d'aération.
- Warnung** Um eine Überhitzung des Schalters zu vermeiden, ist das System nicht in einem Bereich zu betreiben, in dem die empfohlene Höchsttemperatur von 40°C überschritten wird. Damit der Luftfluß nicht behindert wird, ist ein Freiraum von mindestens 7,6 cm um die Belüftungsöffnungen herum einzuhalten.
- Avvertenza** Per evitare il surriscaldamento dell'interruttore, non usare l'apparecchiatura in un'area che supera la temperatura ambientale minima consigliata di 40°C. Per evitare una limitazione del flusso dell'aria, lasciare come minimo uno spazio libero di 7,6 cm intorno alle aperture di ventilazione.
- Advarsel** For å unngå at bryteren overopphetes skal utstyret ikke brukes på steder hvor anbefalt maks omgivelsestemperatur overstiger 104 grader Farenheit (40°C). La det være minst 3 tommer (7,6 cm) klaring rundt ventilasjonsåpningene for at luftsirkulasjonen skal være uhindret.
- Aviso** Para evitar sobreaquecimento do interruptor, não utilize o equipamento numa área que exceda uma temperatura máxima de 40°C. Para evitar o bloqueamento da circulação de ar, deixe pelo menos um espaço de 7.6 cm em volta das aberturas de ventilação.

Overtemperature Warning

¡Advertencia! Para evitar que el interruptor se recaliente, no se debe usar en áreas cuya temperatura ambiente exceda la máxima recomendada, esto es, 40°C (104°F). Para no entorpecer la corriente de aire, dejar por lo menos 7,6 cm (3 pulgadas) de espacio muerto alrededor de la rejilla de ventilación.

Varning! För att undvika överhettning av strömbrytaren skall den inte användas i utrymme vars temperatur överskrider den maximalt rekommenderade omgivningstemperaturen 40°C. Kontrollera att det finns minst 7,6 cm fritt utrymme runt ventilationsöppningarna så att luftflödet inte begränsas.

TN Power Warning



Warning The device is designed to work with TN power systems.

Waarschuwing Het apparaat is ontworpen om te functioneren met TN energiesystemen.

Varoitus Koje on suunniteltu toimimaan TN-sähkövoimajärjestelmien yhteydessä.

Attention Ce dispositif a été conçu pour fonctionner avec des systèmes d'alimentation TN.

Warnung Das Gerät ist für die Verwendung mit TN-Stromsystemen ausgelegt.

Avvertenza Il dispositivo è stato progettato per l'uso con sistemi di alimentazione TN.

Advarsel Utstyret er utfomet til bruk med TN-strømsystemer.

Aviso O dispositivo foi criado para operar com sistemas de corrente TN.

¡Advertencia! El equipo está diseñado para trabajar con sistemas de alimentación tipo TN.

Varning! Enheten är konstruerad för användning tillsammans med elkraftssystem av TN-typ.

Ground Connection Warning



Warning

When installing the unit, the ground connection must always be made first and disconnected last.

Waarschuwing

Bij de installatie van het toestel moet de aardverbinding altijd het eerste worden gemaakt en het laatste worden losgemaakt.

Varoitus

Laitetta asennettaessa on maahan yhdistäminen aina tehtävä ensiksi ja maadoituksen irti kytkeminen viimeiseksi.

Attention

Lors de l'installation de l'appareil, la mise à la terre doit toujours être connectée en premier et déconnectée en dernier.

Warnung

Der Erdanschluß muß bei der Installation der Einheit immer zuerst hergestellt und zuletzt abgetrennt werden.

Avvertenza

In fase di installazione dell'unità, eseguire sempre per primo il collegamento a massa e disconnetterlo per ultimo.

Advarsel

Når enheten installeres, må jordledningen alltid tilkobles først og frakobles sist.

Aviso

Ao instalar a unidade, a ligação à terra deverá ser sempre a primeira a ser ligada, e a última a ser desligada.

¡Advertencia!

Al instalar el equipo, conectar la tierra la primera y desconectarla la última.

Varning!

Vid installation av enheten måste jordledningen alltid anslutas först och kopplas bort sist.

Circuit Breaker (15A) Warning



This product relies on the building's installation for short-circuit (overcurrent) protection. Ensure that a fuse or circuit breaker no larger than 120 VAC, 15A U.S. (240 VAC, 16A international) is used on the phase conductors (all current-carrying conductors).

Waarschuwing

Dit produkt is afhankelijk van de installatie van het gebouw voor kortsluit- (overstroom)beveiliging. Controleer of er een zekering of stroomverbreker van niet meer dan 120 Volt wisselstroom, 15 A voor de V.S. (240 Volt wisselstroom, 16 A internationaal) gebruikt wordt op de fasegeleiders (alle geleiders die stroom voeren).

Varoitus

Tämä tuote on riippuvainen rakennukseen asennetusta oikosulkusuojauksesta (ylivirtasuojauksesta). Varmista, että vaihevirtajohtimissa (kaikissa virroitetuissa johtimissa) käytetään Yhdysvalloissa alle 120 voltin, 15 ampeerin ja monissa muissa maissa 240 voltin, 16 ampeerin sulaketta tai suojakytintä.

Attention

Pour ce qui est de la protection contre les courts-circuits (surtension), ce produit dépend de l'installation électrique du local. Vérifier qu'un fusible ou qu'un disjoncteur de 120 V alt., 15 A U.S. maximum (240 V alt., 16 A international) est utilisé sur les conducteurs de phase (conducteurs de charge).

Warnung

Dieses Produkt ist darauf angewiesen, daß im Gebäude ein Kurzschluß- bzw. Überstromschutz installiert ist. Stellen Sie sicher, daß eine Sicherung oder ein Unterbrecher von nicht mehr als 240 V Wechselstrom, 16 A (bzw. in den USA 120 V Wechselstrom, 15 A) an den Phasenleitern (allen stromführenden Leitern) verwendet wird.

■ Circuit Breaker (15A) Warning

- Avvertenza** Questo prodotto dipende dall'installazione dell'edificio per quanto riguarda la protezione contro cortocircuiti (sovracorrente). Verificare che un fusibile o interruttore automatico, non superiore a 120 VCA, 15 A U.S. (240 VCA, 16 A internazionale) sia stato usato nei fili di fase (tutti i conduttori portatori di corrente).
- Advarsel** Dette produktet er avhengig av bygningens installasjoner av kortslutningsbeskyttelse (overstrøm). Kontroller at det brukes en sikring eller strømbryter som ikke er større enn 120 VAC, 15 A (USA) (240 VAC, 16 A internasjonalt) på faselederne (alle strømførende ledere).
- Aviso** Este produto depende das instalações existentes para protecção contra curto-circuito (sobrecarga). Assegure-se de que um fusível ou disjuntor não superior a 240 VAC, 16A é utilizado nos condutores de fase (todos os condutores de transporte de corrente).
- ¡Advertencia!** Este equipo utiliza el sistema de protección contra cortocircuitos (o sobrecorrientes) del propio edificio. Asegurarse de que se utiliza un fusible o interruptor automático de no más de 240 voltios en corriente alterna (VAC), 16 amperios del estándar internacional (120 VAC, 15 amperios del estándar USA) en los hilos de fase (todos aquellos portadores de corriente).
- Varning!** Denna produkt är beroende av i byggnaden installerat kortslutningsskydd (överströmsskydd). Kontrollera att säkring eller överspänningsskydd används på fasledarna (samliga strömförande ledare) för internationellt bruk max. 240 V växelström, 16 A (i USA max. 120 V växelström, 15 A).

Grounded Equipment Warning



Warning

This equipment is intended to be grounded. Ensure that the host is connected to earth ground during normal use.

Waarschuwing

Deze apparatuur hoort geaard te worden. Zorg dat de host-computer tijdens normaal gebruik met aarde is verbonden.

Varoitus

Tämä laitteisto on tarkoitettu maadoitettavaksi. Varmista, että isäntälaitte on yhdistetty maahan normaalikäytön aikana.

Attention

Cet équipement doit être relié à la terre. S'assurer que l'appareil hôte est relié à la terre lors de l'utilisation normale.

Warnung

Dieses Gerät muß geerdet werden. Stellen Sie sicher, daß das Host-Gerät während des normalen Betriebs an Erde gelegt ist.

Avvertenza

Questa apparecchiatura deve essere collegata a massa. Accertarsi che il dispositivo host sia collegato alla massa di terra durante il normale utilizzo.

Advarel

Dette utstyret skal jordes. Forviss deg om vertsterminalen er jordet ved normalt bruk.

Aviso

Este equipamento deverá estar ligado à terra. Certifique-se que o host se encontra ligado à terra durante a sua utilização normal.

¡Advertencia!

Este equipo debe conectarse a tierra. Asegurarse de que el equipo principal esté conectado a tierra durante el uso normal.

Varning!

Denna utrustning är avsedd att jordas. Se till att värdenheten är jordad vid normal användning.

Supply Circuit Warning

警告 この装置はアースを必要とするものです。通常動作時は、ホストがアースされていることを確認してください。

Supply Circuit Warning



Warning

Care must be given to connecting units to the supply circuit so that wiring is not overloaded.

Waarschuwing

Let erop dat de toestellen op voedingscircuits worden aangesloten zonder het vermogen van de bedrading te overschrijden.

Varoitus

Laiteyksiköt on yhdistettävä huolellisesti syöttöpiiriin niin, että johdot eivät ole ylikuormitettuja.

Avertissement

Veillez à bien connecter les unités au circuit d'alimentation afin de ne pas surcharger les connections.

Achtung

Beim Anschließen der Geräte an das Stromnetz ist darauf zu achten, daß die Schaltverbindungen nicht überlastet werden.

Avvertenza

Fare attenzione quando si collegano le unità al circuito di alimentazione, per non sovraccaricare i cablaggi.

Advarsel

Vær nøye med å koble enheter til strømforsyningskretsen slik at ledningene ikke overbelastes.

Aviso

Deverá ter precaução ao ligar unidades ao circuito de fornecimento de energia, para não sobrecarregar a instalação.

- ¡Atención! Poner mucho cuidado al conectar los equipos al circuito de alimentación a fin de no sobrecargar el cableado.
- Varning Var noga vid anslutning av enheter till matarströmkretsen så att ledningarna inte överbelastas.
-

Voltage Warning



Warning

A voltage mismatch can cause equipment damage and may pose a fire hazard. If the voltage indicated on the label is different from the power outlet voltage, *do not connect the chassis to that receptacle.*

Waarschuwing

Aansluiting op een verkeerd voedingsvoltage kan beschadiging van de apparatuur veroorzaken en tot brandgevaar leiden. *Het chassis mag niet aangesloten worden als de spanning die op het label staat aangegeven, anders is dan de spanning van het stopcontact.*

Varoitus

Erisuuruisten jännitteiden yhdistäminen voi aiheuttaa laiteaurion ja tulipalon vaaran. Jos tarraan merkitty jännite eroaa pistorasian jännitteestä, *älä yhdistä asennuspohjaa pistorasiaan.*

Avertissement

Une erreur de voltage risque d'endommager l'appareil et constitue un risque d'incendie. Si la tension indiquée sur l'étiquette est différente de la tension de l'alimentation, *ne connectez en aucun cas le châssis à la prise.*

Achtung

Bei nicht übereinstimmender Spannung kann es zu Geräteschäden und Feuergefahr kommen. Wenn die auf dem Etikett angegebene Spannung nicht mit der Steckdosenspannung übereinstimmt, schließen Sie das Gerät nicht an diese Steckdose an.

■ Voltage Warning

- Avvertenza** **Una tensione inadeguata può causare danni all'apparecchio e rischio di incendio. Se la tensione riportata sulla targhetta è diversa da quella della presa di alimentazione, *non collegare lo chassis a tale presa.***
- Advarsel** **Ulik spenning kan forårsake skade på utstyret og innebære brannfare. Dersom spenningen på merkelappen er forskjellig fra spenningen i stikkkontakten, *må du ikke koble kabinettet til den stikkkontakten.***
- Aviso** **Uma voltagem incorrecta poderá causar danos no equipamento e constituir um risco de incêndio. Se a voltagem indicada na etiqueta for diferente da voltagem de saída de corrente da parede, *não ligue o chassis a esse receptáculo.***
- ¡Atención!** **Las diferencias en el voltaje pueden causar daños a los equipos y presentar peligro de incendio. Si el voltaje indicado en la etiqueta es diferente al de la toma de alimentación, no conectar el chasis a dicha toma.**
- Varning** **Inkompatibla spänningar kan resultera i materiella skador samt utgör brandfara. Om den spänning som anges på etiketten skiljer sig från strömuttagets spänning *ska chassit inte anslutas till detta uttag.***
-

Power Supply Warning

**Warning**

Do not touch the power supply when the power cord is connected. For systems with a power switch, line voltages are present within the power supply even when the power switch is off and the power cord is connected. For systems without a power switch, line voltages are present within the power supply when the power cord is connected.

Waarschuwing

U dient de voeding niet aan te raken zolang het netsnoer aangesloten is. Bij systemen met een stroomschakelaar zijn er lijnspanningen aanwezig in de voeding, zelfs wanneer de stroomschakelaar uitgeschakeld is en het netsnoer aangesloten is. Bij systemen zonder een stroomschakelaar zijn er lijnspanningen aanwezig in de voeding wanneer het netsnoer aangesloten is.

Varoitus

Älä kosketa virtalähdettä virtajohdon ollessa kytkettynä. Virrankatkaisimella varustetuissa järjestelmissä on virtalähteen sisällä jäljellä verkkojännite, vaikka virrankatkaisin on katkaistu-asennossa virtajohdon ollessa kytkettynä. Järjestelmissä, joissa ei ole virrankatkaisinta, on virtalähteen sisällä verkkojännite, kun virtajohto on kytkettynä.

Attention

Ne pas toucher le bloc d'alimentation quand le cordon d'alimentation est branché. Avec les systèmes munis d'un commutateur marche-arrêt, des tensions de ligne sont présentes dans l'alimentation quand le cordon est branché, même si le commutateur est à l'arrêt. Avec les systèmes sans commutateur marche-arrêt, l'alimentation est sous tension quand le cordon d'alimentation est branché.

Warnung

Berühren Sie das Netzgerät nicht, wenn das Netzkabel angeschlossen ist. Bei Systemen mit Netzschalter liegen Leitungsspannungen im Netzgerät vor, wenn das Netzkabel angeschlossen ist, auch wenn das System ausgeschaltet ist. Bei Systemen ohne Netzschalter liegen Leitungsspannungen im Netzgerät vor, wenn das Netzkabel angeschlossen ist.

■ Power Supply Warning

- Avvertenza** Non toccare l'alimentatore se il cavo dell'alimentazione è collegato. Per i sistemi con un interruttore di alimentazione, tensioni di linea sono presenti all'interno dell'alimentatore anche quando l'interruttore di alimentazione è in posizione di disattivazione (off), se il cavo dell'alimentazione è collegato. Per i sistemi senza un interruttore, tensioni di linea sono presenti all'interno dell'alimentatore quando il cavo di alimentazione è collegato.
- Advarsel** Berør ikke strømforsyningsenheden når strømledningen er tilkoblet. I systemer som har en strømbryter, er det spenning i strømforsyningsenheden selv om strømbryteren er slått av og strømledningen er tilkoblet. Når det gjelder systemer uten en strømbryter, er det spenning i strømforsyningsenheden når strømledningen er tilkoblet.
- Aviso** Não toque na unidade abastecedora de energia quando o cabo de alimentação estiver ligado. Em sistemas com interruptor, a corrente eléctrica estará presente na unidade abastecedora, sempre que o cabo de alimentação de energia estiver ligado, mesmo quando o interruptor se encontrar desligado. Para sistemas sem interruptor, a tensão eléctrica dentro da unidade abastecedora só estará presente quando o cabo de alimentação estiver ligado.
- ¡Advertencia!** No tocar la fuente de alimentación mientras el cable esté enchufado. En sistemas con interruptor de alimentación, hay voltajes de línea dentro de la fuente, incluso cuando el interruptor esté en Apagado (OFF) y el cable de alimentación enchufado. En sistemas sin interruptor de alimentación, hay voltajes de línea en la fuente cuando el cable está enchufado.
- Varning!** Vidrör inte strömförsörjningsenheden när nätsladden är ansluten. För system med strömbrytare finns det nätspänning i strömförsörjningsenheden även när strömmen har slagits av men nätsladden är ansluten. För system utan strömbrytare finns det nätspänning i strömförsörjningsenheden när nätsladden är ansluten.
-

警告 電源コードが接続されているときは電源に触れないでください。電源スイッチの付いた装置で電源コードが接続されているときは、電源スイッチがオフでもライン電圧が電源内に存在します。電源スイッチのないシステムで電源コードが接続されているときは、ライン電圧が電源内に存在します。

Lightning Activity Warning



Warning

Do not work on the system or connect or disconnect cables during periods of lightning activity.

Waarschuwing

Tijdens onweer dat gepaard gaat met bliksem, dient u niet aan het systeem te werken of kabels aan te sluiten of te ontkoppelen.

Varoitus

Älä työskentele järjestelmän parissa äläkä yhdistä tai irrota kaapeleita ukkosilmalla.

Attention

Ne pas travailler sur le système ni brancher ou débrancher les câbles pendant un orage.

Warnung

Arbeiten Sie nicht am System und schließen Sie keine Kabel an bzw. trennen Sie keine ab, wenn es gewittert.

Avvertenza

Non lavorare sul sistema o collegare oppure scollegare i cavi durante un temporale con fulmini.

Advarsel

Utfør aldri arbeid på systemet, eller koble kabler til eller fra systemet når det tordner eller lyner.

Aviso

Não trabalhe no sistema ou ligue e desligue cabos durante períodos de mau tempo (trovoada).

Product Disposal Warning

- ¡Advertencia!** No operar el sistema ni conectar o desconectar cables durante el transcurso de descargas eléctricas en la atmósfera.
- Varning!** Vid åska skall du aldrig utföra arbete på systemet eller ansluta eller koppla loss kablar.
-

警告 雷電時には装置の取り扱い、またはケーブルの接続/切り離しを行わないでください。

Product Disposal Warning



Warning

Ultimate disposal of this product should be handled according to all national laws and regulations.

Waarschuwing

Het uiteindelijke wegruimen van dit product dient te geschieden in overeenstemming met alle nationale wetten en reglementen.

Varoitus

Tämä tuote on hävitettävä kansallisten lakien ja määräysten mukaisesti.

Attention

La mise au rebut ou le recyclage de ce produit sont généralement soumis à des lois et/ou directives de respect de l'environnement. Renseignez-vous auprès de l'organisme compétent.

Warnung

Die Entsorgung dieses Produkts sollte gemäß allen Bestimmungen und Gesetzen des Landes erfolgen.

Avvertenza

Lo smaltimento di questo prodotto deve essere eseguito secondo le leggi e regolazioni locali.

Advarsel

Endelig kassering av dette produktet skal være i henhold til alle relevante nasjonale lover og bestemmelser.

Aviso	Deitar fora este produto em conformidade com todas as leis e regulamentos nacionais.
¡Advertencia!	Al deshacerse por completo de este producto debe seguir todas las leyes y reglamentos nacionales.
Warning!	Vid deponering hanteras produkten enligt gällande lagar och bestämmelser.

Class 1 Laser Product Warning



Warning

Invisible laser radiation may be emitted from the aperture ports of the 100BASE-FX single-mode supervisor engine module. Avoid exposure and do not stare into open apertures.

Waarschuwing: Onzichtbare laserstralen kunnen uit de openingspoorten van de 100BASE-FX enkelkanaals supervisor motormodule komen. Voorkom blootstelling door niet in de open openingen te kijken.

Varoitus Näkymätöntä lasersäteilyä voi levitä 100BASE-FX yksitilaisen ohjainmoottorimoduulin aukoista. Avoimien aukkojen tuijottamista ja säteilylle altistumista tulee välttää.

Avertissement : des radiations laser invisibles peuvent être émises par les ouvertures des ports du moteur de surveillance 100BASE-FX monomode. Ne regardez jamais à travers ces ouvertures et ne restez jamais devant.

Warnung: An den Ausgängen des 100BASE-FX -Single-Mode-Supervisor-Engine-Moduls kann unsichtbare Laserstrahlung emittiert werden. Jeder Kontakt mit der Strahlung und jedes Hineinsehen in die geöffneten Ausgänge ist zu vermeiden.

Laser Beam Exposure Warning

- Avvertenza.** Delle aperture delle porte del modulo apparato supervisore monomodale 100BASE-FX possono essere emesse radiazioni laser invisibili. Evitare l'esposizione diretta e non guardare nelle aperture.
- Advarsel!** Usynlig laserstråling kan emitteres fra aperturutgangene til 100BASE-FX-maskinens styremodul i enkeltmodus. Unngå eksponering, og stirr ikke inn i åpne aperturer.
- Aviso** É possível que haja emissão de uma radiação de laser invisível a partir das portas dos orifícios do módulo do mecanismo supervisor de modo único 100BASE-FX. Evite expor-se a tal radiação e não fixe o seu olhar nos orifícios abertos.
- Aviso:** Los puertos de apertura del módulo de procesador de supervisión de modo único 100BASE-FX pueden emitir radiación láser invisible. Evite exponerse a la misma y no mire directamente a las aperturas.
- Varning!** Osynlig laserstrålning kan eventuellt avges från öppningsportarna på 100BASE-FX enkelt läge övervakarmotormodul. Undvik att utsätta dig för strålning och stirra inte in i öppna hål.
-

Laser Beam Exposure Warning



Warning Avoid exposure to the laser beam.

Waarschuwing Vermijd blootstelling aan de straal.

Varoitus Vältä säteelle altistumista.

Attention Eviter toute exposition au faisceau.

Warnung	Schützen Sie sich vor Strahlung.
Avvertenza	Evitare l'esposizione al raggio.
Advarsel	Unngå å bli utsatt for strålen.
Aviso	Evite exposição ao raio.
¡Advertencia!	Evitar la exposición al haz.
Varning!	Utsätt dig inte för laserstrålningen.

No On/Off Switch Warning



Warning	Unplug the power cord before you work on a system that does not have an on/off switch.
Waarschuwing	Voordat u aan een systeem werkt dat geen aan/uit schakelaar heeft, dient u de stekker van het netsnoer uit het stopcontact te halen.
Varoitus	Ennen kuin teet mitään sellaiselle järjestelmälle, jossa ei ole kaksiasentokytkintä, kytke irti virtajohto.
Attention	Avant de travailler sur un système non équipé d'un commutateur marche-arrêt, débrancher le cordon d'alimentation.
Warnung	Bevor Sie an einem System ohne Ein/Aus-Schalter arbeiten, ziehen Sie das Netzkabel heraus.
Avvertenza	Prima di lavorare su un sistema che non è dotato di un interruttore on/off, scollegare il cavo di alimentazione.

■ No On/Off Switch Warning

Advarsel	Før det skal utføres arbeid på et system som ikke har en av/på-bryter, skal strømledningen trekkes ut.
Aviso	Antes de começar a trabalhar num sistema que não possua um interruptor ON/OFF, desligue o cabo de alimentação.
¡Advertencia!	Antes de trabajar sobre cualquier sistema que carezca de interruptor de Encendido/Apagado (ON/OFF), desenchufar el cable de alimentación.
Varning!	Dra ur nätsladden innan du utför arbete på ett system utan strömbrytare.

警告 オン/オフスイッチのない装置を扱う前には、必ず電源コードを抜いてください。

Chassis Warning—Rack-Mounting and Servicing



Warning

To prevent bodily injury when mounting or servicing this unit in a rack, you must take special precautions to ensure that the system remains stable. The following guidelines are provided to ensure your safety:

- This unit should be mounted at the bottom of the rack if it is the only unit in the rack.
- When mounting this unit in a partially filled rack, load the rack from the bottom to the top with the heaviest component at the bottom of the rack.
- If the rack is provided with stabilizing devices, install the stabilizers before mounting or servicing the unit in the rack.

Waarschuwing

Om lichamelijk letsel te voorkomen wanneer u dit toestel in een rek monteert of het daar een servicebeurt geeft, moet u speciale voorzorgsmaatregelen nemen om ervoor te zorgen dat het toestel stabiel blijft. De onderstaande richtlijnen worden verstrekt om uw veiligheid te verzekeren:

- Dit toestel dient onderaan in het rek gemonteerd te worden als het toestel het enige in het rek is.
- Wanneer u dit toestel in een gedeeltelijk gevuld rek monteert, dient u het rek van onderen naar boven te laden met het zwaarste onderdeel onderaan in het rek.
- Als het rek voorzien is van stabiliseringshulpmiddelen, dient u de stabilisatoren te monteren voordat u het toestel in het rek monteert of het daar een servicebeurt geeft.

- Varoitus** **Kun laite asetetaan telineeseen tai huolletaan sen ollessa telineessä, on noudatettava erityisiä varotoimia järjestelmän vakavuuden säilyttämiseksi, jotta vältetään loukkaantumiselta. Noudata seuraavia turvallisuusohjeita:**
- Jos telineessä ei ole muita laitteita, aseta laite telineen alaosaan.
 - Jos laite asetetaan osaksi täytettyyn telineeseen, aloita kuormittaminen sen alaosasta kaikkein raskaimmalla esineellä ja siirry sitten sen yläosaan.
 - Jos telinettä varten on vakaimet, asenna ne ennen laitteen asettamista telineeseen tai sen huoltamista siinä.
- Attention** **Pour éviter toute blessure corporelle pendant les opérations de montage ou de réparation de cette unité en casier, il convient de prendre des précautions spéciales afin de maintenir la stabilité du système. Les directives ci-dessous sont destinées à assurer la protection du personnel :**
- Si cette unité constitue la seule unité montée en casier, elle doit être placée dans le bas.
 - Si cette unité est montée dans un casier partiellement rempli, charger le casier de bas en haut en plaçant l'élément le plus lourd dans le bas.
 - Si le casier est équipé de dispositifs stabilisateurs, installer les stabilisateurs avant de monter ou de réparer l'unité en casier.

Warnung Zur Vermeidung von Körperverletzung beim Anbringen oder Warten dieser Einheit in einem Gestell müssen Sie besondere Vorkehrungen treffen, um sicherzustellen, daß das System stabil bleibt. Die folgenden Richtlinien sollen zur Gewährleistung Ihrer Sicherheit dienen:

- Wenn diese Einheit die einzige im Gestell ist, sollte sie unten im Gestell angebracht werden.
- Bei Anbringung dieser Einheit in einem zum Teil gefüllten Gestell ist das Gestell von unten nach oben zu laden, wobei das schwerste Bauteil unten im Gestell anzubringen ist.
- Wird das Gestell mit Stabilisierungszubehör geliefert, sind zuerst die Stabilisatoren zu installieren, bevor Sie die Einheit im Gestell anbringen oder sie warten.

Avvertenza Per evitare infortuni fisici durante il montaggio o la manutenzione di questa unità in un supporto, occorre osservare speciali precauzioni per garantire che il sistema rimanga stabile. Le seguenti direttive vengono fornite per garantire la sicurezza personale:

- Questa unità deve venire montata sul fondo del supporto, se si tratta dell'unica unità da montare nel supporto.
- Quando questa unità viene montata in un supporto parzialmente pieno, caricare il supporto dal basso all'alto, con il componente più pesante sistemato sul fondo del supporto.
- Se il supporto è dotato di dispositivi stabilizzanti, installare tali dispositivi prima di montare o di procedere alla manutenzione dell'unità nel supporto.

Advarsel **Unngå fysiske skader under montering eller reparasjonsarbeid på denne enheten når den befinner seg i et kabinett. Vær nøye med at systemet er stabilt. Følgende retningslinjer er gitt for å verne om sikkerheten:**

- Denne enheten bør monteres nederst i kabinettet hvis dette er den eneste enheten i kabinettet.
- Ved montering av denne enheten i et kabinett som er delvis fylt, skal kabinettet lastes fra bunnen og opp med den tyngste komponenten nederst i kabinettet.
- Hvis kabinettet er utstyrt med stabiliseringsutstyr, skal stabilisatorene installeres før montering eller utføring av reparasjonsarbeid på enheten i kabinettet.

Aviso **Para se prevenir contra danos corporais ao montar ou reparar esta unidade numa estante, deverá tomar precauções especiais para se certificar de que o sistema possui um suporte estável. As seguintes diretrizes ajudá-lo-ão a efectuar o seu trabalho com segurança:**

- Esta unidade deverá ser montada na parte inferior da estante, caso seja esta a única unidade a ser montada.
- Ao montar esta unidade numa estante parcialmente ocupada, coloque os itens mais pesados na parte inferior da estante, arrumando-os de baixo para cima.
- Se a estante possuir um dispositivo de estabilização, instale-o antes de montar ou reparar a unidade.

¡Advertencia! Para evitar lesiones durante el montaje de este equipo sobre un bastidor, o posteriormente durante su mantenimiento, se debe poner mucho cuidado en que el sistema quede bien estable. Para garantizar su seguridad, proceda según las siguientes instrucciones:

- Colocar el equipo en la parte inferior del bastidor, cuando sea la única unidad en el mismo.
- Cuando este equipo se vaya a instalar en un bastidor parcialmente ocupado, comenzar la instalación desde la parte inferior hacia la superior colocando el equipo más pesado en la parte inferior.
- Si el bastidor dispone de dispositivos estabilizadores, instalar éstos antes de montar o proceder al mantenimiento del equipo instalado en el bastidor.

Varning! För att undvika kroppsskada när du installerar eller utför underhållsarbete på denna enhet på en ställning måste du vidta särskilda försiktighetsåtgärder för att försäkra dig om att systemet står stadigt. Följande riktlinjer ges för att trygga din säkerhet:

- Om denna enhet är den enda enheten på ställningen skall den installeras längst ned på ställningen.
- Om denna enhet installeras på en delvis fylld ställning skall ställningen fyllas nedifrån och upp, med de tyngsta enheterna längst ned på ställningen.
- Om ställningen är försedd med stabiliseringsdon skall dessa monteras fast innan enheten installeras eller underhålls på ställningen.

■ Chassis Warning—Rack-Mounting and Servicing

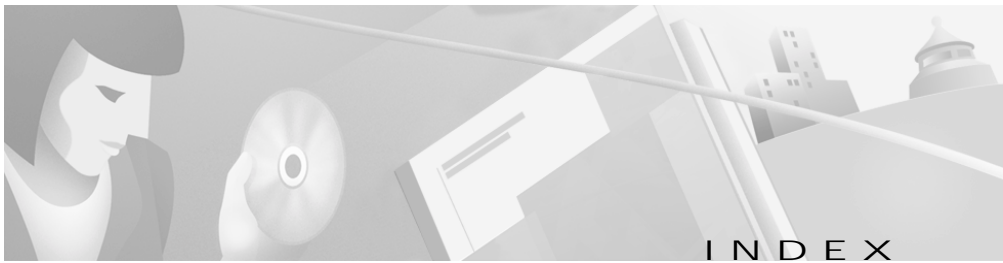

Numerics

10/100BASE-T ports

- cables and connectors [B-1](#)
- connecting to [2-26](#)
- connection distances, maximum [1-6](#)
- full duplex [1-6, 1-7](#)
- half duplex [1-6](#)
- pinouts [B-2](#)

100BASE-FX ports

- cables and connectors [B-2](#)
- connecting to [2-28 to 2-30](#)
- connection distances, maximum [1-7](#)

100 port mode LED [1-13 to 1-15](#)

19-, 23-, and 24-inch racks [2-8](#)

A

AC power

- connecting to [2-25](#)
- connector [1-19](#)
- warning [C-2 to C-5](#)

adapter pinouts

- See terminal adapter pinouts

autonegotiation [1-6](#)

B

baud rate [2-33](#)

brackets

- See mounting brackets

C

cables

- 10/100BASE-T ports [B-1 to B-2, B-4](#)
- 100BASE-FX, 50/125- or 62.5/125-micron fiber-optic [2-28, B-2](#)
- crossover and straight-through pinouts [B-4](#)
- RJ-21 pinouts [B-5](#)
- rollover [B-6](#)
- rollover pinouts
 - DB-25 adapter [B-8](#)

CCO

- See Cisco.com

chassis, warning against stacking [C-8](#)

circuit breaker (15A) warning [C-15](#)

Cisco.com [xix](#)

Cisco Cluster Management Suite [1-4](#)

Cisco RPS

- See RPS

- CiscoWorks 2000 [1-4](#)
 - Class 1 laser product warning [C-25](#)
 - Cluster Management Suite [1-4](#)
 - command-line interface (CLI) [1-4](#)
 - connecting 10/100 ports to IP Phones [2-27](#)
 - connecting to
 - 10/100BASE-T ports [2-26](#)
 - 100BASE-FX ports [2-28 to 2-30](#)
 - console port [2-33 to 2-34](#)
 - LRE port [2-30 to 2-32](#)
 - workstation [B-7](#)
 - connection distances, maximum
 - 10/100BASE-T ports [1-6](#)
 - 100BASE-FX ports [1-7](#)
 - LRE ports [2-6](#)
 - connectivity problems, solving [3-3](#)
 - connectors
 - RJ-21 [B-3, B-5](#)
 - connectors, See also ports
 - console [B-5](#)
 - connectors and cables [1-19](#)
 - 10/100BASE-T ports [B-1 to B-2](#)
 - 100BASE-FX ports [1-7, B-2](#)
 - console port [2-33 to 2-34](#)
 - power (AC and RPS) [1-19](#)
 - RJ-21 connector [B-3, B-5](#)
 - RPS 300 [1-20](#)
 - RPS 600 [1-20](#)
 - See also ports
 - console port [1-21](#)
 - adapter pinouts
 - RJ-45-to-DB-25 terminal [B-7](#)
 - RJ-45-to-DB-9 terminal [B-6](#)
 - cable [B-6](#)
 - connecting to [2-33 to 2-34](#)
 - default characteristics [2-33](#)
 - conventions, document [xii](#)
 - crossover cable
 - connectivity problems [3-5](#)
 - pinout [B-4](#)
-
- ## D
- default characteristics of the console port [2-33](#)
 - documentation, CD-ROM
 - Catalyst 2900 XL and Catalyst 3500 XL [xvi](#)
 - document conventions [xii](#)
 - duplex SC connector [B-2](#)
-
- ## E
- expansion slots
 - illustration [1-5](#)
 - LEDs [1-17](#)
 - overview [1-8](#)
 - supported modules [1-8](#)

F

feedback to Cisco Systems, web [xviii](#)

fiber-optic cable

50/125- or 62.5/125-micron [2-28, B-2](#)

front panel

10/100 ports [1-6](#)

expansion slots [1-8](#)

fixed ports [1-6](#)

LEDs [1-9](#)

LRE ports [1-7](#)

full duplex

10/100BASE-T ports [1-6, 1-7](#)

LED [1-15, 1-16](#)

port mode [1-15, 1-16](#)

G

ground connection warning [C-14](#)

grounded equipment warning [C-17](#)

H

half duplex

10/100BASE-T ports [1-6](#)

LED [1-15, 1-16](#)

port mode [1-15, 1-16](#)

hot-swappable modules [1-8](#)

HP OpenView [1-4](#)

I

installation

attaching mounting brackets
(rack-mount) [2-11, 2-17](#)

attaching mounting brackets (telco
rack-mount) [2-16](#)

attaching mounting brackets
(wall-mount) [2-23](#)

cable guide [2-20](#)

connecting to

10/100BASE-T ports [2-26](#)

100BASE-FX ports [2-28 to 2-30](#)

console port [2-33 to 2-34](#)

LRE port [2-30 to 2-32](#)

console port

connecting to [2-33 to 2-34](#)

electrical noise, avoiding [2-6](#)

guidelines [2-5](#)

mounting in a rack [2-19 to 2-20](#)

mounting on a wall [2-23 to 2-25](#)

packing list [2-6](#)

rack-mount [2-19 to 2-20](#)

table or shelf [2-7](#)

wall-mount [2-23 to 2-25](#)

warnings [2-1 to 2-4](#)

IOS command-line interface [1-4](#)

IP Phones

connecting to 10/100 ports [2-27](#)

J

jewelry removal warning [C-6](#)

L

LAN-to-phone jack [2-27](#)

Laser beam exposure warning [C-26](#)

LEDs

100 port mode [1-13, 1-15](#)

DUPLX [1-16](#)

expansion slots [1-17](#)

FDUP [1-13, 1-15](#)

full duplex [1-15, 1-16](#)

half duplex [1-15, 1-16](#)

interpreting [1-13](#)

LRE [1-14, 1-16](#)

port status [1-9, 1-15 to 1-16](#)

POST results [2-25, 3-2](#)

RPS [1-12 to 1-13](#)

RPS 300 [1-13](#)

RPS 600 [1-12](#)

SPEED [1-14, 1-16](#)

STAT [1-13 to 1-16](#)

STAT LED [1-15](#)

System [1-11](#)

UTL [1-13, 1-15](#)

lightning activity warning [C-23](#)

long-reach Ethernet

See LRE

LRE

defined [1-1](#)

LED [1-14, 1-16](#)

port

connecting to [2-30 to 2-32](#)

See also RJ-21 connector

M

main disconnecting device warning [C-9](#)

maximum connection distances

See connection distances, maximum

mid-mount

See installation

attaching mounting brackets (telco rack-mount)

modules [1-8](#)

mounting brackets [2-8](#)

attaching [2-11, 2-16, 2-17, 2-23](#)

N

no on/off switch warning [C-27](#)

O

overtemperature warning [C-10](#)

P

packing list [2-6](#)

PC, connecting to switch [2-33](#)

performance problems, solving [3-3](#)

personnel warning [C-4](#)

pinouts

10/100BASE-T ports [B-2](#)

cable, straight-through and crossover [B-4](#)

RJ-21 connector [B-5](#)

RJ-45-to-DB-25 terminal adapter [B-8](#)

RJ-45-to-DB-9 terminal adapter [B-7](#)

rollover cable [B-7, B-8](#)

ports

10/100BASE-T [1-6](#)

100BASE-FX [1-7](#)

console [1-21](#)

console connector pinouts [B-5](#)

LRE [1-7](#)

module [1-8](#)

port status LEDs [1-9, 1-15 to 1-16](#)

port status LEDs [1-9, 1-15 to 1-16](#)

POST results [2-25](#)

power

connecting to [2-25](#)

warning [C-18](#)

power connectors [1-19](#)

power on [2-25](#)

power supply

AC power outlet [1-19](#)

RPS connector [1-19](#)

warning [C-21](#)

product disposal warning [C-24](#)

Q

qualified personnel warning [C-4](#)

R

rack installation

bracket mounting points [2-9](#)

rear panel

AC power connector [1-19](#)

console port [B-5](#)

RPS connector [1-19](#)

RJ-21 connector

illustration [1-7](#)

pinouts [B-5](#)

RJ-45 connector, console port [2-34, B-3, B-5](#)

RJ-45 console port [1-18](#)

rollover cable [2-34, B-6](#)

identifying [B-6](#)

pinouts [B-8](#)

RPS

LED [1-12 to 1-13](#)

RPS 300

connector [1-20](#)

LED [1-13](#)

supported switches [1-19](#)

warning [C-3](#)

RPS 600

connector [1-20](#)

LED [1-12](#)

supported switches [1-19](#)

warning [C-2](#)

S

safety [C-1](#)

SC connectors [B-2](#)

SPEED LED [1-14, 1-16](#)

stacking the chassis warning [C-8](#)

STAT LED [1-13 to 1-16](#)

straight-through cable pinouts

cables

straight-through [B-4](#)

SunNet Manager [1-4](#)

supply circuit warning [C-18](#)

switch

powering on [2-25](#)

switched ports, module [1-8](#)

System LED [1-11](#)

T

Telco [2-16](#)

telephone network power warning

See TN power warning [C-13](#)

Telnet, and accessing the CLI [1-4](#)

temperature

maximum for installation [2-6, A-2](#)

warning [C-10](#)

temperature warning [C-10](#)

terminal, connecting to switch [2-33](#)

terminal adapter pinouts

RH-45-to-RJ-45 [B-7](#)

RJ-45-to-DB-25 [B-7](#)

RJ-45-to-DB-9 [B-6](#)

terminal emulation software [2-33](#)

TN power warning [C-13](#)

translated warnings [C-1 to C-33](#)

U

UTL LED [1-13, 1-15](#)

V

VDSL

defined [1-1](#)

very-high-data-rate digital subscriber line

See VDSL

voltage warning [C-19](#)

W

warnings

translated [C-1 to C-33](#)

