

You'll be entered into a quarterly drawing for **free** Cisco Press books by returning this survey! Cisco is dedicated to customer satisfaction and would like to hear your thoughts on these printed manuals. Please visit the Cisco Product Comments on-line survey at www.cisco.com/go/crc to submit your comments about accessing Cisco technical manuals. Thank you for your time

General Information

- 1 Years of networking experience: _____ Years of experience with Cisco products: _____
- 2 I have these network types: _____ LAN _____ Backbone _____ WAN
_____ Other: _____
- 3 I have these Cisco products: _____ Switches _____ Routers
_____ Other (specify models): _____
- 4 I perform these types of tasks: _____ H/W installation and/or maintenance _____ S/W configuration
_____ Network management _____ Other: _____
- 5 I use these types of documentation: _____ H/W installation _____ H/W configuration _____ S/W configuration
_____ Command reference _____ Quick reference _____ Release notes _____ Online help
_____ Other: _____
- 6 I access this information through: _____ % Cisco.com _____ % CD-ROM _____ % Printed manuals
_____ % Other: _____
- 7 I prefer this access method: _____ Cisco.com _____ CD-ROM _____ Printed manuals
_____ Other: _____
- 8 I use the following three product features the most: _____

Document Information

Document Title: Cisco ONS 15540 ESP Planning Guide

Part Number: 78-16020-03 S/W Release (if applicable): _____

- On a scale of 1-5 (5 being the best), please let us know how we rate in the following areas:
- _____ The document is complete. _____ The information is accurate.
_____ The information is well organized. _____ The information I wanted was easy to find.
_____ The document is written at my _____ The information I found was useful to my job.
_____ technical level of understanding.

Please comment on our lowest scores: _____

Mailing Information

Organization _____ Date _____

Contact Name _____

Mailing Address _____

City _____ State/Province _____ Zip/Postal Code _____

Country _____ Phone () _____ Extension _____

E-mail _____ Fax () _____

May we contact you further concerning our documentation? _____ Yes _____ No

You can also send us your comments by e-mail to bug-doc@cisco.com, or by fax to **408-527-8089**.

When mailing this card from outside of the United States, please enclose in an envelope addressed to the location on the back of this card with the required postage or fax to 1-408-527-8089.

BUSINESS REPLY MAIL

FIRST-CLASS MAIL PERMIT NO. 4631 SAN JOSE CA

POSTAGE WILL BE PAID BY ADDRESSEE

DOCUMENT RESOURCE CONNECTION
CISCO SYSTEMS INC
170 WEST TASMAN DR
SAN JOSE CA 95134-9916



NO POSTAGE
NECESSARY
IF MAILED
IN THE
UNITED STATES

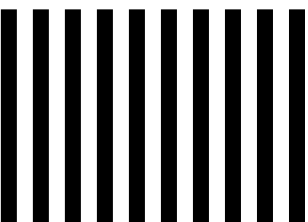



Cisco ONS 15540 ESP Planning Guide

Corporate Headquarters
Cisco Systems, Inc.
170 West Tasman Drive
San Jose, CA 95134-1706
USA
<http://www.cisco.com>
Tel: 408 526-4000
800 553-NETS (6387)
Fax: 408 526-4100

Customer Order Number: DOC-7816020=
Text Part Number: 78-16020-03



THE SPECIFICATIONS AND INFORMATION REGARDING THE PRODUCTS IN THIS MANUAL ARE SUBJECT TO CHANGE WITHOUT NOTICE. ALL STATEMENTS, INFORMATION, AND RECOMMENDATIONS IN THIS MANUAL ARE BELIEVED TO BE ACCURATE BUT ARE PRESENTED WITHOUT WARRANTY OF ANY KIND, EXPRESS OR IMPLIED. USERS MUST TAKE FULL RESPONSIBILITY FOR THEIR APPLICATION OF ANY PRODUCTS.

THE SOFTWARE LICENSE AND LIMITED WARRANTY FOR THE ACCOMPANYING PRODUCT ARE SET FORTH IN THE INFORMATION PACKET THAT SHIPPED WITH THE PRODUCT AND ARE INCORPORATED HEREIN BY THIS REFERENCE. IF YOU ARE UNABLE TO LOCATE THE SOFTWARE LICENSE OR LIMITED WARRANTY, CONTACT YOUR CISCO REPRESENTATIVE FOR A COPY.

The following information is for FCC compliance of Class A devices: This equipment has been tested and found to comply with the limits for a Class A digital device, pursuant to part 15 of the FCC rules. These limits are designed to provide reasonable protection against harmful interference when the equipment is operated in a commercial environment. This equipment generates, uses, and can radiate radio-frequency energy and, if not installed and used in accordance with the instruction manual, may cause harmful interference to radio communications. Operation of this equipment in a residential area is likely to cause harmful interference, in which case users will be required to correct the interference at their own expense.

The following information is for FCC compliance of Class B devices: The equipment described in this manual generates and may radiate radio-frequency energy. If it is not installed in accordance with Cisco's installation instructions, it may cause interference with radio and television reception. This equipment has been tested and found to comply with the limits for a Class B digital device in accordance with the specifications in part 15 of the FCC rules. These specifications are designed to provide reasonable protection against such interference in a residential installation. However, there is no guarantee that interference will not occur in a particular installation.

Modifying the equipment without Cisco's written authorization may result in the equipment no longer complying with FCC requirements for Class A or Class B digital devices. In that event, your right to use the equipment may be limited by FCC regulations, and you may be required to correct any interference to radio or television communications at your own expense.

You can determine whether your equipment is causing interference by turning it off. If the interference stops, it was probably caused by the Cisco equipment or one of its peripheral devices. If the equipment causes interference to radio or television reception, try to correct the interference by using one or more of the following measures:

- Turn the television or radio antenna until the interference stops.
- Move the equipment to one side or the other of the television or radio.
- Move the equipment farther away from the television or radio.
- Plug the equipment into an outlet that is on a different circuit from the television or radio. (That is, make certain the equipment and the television or radio are on circuits controlled by different circuit breakers or fuses.)

Modifications to this product not authorized by Cisco Systems, Inc. could void the FCC approval and negate your authority to operate the product.

The Cisco implementation of TCP header compression is an adaptation of a program developed by the University of California, Berkeley (UCB) as part of UCB's public domain version of the UNIX operating system. All rights reserved. Copyright © 1981, Regents of the University of California.

NOTWITHSTANDING ANY OTHER WARRANTY HEREIN, ALL DOCUMENT FILES AND SOFTWARE OF THESE SUPPLIERS ARE PROVIDED "AS IS" WITH ALL FAULTS. CISCO AND THE ABOVE-NAMED SUPPLIERS DISCLAIM ALL WARRANTIES, EXPRESSED OR IMPLIED, INCLUDING, WITHOUT LIMITATION, THOSE OF MERCHANTABILITY, FITNESS FOR A PARTICULAR PURPOSE AND NONINFRINGEMENT OR ARISING FROM A COURSE OF DEALING, USAGE, OR TRADE PRACTICE.

IN NO EVENT SHALL CISCO OR ITS SUPPLIERS BE LIABLE FOR ANY INDIRECT, SPECIAL, CONSEQUENTIAL, OR INCIDENTAL DAMAGES, INCLUDING, WITHOUT LIMITATION, LOST PROFITS OR LOSS OR DAMAGE TO DATA ARISING OUT OF THE USE OR INABILITY TO USE THIS MANUAL, EVEN IF CISCO OR ITS SUPPLIERS HAVE BEEN ADVISED OF THE POSSIBILITY OF SUCH DAMAGES.

CCSP, CCVP, the Cisco Square Bridge logo, Follow Me Browsing, and StackWise are trademarks of Cisco Systems, Inc.; Changing the Way We Work, Live, Play, and Learn, and iQuick Study are service marks of Cisco Systems, Inc.; and Access Registrar, Aironet, ASIST, BPX, Catalyst, CCDA, CCDP, CCIE, CCIP, CCNA, CCNP, Cisco, the Cisco Certified Internetwork Expert logo, Cisco IOS, Cisco Press, Cisco Systems, Cisco Systems Capital, the Cisco Systems logo, Cisco Unity, Empowering the Internet Generation, Enterprise/Solver, EtherChannel, EtherFast, EtherSwitch, Fast Step, FormShare, GigaDrive, GigaStack, HomeLink, Internet Quotient, IOS, IP/TV, iQ Expertise, the iQ logo, iQ Net Readiness Scorecard, LightStream, Linksys, MeetingPlace, MGX, the Networkers logo, Networking Academy, Network Registrar, *Packet*, PIX, Post-Routing, Pre-Routing, ProConnect, RateMUX, ScriptShare, SlideCast, SMARTnet, StrataView Plus, TeleRouter, The Fastest Way to Increase Your Internet Quotient, and TransPath are registered trademarks of Cisco Systems, Inc. and/or its affiliates in the United States and certain other countries.

All other trademarks mentioned in this document or Website are the property of their respective owners. The use of the word partner does not imply a partnership relationship between Cisco and any other company. (0502R)

Cisco ONS 15540 ESP Planning Guide

Copyright © 2005 Cisco Systems, Inc. All rights reserved.



Preface	vii
Purpose	vii
Audience	vii
Organization	viii
Related Documentation	viii
Obtaining Documentation	ix
Cisco.com	ix
Documentation DVD	ix
Ordering Documentation	ix
Documentation Feedback	x
Cisco Product Security Overview	x
Reporting Security Problems in Cisco Products	x
Obtaining Technical Assistance	xi
Cisco Technical Support Website	xi
Submitting a Service Request	xi
Definitions of Service Request Severity	xii
Obtaining Additional Publications and Information	xii

CHAPTER 1

System Overview	1-1
Chassis Description	1-1
System Functional Overview	1-2
System Components	1-3
Transponder Modules	1-3
SM Transponder Modules and MM Transponder Modules	1-4
Type 2 Extended Range Transponder Modules with SFP Optics	1-7
Conditions Monitored on 2.5-Gbps Transponder Modules	1-10
2.5-Gbps Line Card Motherboards	1-11
Mux/Demux Motherboards	1-11
OSC	1-11
Optical Mux/Demux Modules	1-12
Optical Mux/Demux Modules and Channel Bands	1-12
Add/Drop Mux/Demux Modules	1-12
Terminal Mux/Demux Modules	1-13
Optical Mux/Demux Module Configurations	1-13

- Processors Cards 1-15
 - Processor Redundancy and Online Insertion and Removal 1-16
- Security Features 1-16
- System and Network Management 1-16
 - NME 1-17
 - Comparison of the OSC and SONET 1-17

CHAPTER 2

- Protection Schemes and Network Topologies 2-1**
 - Protection Against Fiber and System Failures 2-1
 - Splitter Based Facility Protection 2-1
 - Optical Backplane 2-3
 - Y-Cable Based Line Card Protection 2-4
 - Client Based Line Card Protection 2-6
 - Supported Topologies 2-6
 - Linear Topologies 2-7
 - Unprotected Point-to-Point Topology 2-7
 - Protected Point-to-Point Topology 2-7
 - Bus Topology 2-8
 - Ring Topologies 2-9
 - Hubbed Ring 2-9
 - Meshed Ring 2-10
 - Protection in Ring Topologies 2-10

CHAPTER 3

- Shelf Configuration Rules 3-1**
 - Per Shelf Rules Using Add/Drop Mux/Demux Modules 3-1
 - Add/Drop Mux/Demux Modules with Splitter Protection 3-2
 - Add/Drop Mux/Demux Modules Without Splitter Protection 3-3
 - 4-Channel Mux/Demux Modules Without Splitter Protection 3-3
 - 8-Channel Mux/Demux Modules Without Splitter Protection 3-4
 - Transponder Module Placement When Using Add/Drop Mux/Demux Modules 3-5
 - Transponder Modules with 4-Channel Mux/Demux Modules 3-5
 - Transponder Modules with 8-Channel Mux/Demux Modules 3-8
 - Cabling of Add/Drop Mux/Demux Modules 3-9
 - Per Shelf Rules Using Terminal Mux/Demux Modules 3-10
 - Terminal Mux/Demux Modules with Splitter Protection 3-10
 - Terminal Mux/Demux Modules Without Splitter Protection 3-10
 - Transponder Module Placement When Using Terminal Mux/Demux Modules 3-10
 - Cabling of Terminal Mux/Demux Modules 3-12
 - Per Shelf Rules for 2.5-Gbps Line Card Motherboards 3-12

General Rules for Ring Topologies 3-13

CHAPTER 4

Optical Loss Budgets	4-1
About dB and dBm	4-1
Overall Optical Loss Budget	4-2
Calculating Optical Loss Budgets	4-3
Optical Loss for 2.5-Gbps Line Card Motherboards	4-4
Optical Loss for Optical Mux/Demux Modules	4-4
Loss for Data Channels	4-4
Loss for the OSC	4-5
Fiber Plant Testing	4-5
Link Loss (Attenuation)	4-6
ORL	4-6
PMD	4-6
Chromatic Dispersion	4-7

CHAPTER 5

Example Topologies and Shelf Configurations	5-1
Point-to-Point Topologies	5-1
Unprotected 32-Channel Point-to-Point Configuration	5-2
Splitter Protected 32-Channel Point-to-Point Configuration	5-4
Line Card Protected 16-Channel Point-to-Point Configuration	5-6
Line Card Protected 32-Channel Point-to-Point Configuration	5-8
Hubbed Ring Topologies	5-11
Splitter Protected Hubbed Ring Configuration	5-11
Line Card Protected Hubbed Ring Configuration	5-22
Meshed Ring Topologies	5-33
Splitter Protected Meshed Ring Configuration	5-35
Line Card Protected Meshed Ring Configuration	5-44
Meshed Ring Topologies with Unprotected Channels	5-52
Splitter Protected Meshed Ring with Unprotected Channels Configuration	5-53
Line Card Protected Meshed Ring with Unprotected Channels Configuration	5-58

APPENDIX A

IBM Storage Protocol Support	A-1
IBM Storage Environment	A-1
Supported Protocols	A-2
Client Optical Power Budget and Attenuation Requirements	A-4

INDEX



Preface

This preface describes the purpose, intended audience, organization, and conventions for the *Cisco ONS 15540 ESP Planning Guide*.

Purpose

This guide serves as a planning tool for implementing DWDM transport networks using the Cisco ONS 15540 ESP (Extended Services Platform). This guide addresses important considerations and provides guidelines for planning an optical network. These include an understanding of the Cisco ONS 15540 ESP basic system design, supported topologies and protection schemes, engineering rules and restrictions, and optical power budget calculations. Typical example networks are described, along with their associated chassis configurations.

Audience

This guide is intended for system designers, engineers, and others responsible for designing networks based on DWDM transport using the Cisco ONS 15540 ESP.



Note

The planning guidelines in this document are based on the best currently available knowledge about the functionality and operation of the Cisco ONS 15540 ESP. The information in this document is subject to change without notice.

Organization

The chapters of this guide are as follows:

Chapter	Title	Description
Chapter 1	System Overview	Describes the Cisco ONS 15540 ESP chassis, components, and system architecture
Chapter 2	Protection Schemes and Network Topologies	Describes the supported network topologies and fault protection schemes
Chapter 3	Shelf Configuration Rules	Provides the rules for physical configuration of the Cisco ONS 15540 ESP
Chapter 4	Optical Loss Budgets	Provides metrics for calculating optical link loss budgets in Cisco ONS 15540 ESP based networks
Chapter 5	Example Topologies and Shelf Configurations	Provides examples of common topologies and protection options with configurations
Appendix A	IBM Storage Protocol Support	Provides design information for applications that use IBM storage protocols

Related Documentation

This guide is part of a documentation set that supports the Cisco ONS 15540 ESP. The other documents in the set are as follows:

- [Regulatory Compliance and Safety Information for the Cisco ONS 15500 Series](#)
- [Cisco ONS 15540 ESP Hardware Installation Guide](#)
- [Cisco ONS 15540 ESP Optical Transport Turn-Up and Test Guide](#)
- [Cisco ONS 15540 ESP Configuration Guide](#)
- [Cisco ONS 15540 ESP Command Reference](#)
- [Cisco ONS 15540 ESP TLI Command Reference](#)
- [Cisco ONS 15540 ESP System Alarms and Error Messages](#)
- [Cisco ONS 15540 ESP Troubleshooting Guide](#)
- [Network Management for the Cisco ONS 15540 ESP](#)
- [MIB Quick Reference for the Cisco ONS 15500](#)

Obtaining Documentation

Cisco documentation and additional literature are available on Cisco.com. Cisco also provides several ways to obtain technical assistance and other technical resources. These sections explain how to obtain technical information from Cisco Systems.

Cisco.com

You can access the most current Cisco documentation at this URL:

<http://www.cisco.com/univercd/home/home.htm>

You can access the Cisco website at this URL:

<http://www.cisco.com>

You can access international Cisco websites at this URL:

http://www.cisco.com/public/countries_languages.shtml

Documentation DVD

Cisco documentation and additional literature are available in a Documentation DVD package, which may have shipped with your product. The Documentation DVD is updated regularly and may be more current than printed documentation. The Documentation DVD package is available as a single unit.

Registered Cisco.com users (Cisco direct customers) can order a Cisco Documentation DVD (product number DOC-DOCDVD=) from the Ordering tool or Cisco Marketplace.

Cisco Ordering tool:

<http://www.cisco.com/en/US/partner/ordering/>

Cisco Marketplace:

<http://www.cisco.com/go/marketplace/>

Ordering Documentation

You can find instructions for ordering documentation at this URL:

http://www.cisco.com/univercd/cc/td/doc/es_inpk/pdi.htm

You can order Cisco documentation in these ways:

- Registered Cisco.com users (Cisco direct customers) can order Cisco product documentation from the Ordering tool:
<http://www.cisco.com/en/US/partner/ordering/>
- Nonregistered Cisco.com users can order documentation through a local account representative by calling Cisco Systems Corporate Headquarters (California, USA) at 408 526-7208 or, elsewhere in North America, by calling 1 800 553-NETS (6387).

Documentation Feedback

You can send comments about technical documentation to bug-doc@cisco.com.

You can submit comments by using the response card (if present) behind the front cover of your document or by writing to the following address:

Cisco Systems
Attn: Customer Document Ordering
170 West Tasman Drive
San Jose, CA 95134-9883

We appreciate your comments.

Cisco Product Security Overview

Cisco provides a free online Security Vulnerability Policy portal at this URL:

http://www.cisco.com/en/US/products/products_security_vulnerability_policy.html

From this site, you can perform these tasks:

- Report security vulnerabilities in Cisco products.
- Obtain assistance with security incidents that involve Cisco products.
- Register to receive security information from Cisco.

A current list of security advisories and notices for Cisco products is available at this URL:

<http://www.cisco.com/go/psirt>

If you prefer to see advisories and notices as they are updated in real time, you can access a Product Security Incident Response Team Really Simple Syndication (PSIRT RSS) feed from this URL:

http://www.cisco.com/en/US/products/products_psirt_rss_feed.html

Reporting Security Problems in Cisco Products

Cisco is committed to delivering secure products. We test our products internally before we release them, and we strive to correct all vulnerabilities quickly. If you think that you might have identified a vulnerability in a Cisco product, contact PSIRT:

- Emergencies—security-alert@cisco.com
- Nonemergencies—psirt@cisco.com



Tip

We encourage you to use Pretty Good Privacy (PGP) or a compatible product to encrypt any sensitive information that you send to Cisco. PSIRT can work from encrypted information that is compatible with PGP versions 2.x through 8.x.

Never use a revoked or an expired encryption key. The correct public key to use in your correspondence with PSIRT is the one that has the most recent creation date in this public key server list:

<http://pgp.mit.edu:11371/pks/lookup?search=psirt%40cisco.com&op=index&exact=on>

In an emergency, you can also reach PSIRT by telephone:

- 1 877 228-7302
- 1 408 525-6532

Obtaining Technical Assistance

For all customers, partners, resellers, and distributors who hold valid Cisco service contracts, Cisco Technical Support provides 24-hour-a-day, award-winning technical assistance. The Cisco Technical Support Website on Cisco.com features extensive online support resources. In addition, Cisco Technical Assistance Center (TAC) engineers provide telephone support. If you do not hold a valid Cisco service contract, contact your reseller.

Cisco Technical Support Website

The Cisco Technical Support Website provides online documents and tools for troubleshooting and resolving technical issues with Cisco products and technologies. The website is available 24 hours a day, 365 days a year, at this URL:

<http://www.cisco.com/techsupport>

Access to all tools on the Cisco Technical Support Website requires a Cisco.com user ID and password. If you have a valid service contract but do not have a user ID or password, you can register at this URL:

<http://tools.cisco.com/RPF/register/register.do>



Note

Use the Cisco Product Identification (CPI) tool to locate your product serial number before submitting a web or phone request for service. You can access the CPI tool from the Cisco Technical Support Website by clicking the **Tools & Resources** link under Documentation & Tools. Choose **Cisco Product Identification Tool** from the Alphabetical Index drop-down list, or click the **Cisco Product Identification Tool** link under Alerts & RMAs. The CPI tool offers three search options: by product ID or model name; by tree view; or for certain products, by copying and pasting **show** command output. Search results show an illustration of your product with the serial number label location highlighted. Locate the serial number label on your product and record the information before placing a service call.

Submitting a Service Request

Using the online TAC Service Request Tool is the fastest way to open S3 and S4 service requests. (S3 and S4 service requests are those in which your network is minimally impaired or for which you require product information.) After you describe your situation, the TAC Service Request Tool provides recommended solutions. If your issue is not resolved using the recommended resources, your service request is assigned to a Cisco TAC engineer. The TAC Service Request Tool is located at this URL:

<http://www.cisco.com/techsupport/servicerequest>

For S1 or S2 service requests or if you do not have Internet access, contact the Cisco TAC by telephone. (S1 or S2 service requests are those in which your production network is down or severely degraded.) Cisco TAC engineers are assigned immediately to S1 and S2 service requests to help keep your business operations running smoothly.

To open a service request by telephone, use one of the following numbers:

Asia-Pacific: +61 2 8446 7411 (Australia: 1 800 805 227)

EMEA: +32 2 704 55 55

USA: 1 800 553-2447

For a complete list of Cisco TAC contacts, go to this URL:

<http://www.cisco.com/techsupport/contacts>

Definitions of Service Request Severity

To ensure that all service requests are reported in a standard format, Cisco has established severity definitions.

Severity 1 (S1)—Your network is “down,” or there is a critical impact to your business operations. You and Cisco will commit all necessary resources around the clock to resolve the situation.

Severity 2 (S2)—Operation of an existing network is severely degraded, or significant aspects of your business operation are negatively affected by inadequate performance of Cisco products. You and Cisco will commit full-time resources during normal business hours to resolve the situation.

Severity 3 (S3)—Operational performance of your network is impaired, but most business operations remain functional. You and Cisco will commit resources during normal business hours to restore service to satisfactory levels.

Severity 4 (S4)—You require information or assistance with Cisco product capabilities, installation, or configuration. There is little or no effect on your business operations.

Obtaining Additional Publications and Information

Information about Cisco products, technologies, and network solutions is available from various online and printed sources.

- Cisco Marketplace provides a variety of Cisco books, reference guides, and logo merchandise. Visit Cisco Marketplace, the company store, at this URL:

<http://www.cisco.com/go/marketplace/>

- *Cisco Press* publishes a wide range of general networking, training and certification titles. Both new and experienced users will benefit from these publications. For current Cisco Press titles and other information, go to Cisco Press at this URL:

<http://www.ciscopress.com>

- *Packet* magazine is the Cisco Systems technical user magazine for maximizing Internet and networking investments. Each quarter, Packet delivers coverage of the latest industry trends, technology breakthroughs, and Cisco products and solutions, as well as network deployment and troubleshooting tips, configuration examples, customer case studies, certification and training information, and links to scores of in-depth online resources. You can access Packet magazine at this URL:

<http://www.cisco.com/packet>

- *iQ Magazine* is the quarterly publication from Cisco Systems designed to help growing companies learn how they can use technology to increase revenue, streamline their business, and expand services. The publication identifies the challenges facing these companies and the technologies to help solve them, using real-world case studies and business strategies to help readers make sound technology investment decisions. You can access iQ Magazine at this URL:

<http://www.cisco.com/go/iqmagazine>

- *Internet Protocol Journal* is a quarterly journal published by Cisco Systems for engineering professionals involved in designing, developing, and operating public and private internets and intranets. You can access the Internet Protocol Journal at this URL:

<http://www.cisco.com/ipj>

- World-class networking training is available from Cisco. You can view current offerings at this URL:

<http://www.cisco.com/en/US/learning/index.html>



System Overview

The Cisco ONS 15540 ESP is an optical transport platform that employs DWDM (dense wavelength division multiplexing) technology. With the Cisco ONS 15540 ESP, users can take advantage of the availability of dark fiber to build a common infrastructure that supports data networking (Ethernet based as well as SONET/SDH based) and storage networking.

This chapter contains the following major sections:

- [Chassis Description, page 1-1](#)
- [System Functional Overview, page 1-2](#)
- [System Components, page 1-3](#)
- [Security Features, page 1-16](#)
- [System and Network Management, page 1-16](#)

Chassis Description

The Cisco ONS 15540 ESP uses a 12-slot modular vertical chassis (see [Figure 1-1](#)). The system receives power through redundant -48 VDC inputs. A redundant external AC power supply is available, or DC power can be provided directly. As you face the chassis, the two leftmost slots (slots 0–1) hold the mux/demux motherboards. These slots, which are populated with optical mux/demux modules, correspond to the west and east directions, respectively. Slots 2–5 and 8–11 hold the line card motherboards, which are populated with transponder modules. Slots 6–7 hold the processor cards. Air inlet, fan tray, and cable management are located beneath the modular slots. The system has an optical backplane for carrying signals between the transponder modules and the optical mux/demux modules and an electrical backplane for system control.

Figure 1-1 Cisco ONS 15540 ESP Shelf Layout

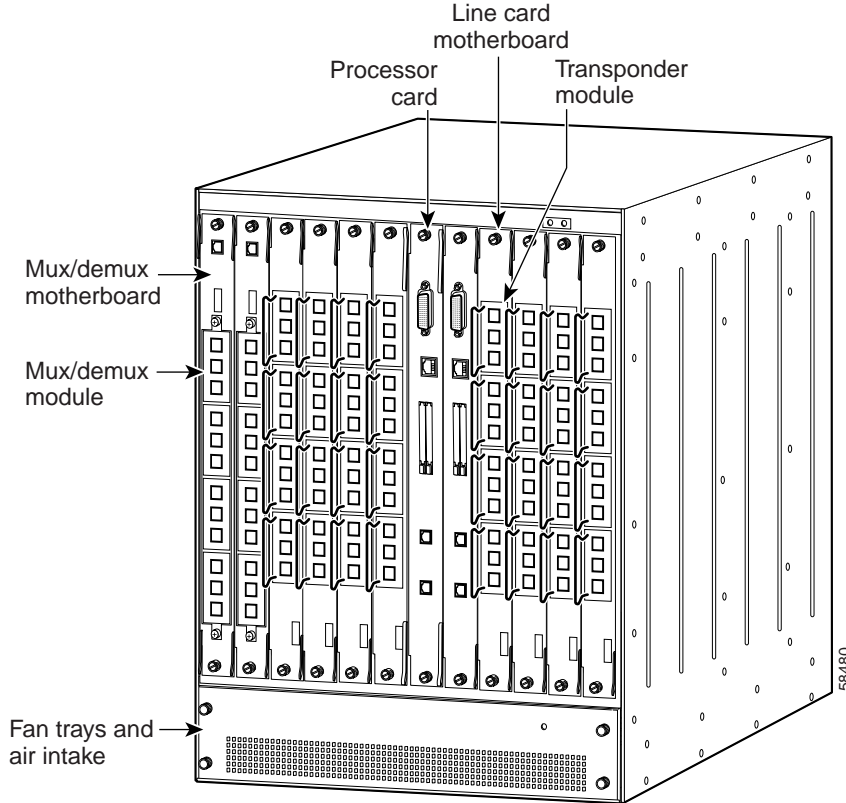

System Functional Overview

The Cisco ONS 15540 ESP connects to client equipment on one side and to the DWDM trunk (transport network) on the other side. Simply described, the Cisco ONS 15540 ESP takes a client signal and converts it to an ITU-T G.692 compliant wavelength, then optically multiplexes it with the other client signals for transmission over an optical fiber link.

The Cisco ONS 15540 ESP supports 1+1 path protection using both hardware mechanisms and software based on the APS (Automatic Protection Switching) standard. In a single-shelf configuration, a Cisco ONS 15540 ESP node can support up to 32 channels with facility (fiber) protection or 16 channels with line card protection. In a dual-shelf configuration a node can support 32 channels with line card protection. The Cisco ONS 15540 ESP can be deployed in point-to-point, linear add/drop, hubbed ring, and meshed ring topologies.

Figure 1-2 illustrates the principal functions involved in transmission of the signal between the client and trunk networks within the Cisco ONS 15540 ESP. In the transmit direction, these functions include receiving the client signal by a transceiver, converting the client signal in the transponder, transmitting the signal over the optical backplane, and multiplexing the signal with other client signals before putting it on the fiber. The opposite functions are performed in the receive direction.

Figure 1-2 Simplified Data Flow Architecture

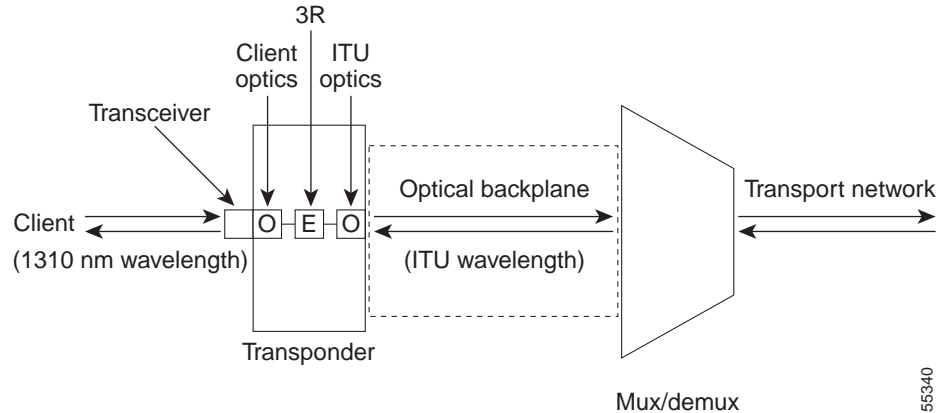

The client signal is received through a transceiver attached to the transponder module external port. Inside the transponder module the 1310-nm input optical signal is converted to an electrical signal and the 3R (reshape, retune, retransmit) function is performed. A modulated laser diode then converts the electrical signal back to an optical one with a specific wavelength that complies with the ITU laser grid.

The optical signal leaves the transponder module and travels across the optical backplane, which is an optical fiber array circuit comprised of fiber ribbon cables. This backplane serves as a fixed optical cross connection between the transponder modules and the optical mux/demux modules. For a detailed description of the optical backplane, see the [“Optical Backplane” section on page 2-3](#).

Inside the optical mux/demux module the input signals are multiplexed into a single DWDM signal and launched into the fiber on the trunk side. Thus, there is a one-to-one relationship between each client signal and each wavelength on the trunk side.

The Cisco ONS 15540 ESP is a duplex system; therefore where there are light emitters there are also light detectors. For example, the client side interfaces on the transponder modules both transmit and receive light. The same is true of the transponder’s DWDM interface. Also, the optical mux/demux modules both multiplex the transmit signal and demultiplex the receive signal.

System Components

The Cisco ONS 15540 ESP has a modular architecture that allows flexibility in configuration and permits incremental upgrades of the system. These components are described in the following sections.

Transponder Modules

The Cisco ONS 15540 ESP supports three types of 2.5-Gbps transponder modules: Type 1 SM (single mode), Type 1 MM (multimode), and 2.5-Gbps Type 2 extended range with SFP optics.

The transponder modules populate the line card motherboards and have two interfaces: an external interface that connects to client equipment, and an internal interface that connects to the line card motherboard.

In the transponder module, the client signal is regenerated and retransmitted on an ITU-compliant wavelength across the optical backplane.

The laser on each 2.5-Gbps transponder module is capable of generating one of two wavelengths on the trunk side. Thus, there are 16 different transponder modules (for channels 1–2, 3–4, ..., 31–32) to support the 32 channels; each module is available in both SM and MM versions. The software determines which wavelength a module generates based on the subslot it occupies in the line card motherboard. A module that is inserted in subslot 0 or 2 transmits on the lower of its two channels; a module inserted into subslot 1 or 3 transmits on its upper channel.

A safety protocol, LSC (laser safety control), shuts the transmit laser down on the trunk side when a fiber break or removed connector is detected. The transponder modules are hot pluggable, permitting in-service upgrades and replacement.

SM Transponder Modules and MM Transponder Modules

The client interface on the Type 1 transponder module is protocol transparent and bit-rate transparent and accepts either a single-mode or multimode client signal on the 1310-nm wavelength through SC connectors. The multimode transponder can handle 62.5 μm MM, 50 μm MM, and 9 or 10 μm SM fiber; the single-mode transponder can handle 50 μm MM fiber and 9 or 10 μm SM fiber.

The transponder interfaces support encapsulation of client signals in either 3R enhanced mode, which allows some client protocol monitoring (such as code violations and data errors) or regular 3R mode, where the transponder is transparent to the client data stream. In either case, the content of the client data stream remains unmodified. Configurable failure and degrade thresholds for monitored protocols are also supported.

Table 1-1 shows the common client signal encapsulations supported on the single-mode transponder modules and multimode transponder modules.

Table 1-1 Common Client Signal Encapsulations Supported on Single-Mode and Multimode Transponders

Client Signal Encapsulation	Fiber Type	Wavelength (nm)		Transponder Type		Protocol Monitoring
		1310	850	SM	MM	
Gigabit Ethernet (1250 Mbps)	SM 9 or 10/125 μm	Yes	No	Yes	No	Yes
	MM 50/125 μm	Yes	No	No	No	Yes
	MM 62.5/125 μm	Yes	No	No	No	—
Fast Ethernet (100 Mbps)	SM 9 or 10/125 μm	Yes	No	Yes	Yes	No
	MM 50/125 μm	Yes	No	Yes	Yes	No
	MM 62.5/125 μm	Yes	No	No	Yes	No
SONET STS-3/ SDH STM-1 (OC-3) (155 Mbps)	SM 9 or 10/125 μm	Yes	No	Yes	Yes	Yes
	MM 50/125 μm	Yes	No	Yes	Yes	Yes
	MM 62.5/125 μm	Yes	No	No	Yes	Yes

Table 1-1 Common Client Signal Encapsulations Supported on Single-Mode and Multimode Transponders (continued)

Client Signal Encapsulation	Fiber Type	Wavelength (nm)		Transponder Type		Protocol Monitoring
		1310	850	SM	MM	
SONET STS-12/SDH STM-4 (OC-12) (622 Mbps)	SM 9 or 10/125 μ m	Yes	No	Yes	Yes	Yes
	MM 50/125 μ m	Yes	No	Yes	Yes	Yes
	MM 62.5/125 μ m	Yes	No	No	Yes	Yes
SONET STS-48/SDH STM-16 (OC-48) (2488 Mbps)	SM 9 or 10/125 μ m	Yes	No	Yes	No	Yes
	MM 50/125 μ m	Yes	No	Yes	No	Yes
	MM 62.5/125 μ m	Yes	No	No	No	—
ATM 155 (OC-3) (155 Mbps)	SM 9 or 10/125 μ m	Yes	No	Yes	Yes	Yes
	MM 50/125 μ m	Yes	No	Yes	Yes	Yes
	MM 62.5/125 μ m	Yes	No	No	Yes	Yes
Fiber Channel (1062 Mbps)	SM 9 or 10/125 μ m	Yes	No	Yes	No	Yes
	MM 50/125 μ m	Yes	No	Yes	No	Yes
	MM 62.5/125 μ m	Yes	No	No	No	—
Fiber Channel (2125 Mbps)	SM 9 or 10/125 μ m	Yes	No	Yes	No	Yes
	MM 50/125 μ m	Yes	No	Yes	No	Yes
	MM 62.5/125 μ m	Yes	No	No	No	—
FDDI (125 Mbps)	SM 9 or 10/125 μ m	Yes	No	Yes	Yes	No
	MM 50/125 μ m	Yes	No	Yes	Yes	No
	MM 62.5/125 μ m	Yes	No	No	Yes	No

Table 1-2 shows the IBM storage protocols on the single-mode and multimode transponders.

Table 1-2 IBM Storage Protocols Supported on Single-Mode and Multimode Transponders

Client Signal Encapsulation	Fiber Type	Wavelength (nm)		Transponder Type		Protocol Monitoring
		1310	850	SM	MM	
ESCON (200 Mbps)	SM 9 or 10/125 μ m	Yes	No	Yes	Yes	Yes
	MM 50/125 μ m	Yes	No	Yes	Yes	Yes
	MM 62.5/125 μ m	Yes	No	No	Yes	Yes
FICON (1062 Mbps)	SM 9 or 10/125 μ m	Yes	No	Yes	No	Yes
	MM 50/125 μ m	Yes	No	Yes ¹	No	Yes
	MM 62.5/125 μ m	Yes	No	Yes ²	No	Yes
FICON (2125 Mbps)	SM 9 or 10/125 μ m	Yes	No	Yes	No	Yes
	MM 50/125 μ m	Yes	No	Yes ²	No	Yes
	MM 62.5/125 μ m	Yes	No	Yes ²	No	Yes

Table 1-2 IBM Storage Protocols Supported on Single-Mode and Multimode Transponders (continued)

Client Signal Encapsulation	Fiber Type	Wavelength (nm)		Transponder Type		Protocol Monitoring
		1310	850	SM	MM	
Coupling Facility, ISC ³ compatibility (1062 Mbps)	SM 9 or 10/125 μ m	Yes	No	Yes	No	Yes
	MM 50/125 μ m	Yes	No	Yes ²	No	Yes
	MM 62.5/125 μ m	No	No	—	—	—
Coupling Facility, ISC peer (2125 Mbps)	SM 9 or 10/125 μ m	Yes	No	Yes	No	No
	MM 50/125 μ m	No	No	—	—	—
	MM 62.5/125 μ m	No	No	—	—	—
Sysplex Timer (ETR and CLO) (8 Mbps ⁴)	SM 9 or 10/125 μ m	No	No	—	—	—
	MM 50/125 μ m	Yes	No	No	Yes	No
	MM 62.5/125 μ m	Yes	No	No	Yes	No

1. These protocols require the use of a special mode-conditioning patch cable (available from IBM) at each end of the connection.
2. These protocols require the use of a special mode-conditioning patch cable (available from IBM) at each end of the connection.
3. ISC = InterSystem Channel
4. Sysplex Timer is the only protocol supported at a clock rate less than 16 Mbps.

Table 1-3 shows some other common protocols that are supported on the single-mode and multimode transponders without protocol monitoring.

Table 1-3 Other Client Signal Encapsulations Supported on Single-Mode and Multimode Transponders

Client Signal Encapsulation	Fiber Type	Wavelength (nm)		Transponder Type		Protocol Monitoring
		1310	850	SM	MM	
DS3 (45 Mbps)	SM 9 or 10/125 μ m	Yes	No	Yes	Yes	No
	MM 50/125 μ m	Yes	No	Yes	Yes	No
	MM 62.5/125 μ m	Yes	No	No	Yes	No
OC-1 (51.52 Mbps)	SM 9 or 10/125 μ m	Yes	No	Yes	Yes	No
	MM 50/125 μ m	Yes	No	Yes	Yes	No
	MM 62.5/125 μ m	Yes	No	No	Yes	No
OC-24 (933.12 Mbps)	SM 9 or 10/125 μ m	Yes	No	Yes	No	No
	MM 50/125 μ m	Yes	No	Yes	No	No
	MM 62.5/125 μ m	Yes	No	No	No	No

Additional discrete rates are also supported in regular 3R mode. For the SM transponder modules, these rates fall between 16 Mbps and 2.5 Gbps; for the MM transponder modules, the rates are between 16 Mbps and 622 Mbps.

**Note**

Rates from 851,000 Kbps to 999,999 Kbps and from 160,1000 Kbps to 1,999,999 Kbps are not supported.

The system supports OFC (open fiber control) for Fibre Channel and ISC encapsulations. Alternatively, FLC (forward laser control) can be enabled to shut down the laser on the client or trunk side if a LOL (loss of light) is detected on the other side.

The Cisco ONS 15540 ESP transponder modules support autonegotiation for Gigabit Ethernet traffic.

**Note**

The Cisco ONS 15540 ESP SM and MM transponder modules do not support autonegotiation for 2-Gbps Fibre Channel. The transponder modules only recognize the configured clock rate or protocol encapsulation.

For detailed information about client interface configuration, refer to the [Cisco ONS 15540 ESP Configuration Guide and Command Reference](#).

Type 2 Extended Range Transponder Modules with SFP Optics

The Type 2 extended range transponder module accepts two types of SFP optics:

- Fixed rate
- Variable rate

Fixed rate SFP optics modules support specific protocols. [Table 1-4](#) lists the features for the fixed rate SFP optics supported by the Type 2 extended range transponder modules.

Table 1-4 Fixed Rate SFP Optics Features

Part Number	Supported Protocols	Fiber Type	Wavelength	Connector Type
15500-XVRA-01A2	ESCON, SONET OC-3 SR, SDH STM-1	MM 50/125 μ m MM 62.5/125 μ m	1310 nm	MT-RJ
15500-XVRA-02C1	Gigabit Ethernet ¹ , Fibre Channel (1 Gbps) ² , FICON (1 Gbps), ISC-1 (1-Gbps)	MM 50/125 μ m MM 62.5/125 μ m	850 nm	LC
15500-SFP-GEFC-SX	Fibre Channel (1 Gbps and 2 Gbps) ³ , FICON (1 Gbps and 2 Gbps), ISC-3 (1-Gbps and 2-Gbps), Gigabit Ethernet	MM 50/125 μ m MM 62.5/125 μ m	850 nm	LC
15500-XVRA-03B1	Gigabit Ethernet ⁴ , Fibre Channel (1 Gbps) ⁵ , FICON (1 Gbps), ISC compatibility mode (1 Gbps), ISC peer mode (1 Gbps)	SM 9/125 μ m	1310 nm	LC

Table 1-4 Fixed Rate SFP Optics Features (continued)

Part Number	Supported Protocols	Fiber Type	Wavelength	Connector Type
15500-XVRA-03B2	Fibre Channel (1 Gbps ⁶ and 2 Gbps ⁷), FICON (1 Gbps and 2 Gbps), ISC compatibility mode (1 Gbps), ISC peer mode (1 Gbps and 2 Gbps)	SM 9/125 µm	1310 nm	LC
15500-XVRA-06B1	SONET OC-12 SR ⁸ , SDH STM-4	SM 9/125 µm	1310 nm	LC
15500-XVRA-07B1	SONET OC-48 SR, SDH STM-16	SM 9/125 µm	1310 nm	LC

1. 1000BASE-SX
2. FC-0-100-M5-SN-S and FC-0-100-M6-SN-S standards
3. FC-0-200-M5-SN-S and FC-0-200-M6-SN-S standards
4. 1000BASE-LX
5. FC-0-100-SM-LC-S standard
6. FC-0-100-SM-LC-S standard
7. FC-0-200-SM-LC-S standard
8. SR = short range

Variable rate SFP optics modules support a range of clock rates. [Table 1-5](#) lists features for the variable rate SFP optics supported by the Type 2 extended range transponder modules.

Table 1-5 Variable Rate SFP Optics Features

Part Number	Clock Rate Range	Protocol Encapsulations Supported	Fiber Type	Wavelength	Connector Type
15500-XVRA-10A1	Low-band 8 Mbps to 200 Mbps	Sysplex (CLO and ETR) ¹ (8 Mbps), Fast Ethernet ² (125 Mbps), SONET OC-3 ³ (155.52 Mbps), SDH STM-1 (622 Mbps), ESCON ⁴ (200 Mbps)	MM 50/125 µm 62.5/125 µm	1310 nm	LC
15500-XVRA-10B1	Low-band 8 Mbps to 200 Mbps	Sysplex (CLO and ETR) ¹ (8 Mbps), Fast Ethernet ² (125 Mbps), SONET OC-3 ³ (155.52 Mbps), SDH STM-1 (155.52 Mbps), ESCON ⁴ (200 Mbps)	SM 9/125 µm	1310 nm	LC
15500-XVRA-11A1	Mid-band 200 Mbps to 622 Mbps	ESCON ⁴ (200 Mbps), SONET OC-12 ³ (622 Mbps), SDH STM-4 (622 Mbps)	MM 50/125 µm 62.5/125 µm	1310 nm	LC

Table 1-5 Variable Rate SFP Optics Features (continued)

Part Number	Clock Rate Range	Protocol Encapsulations Supported	Fiber Type	Wavelength	Connector Type
15500-XVRA-11B1	Mid-band 200 Mbps to 1.25 Gbps	ESCON ⁴ (200 Mbps), SONET OC-12 ³ (622 Mbps), SDH STM-4 (622 Mbps), FC ⁴ (1.062 Gbps), FICON (1.062 Gbps), GE ⁴ (LX) (1.250 Gbps) ISC compatibility mode (1.062 Gbps), ISC peer mode (1.062 Gbps)	SM 9/125 μm	1310 nm	LC
15500-XVRA-12B1	High-band 1.062 Gbps to 2.488 Gbps	FC ⁴ (1.062 Gbps and 2.125 Gbps), FICON (1.062 Gbps and 2.125 Gbps), GE ⁴ (LX) (1.250 Mbps), SONET OC-48 (2.488 Gbps), SDH STM-16 (2.488 Gbps), ISC compatibility mode (1.062 Gbps), ISC peer mode (1.062 Gbps and 2.125 Gbps)	SM 9/125 μm	1310 nm	LC

1. Manchester coded
2. 4B/5B coded
3. Scrambler 2²³⁻¹
4. 8B/10B coded

**Note**

The Cisco IOS software only supports Cisco-certified SFP optics on the Type 2 extended range transponder module.

The following protocols can be monitored with the Type 2 extended range transponder modules:

- ESCON (Enterprise Systems Connection)
- Fibre Channel (1 Gbps and 2 Gbps)
- FICON (Fiber Connection) (1 Gbps and 2 Gbps)
- Gigabit Ethernet
- ISC (compatibility mode)
- SDH (Synchronous Digital Hierarchy) (STM-1, STM-4, STM-16)
- SONET (OC-3, OC-12, OC-48)

For detailed information about client interface configuration, refer to the [Cisco ONS 15540 ESP Configuration Guide](#).

The Type 2 extended range transponder modules also support the OFC (open fiber control) safety protocol for Fibre Channel.

The Cisco ONS 15540 ESP Type 2 extended range transponder modules support autonegotiation for Gigabit Ethernet traffic.

**Note**

The Cisco ONS 15540 ESP Type 2 extended range transponder modules do not support autonegotiation for 2-Gbps Fibre Channel. The transponder modules only recognize the configured clock rate or protocol encapsulation.

**Caution**

The SFP optics supported by the Type 2 extended range transponder modules yield optimal performance at the data rates for which the transceivers are explicitly designed. Configuring a protocol encapsulation or clock rate outside of the clock rate specifications for the transceiver could result in suboptimal performance, depending on the transceiver characteristics (such as receiver sensitivity and output power).

For information on transceiver specifications, refer to the [Cisco ONS 15540 ESP Hardware Installation Guide](#).

Conditions Monitored on 2.5-Gbps Transponder Modules

For GE, FC, and FICON traffic, the Cisco ONS 15540 ESP monitors the following conditions:

- CVRD (code violation running disparity) error counts
- Loss of Sync
- Loss of Lock
- Loss of Light

For SONET errors, the Cisco ONS 15540 ESP monitors the SONET section overhead only, not the SONET line overhead. Specifically, the Cisco ONS 15540 ESP monitors the B1 byte and the framing bytes. The system can detect the following defect conditions:

- Loss of Light
- Loss of Lock (when the clock cannot be recovered from the received data stream)
- Severely errored frame
- Loss of Frame

For SONET performance, the system monitors the B1 byte, which is used to compute the four SONET section layer performance monitor parameters:

- SEFS-S (second severely errored framing seconds)
- CV-S (section code violations)
- ES-S (section errored seconds)
- SES-S (section severely errored seconds)

For ISC traffic, the system monitors the following conditions:

- CVRD error counts
- Loss of CDR (clock data recovery) Lock
- Loss of Light

2.5-Gbps Line Card Motherboards

The 2.5-Gbps line card motherboards hold the 2.5-Gbps transponder modules and provide the optical connections from the transponder modules to the optical backplane. The line card motherboards are modular and can be populated according to user needs. A single system can hold up to eight line card motherboards, each of which accepts four 2.5-Gbps transponder modules.

There are three types of line card 2.5-Gbps motherboards: splitter, east, and west. The splitter 2.5-Gbps motherboard supports protection against fiber failure by delivering the ITU wavelengths emitted from their associated 2.5-Gbps transponder modules over the optical backplane to the optical mux/demux modules in both the west and east slots (slots 0 and 1, respectively). The east and west 2.5-Gbps line card motherboards deliver the ITU wavelengths from their associated transponder modules over the optical backplane to the optical mux/demux modules in either the east or west slot.

Mux/Demux Motherboards

The mux/demux motherboards hold the optical mux/demux modules. Either slot 0 or slot 1 can be populated with a single mux/demux motherboard for unprotected operation, or both slots can be populated for protected operation. Each motherboard can accept up to four optical mux/demux modules, depending upon the type of module used, and can be populated according to user needs.

OSC

There are two versions of the mux/demux motherboard, with and without the OSC (optical supervisory channel). Implemented with a dedicated laser and detector for a 33rd wavelength (channel 0) on the mux/demux motherboard, the OSC is a per-fiber duplex management channel for communicating between Cisco ONS 15540 ESP systems. The OSC allows control and management traffic to be carried without the necessity of a separate Ethernet connection to each Cisco ONS 15540 ESP in the network.

The OSC is established over a point-to-point connection and is always terminated on a neighboring node. By contrast, data channels may or may not be terminated on a given node, depending on whether the channels are express (pass-through) or add/drop.

The OSC carries the following types of information:

- CDP (Cisco Discovery Protocol) packets—Used to discover neighboring devices
- IP packets—Used for SNMP and Telnet sessions between nodes
- OSCP (OSC Protocol)—Used to determine whether the OSC link is up
- APS protocol packets—Used for controlling signal path switching



Note

A Cisco ONS 15540 ESP system on which the OSC is not present is not known to other systems in the network and cannot be managed by any NMS. Without the OSC, a Cisco ONS 15540 ESP system must be managed individually by separate Ethernet or serial connections. Thus, it is important when adding a node to an existing network of Cisco ONS 15540 ESP systems that the added node have OSC support.

Optical Mux/Demux Modules

The optical mux/demux modules are passive devices that optically multiplex and demultiplex a specific band of ITU wavelengths. In the transmit direction, the optical mux/demux modules multiplex signals transmitted by the transponder modules over the optical backplane and provide the interfaces to connect the multiplexed signal to the DWDM trunk side. In the receive direction, the optical mux/demux modules demultiplex the signals from the trunk side before passing them over the optical backplane to the transponder modules.

Optical Mux/Demux Modules and Channel Bands

There are two types of optical mux/demux modules, add/drop and terminal, and each module supports a range of channels called a *band*. In the case of the add/drop mux/demux modules, a band contains 4 or 8 channels; in the case of the terminal mux/demux modules, a band contains 16 channels.

[Table 1-6](#) lists the optical mux/demux modules that support each channel band. All modules except the 16-channel band AD module are available with or without OSC support. The AD module is available only with the OSC. For correspondence between channel numbers and wavelengths on the ITU grid, refer to the [Cisco ONS 15540 ESP Hardware Installation Guide](#).

Table 1-6 Optical Mux/Demux Modules and Supported Channel Bands

Cisco ONS 15540 ESP Channels	4-Channel Add/Drop Mux/Demux Module	8-Channel Add/Drop Mux/Demux Module	16-Channel Terminal Mux/Demux Module ¹
1–4	Band A	Band AB	Band AD
5–8	Band B		
9–12	Band C		
13–16	Band D	Band CD	Band EH
17–20	Band E		
21–24	Band F		
25–28	Band G	Band GH	
29–32	Band H		

1. A 16-channel terminal mux/demux module occupies two subslots in a mux/demux motherboard.

Add/Drop Mux/Demux Modules

An add/drop mux/demux module adds a specified band of channels at a node and passes the other bands through. To support the 32-channel spectrum, there are eight different 4-channel modules and four different 8-channel modules.

[Figure 1-3](#) shows the physical layout of the add/drop mux/demux module along with a logical view of its multiplexing and demultiplexing functions. Optical signals received from the transponder, the Thru IN connector, and the OSC IN connector are multiplexed and sent through the Trunk OUT connector. The optical signal received from the Trunk IN connector is demultiplexed and the OSC signal is sent to the OSC OUT connector; the dropped channels are sent to the transponder; and the passed channels are sent to the Thru OUT connector.

Figure 1-3 Add/Drop Mux/Demux Module

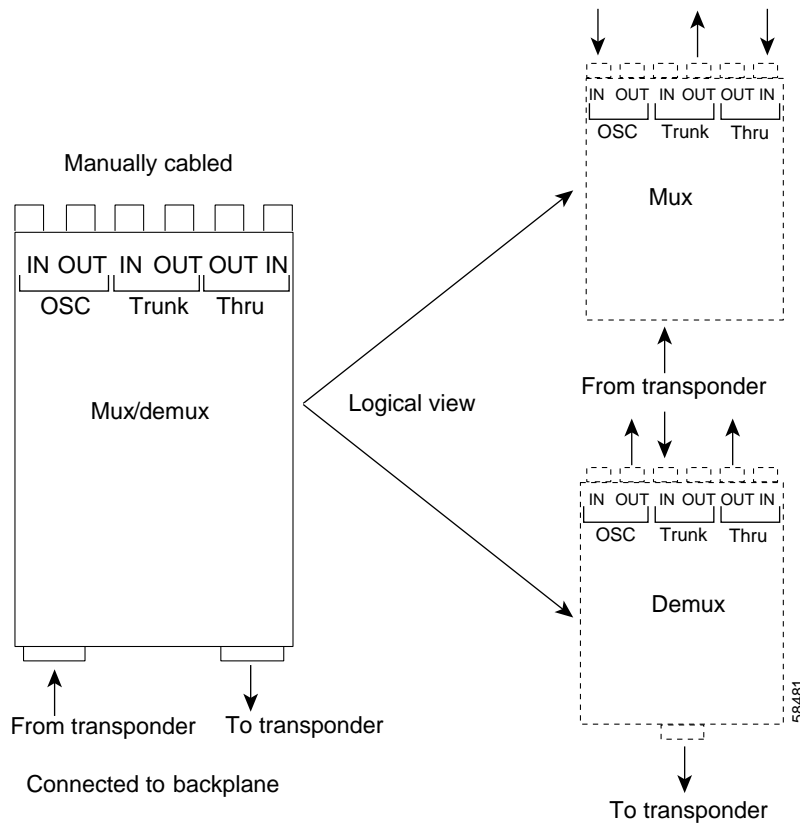

Terminal Mux/Demux Modules

The terminal mux/demux modules are based on interleaver technology and only support the ITU wavelengths within the specified band. Wavelengths outside the specified band are inaccessible. Terminal mux/demux modules are supplied in two 16-channel versions. The first, which supports band AD (channels 1–16), can be used alone, while the second, which supports band EH (channels 17–32), must be used in conjunction with the first. A 16-channel module occupies two subslots in the mux/demux motherboard.

Because of their more favorable optical power loss characteristics, the terminal mux/demux modules may be preferred at nodes where selective add/drop is not required, such as in a point-to-point configuration or at the hub node in a hubbed ring.

Optical Mux/Demux Module Configurations

The modular nature of the mux/demux motherboard allows optical mux/demux modules to be added as needed to support the desired number of client signals. In the case of the 16-channel modules, the shelf can be upgraded to 32 channels with the addition of the second 16-channel module. In the case of add/drop nodes, the capacity can be increased with the addition of 4- or 8-channel modules to support increased channel demand or the requirements of a meshed ring.

The 4- or 8-channel add/drop modules are combined in a cascading fashion using fiber optical cables with MU connectors. Figure 1-4, for example, shows how two 4-channel modules are cabled together to upgrade a point-to-point configuration from 4 channels to 8 channels.

Figure 1-4 Cascaded 4-Channel Mux/Demux Modules

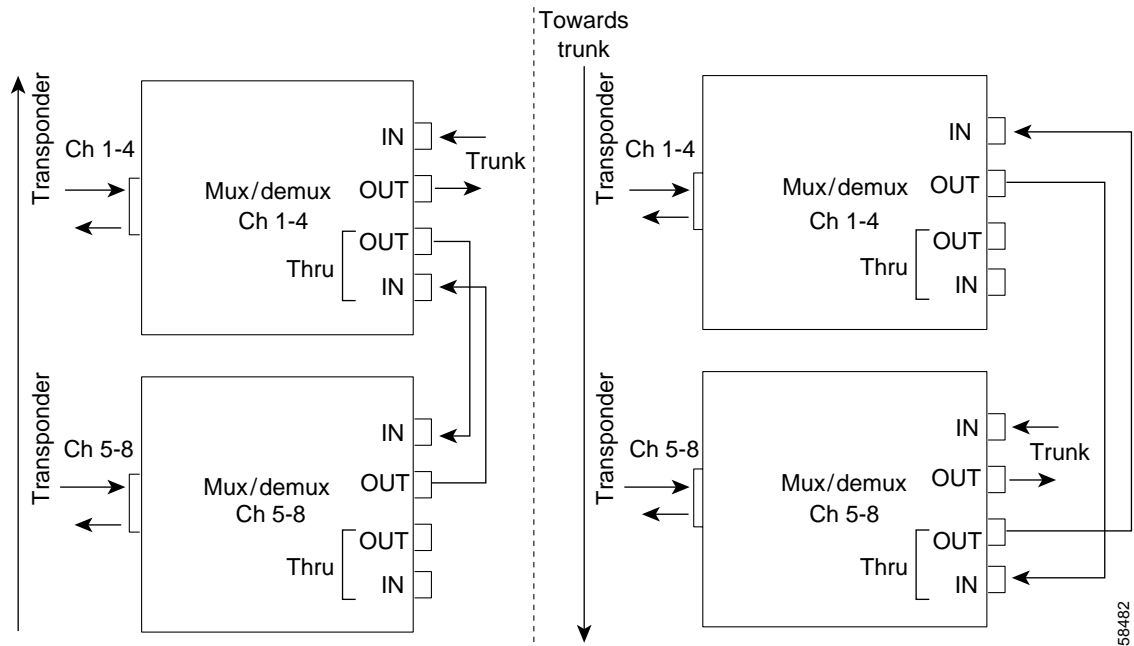

In ring configurations, channels that are not destined for a particular node are passed through that node and sent back on the ring. Figure 1-5 shows an example of how two 4-channel mux/demux modules might be cabled in a protected ring configuration.

Figure 1-5 4-Channel Mux/Demux Modules in a Protected Ring Configuration

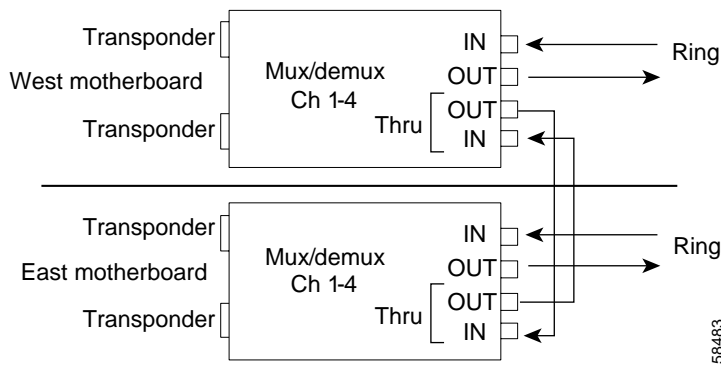

In some ring topologies, cascading add/drop mux/demux modules may be required to support the add/drop requirements of the configuration. Figure 1-6 shows one example.

Figure 1-6 Cascaded Add/Drop Mux/Demux Modules in a Protected Ring Configuration

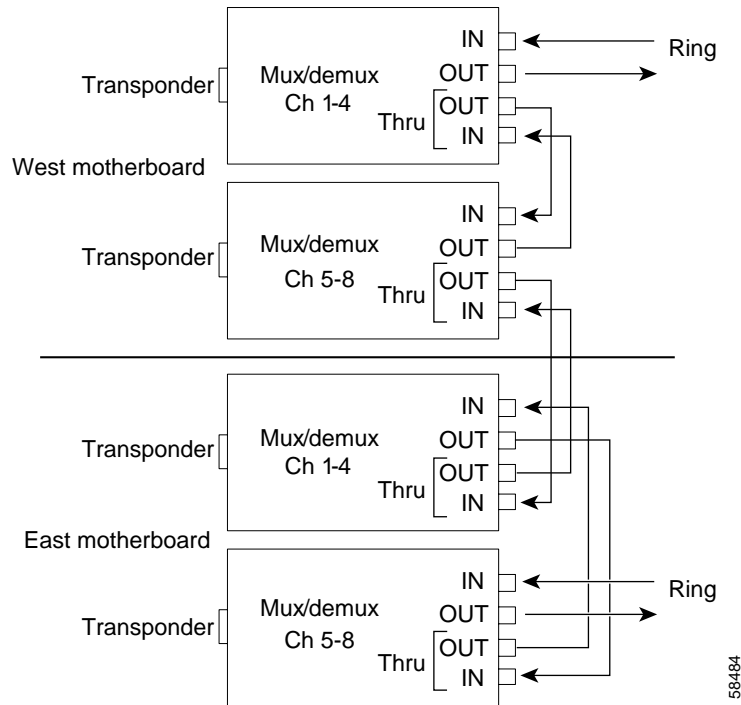

Processors Cards

The Cisco ONS 15540 ESP includes two processor cards for redundancy. Each processor is composed of a number of subsystems, including a CPU, a system clock, Ethernet switch for communicating between processors and with the LRC (line card redundancy controller) on the mux/demux and line card motherboards, and a processor redundancy controller. The active processor controls the node, and all cards in the system make use of the system clock and synchronization signals from the active processor.

The processor card is equipped with a console port, a Fast Ethernet interface for Telnet access and network management, and an auxiliary port. There are two slots for Flash PC Cards.

On the processor card front panel are LEDs that display the status of critical, major, and minor signals, as well as the status of alarm cutoff and history conditions. The alarm signals from the processor go to an alarm daughterboard on the backplane, which has a connector for central office alarm facilities.

The system processors run Cisco IOS software and support the following features:

- Automatic configuration at startup
- Automatic discovery of network neighbors
- Online self-diagnostics and tests
- SSH (Secure Shell)
- Arbitration of processor status (active/standby) and switchover in case of failure without loss of connections
- Automatic synchronization of startup and running configurations
- Autosynchronization of traffic statistics and performance monitoring counters.
- In-service software upgrades

- Per-channel APS (Automatic Protection Switching) in linear and ring topologies using redundant subsystems that monitor link integrity and signal quality
- System configuration and management through the CLI (command-line interface) and SNMP
- Optical power monitoring on the trunk side, digital monitoring on the client side, and per-channel transponder in-service and out-of-service loopback (client and trunk sides)
- Optional out-of-band management of other Cisco ONS 15540 ESP systems on the network through the OSC (optical supervisory channel).

Processor Redundancy and Online Insertion and Removal

When the Cisco ONS 15540 ESP is powered up, the two processors engage in an arbitration process to determine which will be the active and which will be the standby. Previous power state information is stored in the processor non-volatile random access memory (NVRAM). The processor that was previously active reassumes the active role. During operation, the two processors remain synchronized (application states, running and startup configurations, system images). The operational status of each processor is monitored by the processor redundancy controller of the other processor through the backplane Ethernet. In the event of a failure or removal of an active processor, the standby processor immediately takes over and assumes the active role. Once the problem on the faulty card has been resolved, it can be manually restored to the active function.

In addition to providing protection against hardware or software failure, the redundant processor arrangement also permits installing a new Cisco IOS system image without system downtime. For more information about processor redundancy operation, as well as other software features, refer to the [Cisco ONS 15540 ESP Configuration Guide](#).

Security Features

The Cisco ONS 15540 ESP supports the following Cisco IOS software security features:

- AAA (authentication, authorization, and accounting)
- Kerberos
- RADIUS
- TACACS+
- SSH
- Traffic filters and firewalls
- Passwords and privileges

For detailed information about the security features supported on the Cisco ONS 15540 ESP, refer to the [Cisco IOS Security Configuration Guide](#).

System and Network Management

The Cisco ONS 15540 ESP is fully manageable through any of the following two mechanisms: the OSC and a direct Ethernet connection to the NME (network management Ethernet) on the processor card. While all shelves will be equipped with at least one processor card, provisioning the OSC is optional.

All three mechanisms can be deployed within a single network. Each mechanism is associated with an interface that can be assigned an IP address. Management information will be routed between these interfaces.

Different levels of availability exist for each of these management mechanisms. High availability for the direct NME connection can be achieved with redundant processor cards. The OSC becomes highly available when it is provisioned on both the working and protection trunk fibers.

NME

The NME is a 10/100 Ethernet port on the processor card. You can connect this port to a router and configure the interface to route messages using established routing protocols. The NME can be used to carry traffic to a network management system.



Note

The NME provides little in the way of topology management or fault isolation. We recommend using the OSC to manage and troubleshoot your network topology.

NME Considerations

The following considerations apply to the NME:

- To remotely manage nodes in the network topology using the NME, each system must be accessible through an IP network.
- The NME port is present on every processor card and does not require extra equipment or a slot in the shelf.

Comparison of the OSC and SONET

Table 1-7 compares the features provided by the OSC and SONET.

Table 1-7 Comparison of the SONET, and OSC

Feature	OSC	SONET ¹
Management reach	Per fiber section	Per wavelength
Fault isolation and topology discovery	Hop-by-hop fiber (physical topology)	End-to-end wavelength (logical topology)
Payload	Separate out-of-band channel	SONET (OC-n)
Management channel	Per fibre via a 33rd wavelength (channel 0)	Per wavelength via section DCC
Performance monitoring	OSC protocol	Section BIP ²

1. SONET based management is not supported on the Cisco ONS 15540 ESP.

2. BIP = bit interleaved parity



Protection Schemes and Network Topologies

This chapter describes how protection is implemented on the Cisco ONS 15540. It also describes the supported network topologies and how protection works in these topologies. This chapter contains the following major sections:

- [Protection Against Fiber and System Failures, page 2-1](#)
- [Supported Topologies, page 2-6](#)

Protection Against Fiber and System Failures

The design of the Cisco ONS 15540 provides for two levels of network protection, facility protection and line card protection. Facility protection provides protection against failures due to fiber cuts or unacceptable signal degradation on the trunk side. Line card protection provides protection against failures both on the fiber and in the transponders, which contain the light emitting and light detecting devices as well as the 3R electronics. Line card protection can also be implemented using redundant client signals. This provides protection against the failure of the client, the transponder, or the fiber.

Splitter Based Facility Protection

To survive a fiber failure, fiber optic networks are designed with both working and protection fibers. In the event of a fiber cut or other facility failure, working traffic is switched to the protection fiber. The Cisco ONS 15540 supports such facility protection using a *splitter* scheme (see [Figure 2-1](#)) to send the output of the DWDM transmitter on two trunk side interfaces.

Figure 2-1 Splitter Protection Scheme

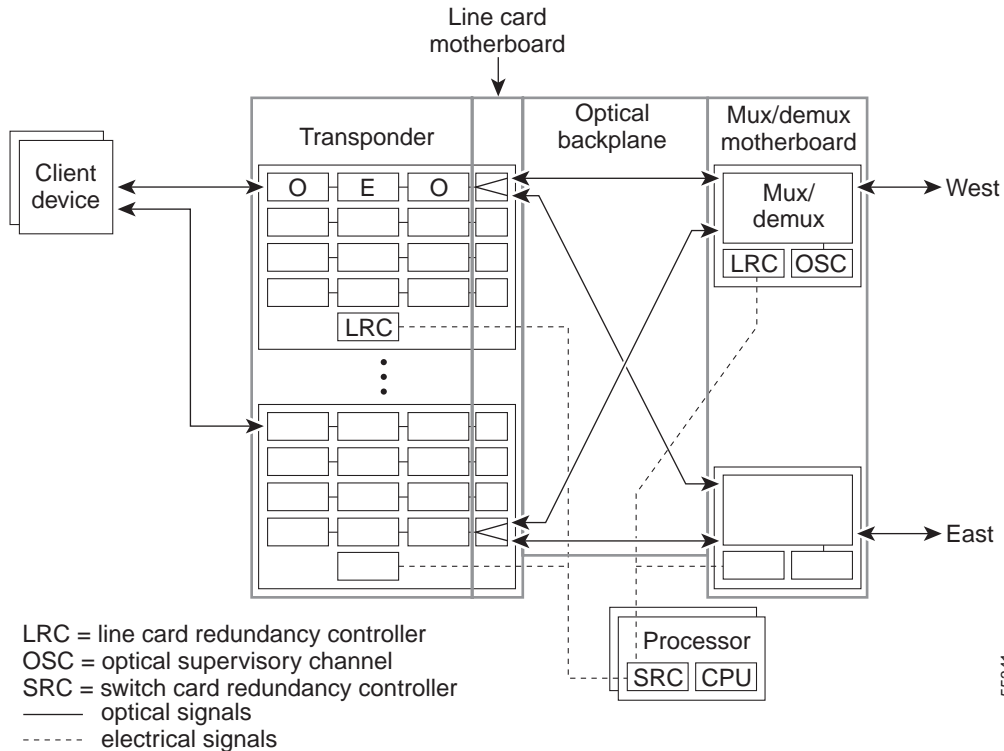

With splitter protection, splitters on the line card motherboard couples each transponder’s trunk side interface across the optical backplane to the internal interfaces on the optical mux/demux modules in the east and west slots (0 and 1). On the trunk side, one fiber pair serves as the active connection, while the other pair serves as the standby. The signal is transmitted on both connections, but in the receive direction, an optical switch selects one signal to be the active one. If a failure is detected on the active signal, a switch to the standby signal is made under control of the LRC (line card redundancy controller). Assuming, for example, that the active signal in Figure 2-1 is on the east interface, a failure of the signal on that fiber would result in a switchover, and the signal on the west interface would be selected for the receive signal.

A switchover is triggered in hardware by an Loss of Light on the receive signal. Other conditions can be specified to trigger a switchover by configuring thresholds in the APS software.

Splitter Protection Considerations

The following considerations apply when using splitter protection:

- The splitter protected line card motherboard supports splitter protection. Because the signal splitter introduces 4.6 dB of loss in the transmit direction, we recommend using the nonsplitter protected line card motherboards (east or west version) for configurations where splitter protection is not required.
- Switchover after a failure under splitter protection is nonrevertive. After a switchover, manual intervention is required to revert to using the previously failed fiber for the working traffic once the fault has been remedied.
- The OSC plays a crucial role in splitter based protection by allowing the protection fiber to be monitored for a cut or other interruption of service.

For rules on how to configure the shelf for splitter protection, see [Chapter 3, “Shelf Configuration Rules.”](#) For instructions on configuring the APS software for splitter protection, refer to the [Cisco ONS 15540 ESP Configuration Guide and Command Reference](#).

Optical Backplane

The mapping between the internal interfaces on the line card motherboards and on the optical mux/demux modules is shown in [Table 2-1](#). When the splitter protected line card motherboards are used, these cross connections, which are fixed and nonconfigurable, couple the signal from each transponder module to a specific position on the optical mux/demux modules in both slot 0 (west) and slot 1 (east). If west line card motherboards are used, the transponder modules are connected only to the optical mux/demux modules in slot 0; if the east line card motherboards are used, the transponder modules are connected only to the optical mux/demux modules in slot 1.

Table 2-1 Transponder to Optical Mux/Demux Module Mapping

Transponder Module Slot/Subslot	Optical Mux/Demux Modules Slot/Subslot		
	Splitter	West	East
2/0 through 2/3	0/0 and 1/0	0/0	1/0
3/0 through 3/3	0/0 and 1/0	0/0	1/0
4/0 through 4/3	0/1 and 1/1	0/1	1/1
5/0 through 5/3	0/1 and 1/1	0/1	1/1
8/0 through 8/3	0/2 and 1/2	0/2	1/2
9/0 through 9/3	0/2 and 1/2	0/2	1/2
10/0 through 10/3	0/3 and 1/3	0/3	1/3
11/0 through 11/3	0/3 and 1/3	0/3	1/3

Within each 8-channel range, the optical backplane maps the lower four channels (bands A, C, E, and G) to backplane connectors 1–4 on the optical mux/demux modules. The higher four channels (bands B, D, F, and H) are mapped to backplane connectors 5–8.

[Figure 2-2](#) shows this correspondence using slots 4 and 5 as the example slot pair. The transponder modules in slot 4 are mapped to backplane connectors 1–4 for mux/demux subslot 1; the transponder modules in slot 5 are mapped to backplane connectors 5–8 of the same mux/demux subslot. The backplane connections are to either slot 0 or slot 1 (if using west or east line card motherboards) or to both slot 0 and slot 1 (if using splitter protected line card motherboards).

Figure 2-2 Transponder to Optical Mux/Demux Module Mapping

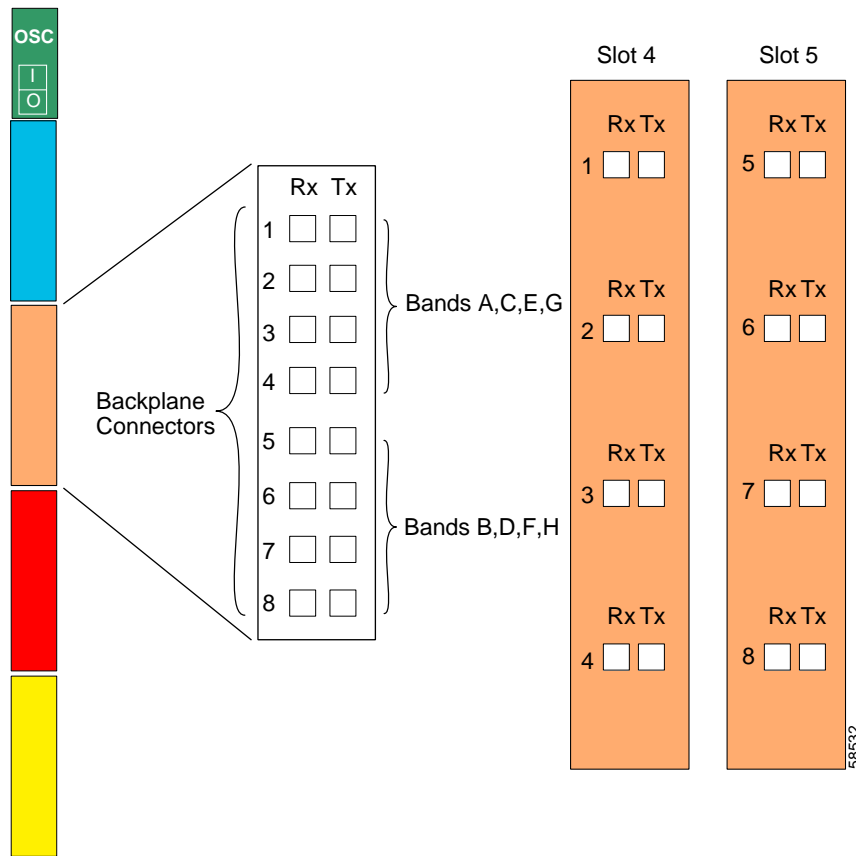

Y-Cable Based Line Card Protection

Line card protection is implemented on the Cisco ONS 15540 using a *y-cable* scheme. Y-cable protection protects against both facility failures and failure of the transponder module. Using an external 2:1 combiner (the y-cable), connections between the client equipment and the transponder interfaces are duplicated so that each input and output client signal is connected to two transponder interfaces. This arrangement is illustrated in [Figure 2-3](#).

Figure 2-3 Y-Cable Protection Scheme

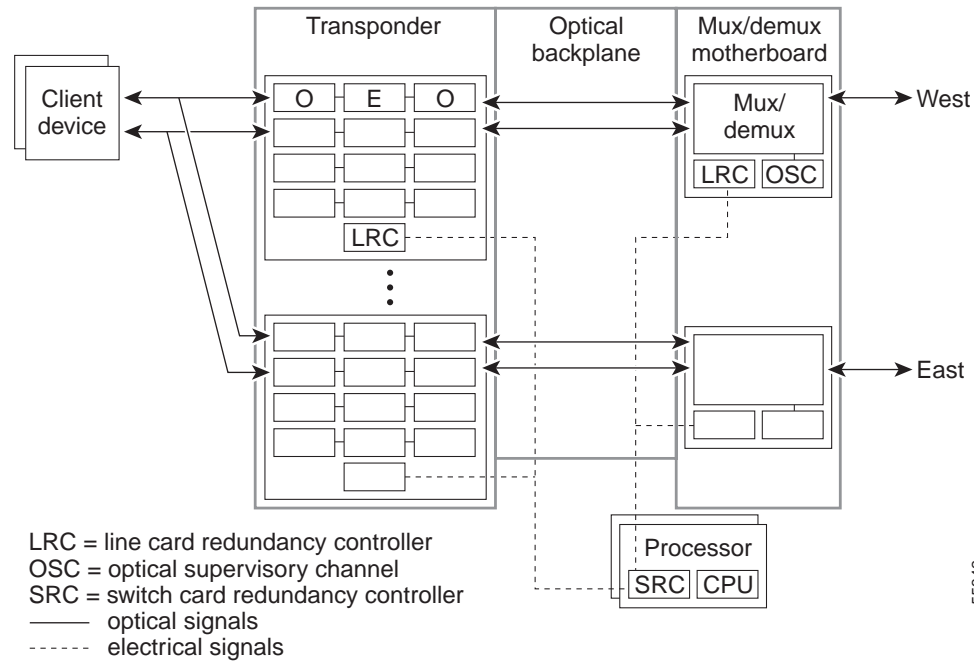

55342

During any interval, one of the transponders is functioning as the active and the other as the standby. On the working transponder, the client side laser is turned on, the trunk side laser is transmitting, and the trunk side receiver is active. On the other transponder, the client side laser is turned off (to avoid corrupting the signal back to the client), the trunk side laser is transmitting, and the trunk side receiver is standing by. The received signal on the trunk side is optically monitored by the LRC. If a loss of light, signal failure, or signal degrade is detected, and an acceptable standby signal is available, a switch to the standby signal is made. The precise conditions that trigger a switchover are configurable in the APS software.

Y-Cable Protection Considerations

The following considerations apply when using y-cable protection:

- Y-cable protection does not protect against failures of the client equipment. To protect against client failures, protection should be implemented on the client itself.
- Due to their lower optical power loss, we recommend using the nonsplitter protected line card motherboards (east or west version) for configurations with y-cable protection.
- The APS software that supports y-cable protection can be configured as revertive or nonrevertive. After a switchover, the working traffic can be put back on the previously failed fiber, once the fault has been remedied, either automatically (revertive) or through manual intervention (nonrevertive).
- Y-cable protected configurations allow monitoring of the protection fiber without the OSC.

For rules on how to configure the shelf for y-cable protection, see [Chapter 3, “Shelf Configuration Rules.”](#) For instructions on configuring the APS software for y-cable protection, refer to the [Cisco ONS 15540 ESP Configuration Guide and Command Reference](#).

Client Based Line Card Protection

While y-cable protection protects against failures in the transponders or on the fiber, the client still remains vulnerable. For some applications additional protection of the client equipment may be desirable. As Figure 2-4 shows, the same architecture that supports y-cable protection also supports client protection. The only difference is that rather than using a y-cable to split a single client signal, there are two signals from the client equipment. Operationally, client protection is also different in that signal monitoring and switchover are under control of the client rather than the protection mechanisms on the Cisco ONS 15540.

Figure 2-4 Client Based Line Card Protection Scheme

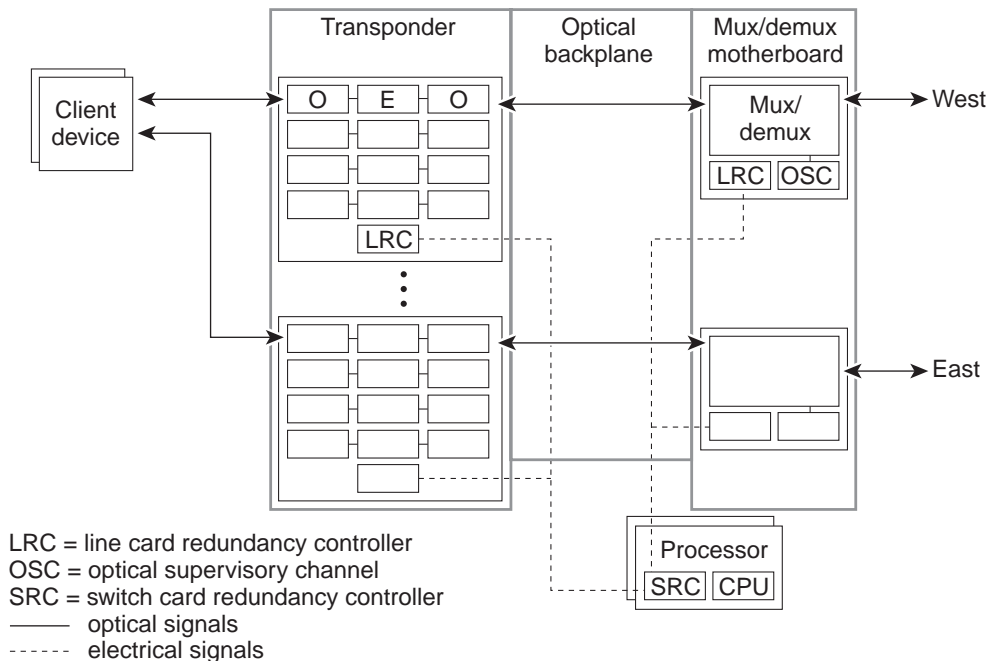

Client Protection Considerations

The following considerations apply when using client protection:

- Client protection uses the same shelf configuration as y-cable based line card protection.
- Due to their lower optical loss, we recommend using the nonsplitter protected line card motherboards (east or west version) for configurations with client protection.
- Client protected configurations allow monitoring of the protection fiber without the OSC.

Supported Topologies

The Cisco ONS 15540 can be used in linear and ring topologies. Linear topologies include protected and unprotected point-to-point and bus. Ring topologies support add/drop nodes and can be hubbed or meshed. The following sections give a brief overview of these topologies.

Linear Topologies

In a pure point-to-point topology all channels terminate on the Cisco ONS 15540 nodes at each end of the trunk. Point-to-point topologies have many common applications, including extending the reach of GE or SONET, and can be configured for unprotected or for protected operation.

Unprotected Point-to-Point Topology

Figure 2-5 shows a point-to-point topology without protection. In this configuration only one optical mux/demux slot is used in each of the Cisco ONS 15540 nodes. The west or east trunk side interface (mux/demux slot 0 or 1) of node 1 connects to the corresponding interface on node 2.

Figure 2-5 Unprotected Point-to-Point Topology

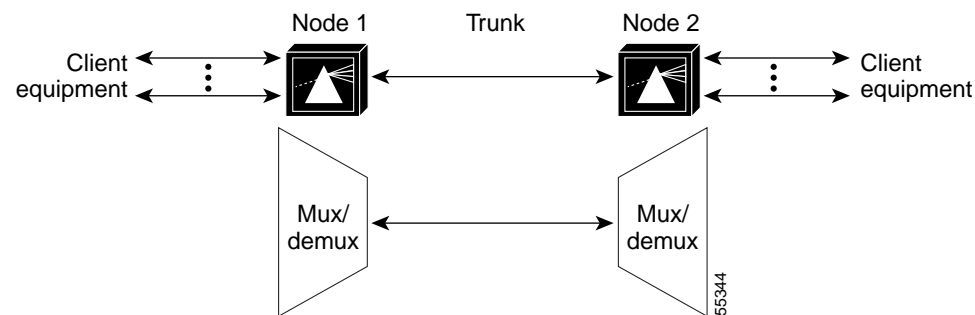

For an example configuration of an unprotected point-to-point topology, see the [“Unprotected 32-Channel Point-to-Point Configuration”](#) section on page 5-2.

Protected Point-to-Point Topology

Figure 2-6 shows a protected point-to-point topology. The Cisco ONS 15540 system can be configured for splitter or line card protection. In either case, there are two trunk side interfaces, west and east, connected by two fiber pairs.

Figure 2-6 Protected Point-to-Point Topology

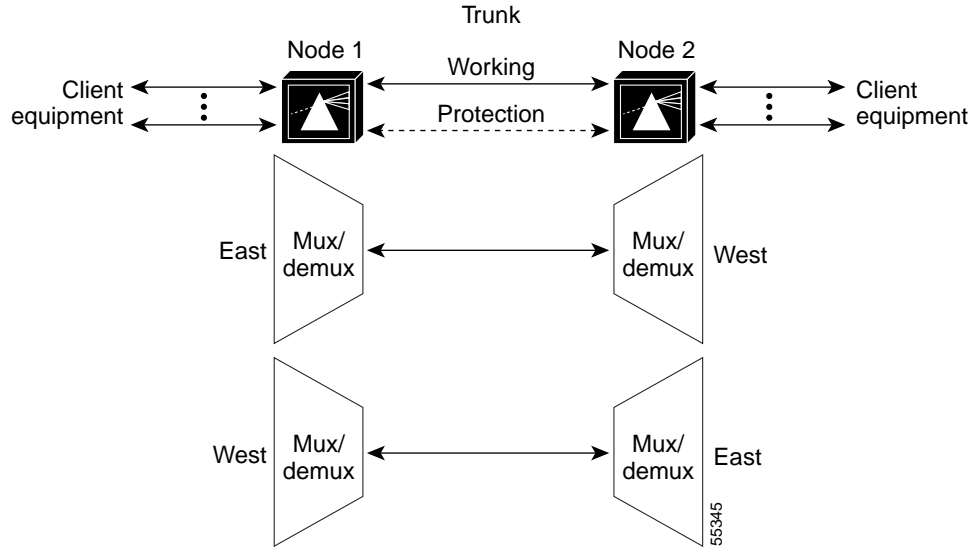

For an example configuration of a protected point-to-point topology, see the “[Splitter Protected 32-Channel Point-to-Point Configuration](#)” section on page 5-4 and the “[Line Card Protected 16-Channel Point-to-Point Configuration](#)” section on page 5-6.

Bus Topology

In a bus topology, sometimes called *linear add/drop*, there is an intermediate add/drop node between the two terminal nodes. Figure 2-7 shows an example of this type of topology. Bands A and B (channels 1–4 and 5–8) terminate at node 1. Band B is dropped at node 2, which passes band A through. To support this configuration, the add/drop node must have add/drop mux/demux modules in both slots 0 and 1 for west and east directions.

Figure 2-7 Bus Topology

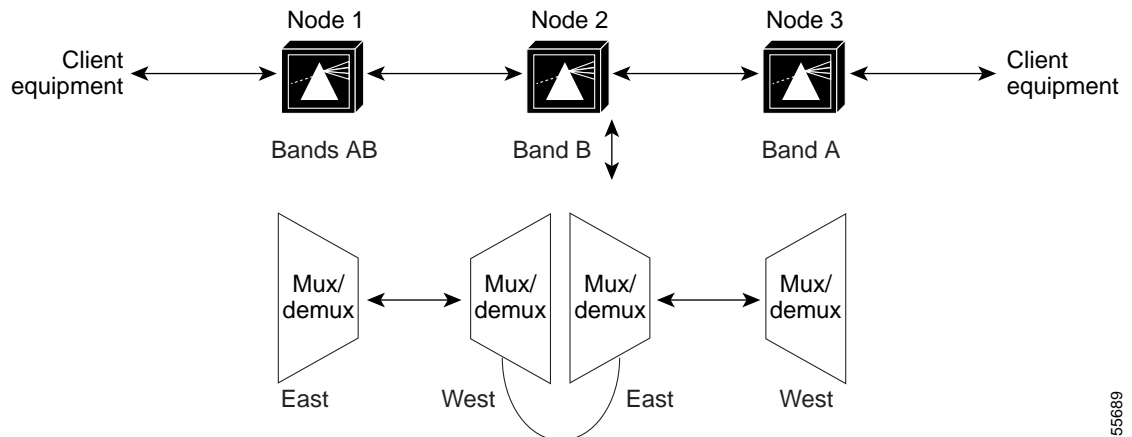

This type of topology offers limited protection. In this example a failure on the link between node 2 and node 3 would result in the loss of band A, but band B would remain operational between nodes 1 and 2. A failure on the link between node 1 and node 2 would result in a loss of both bands.



Note

If protection for all bands is required in a topology such as this, where there is a single add/drop node between two terminal nodes, a ring can be used.

Ring Topologies

In a ring topology, client equipment is attached to three or more Cisco ONS 15540 systems, which are interconnected in a closed loop. Channels are dropped and added at two nodes on the ring. Rings have many applications, including providing extended access to SANs (storage area networks) and upgrading existing SONET rings. In the cases where SONET rings are at capacity, the SONET equipment can be moved off the ring and connected to the Cisco ONS 15540 systems. Then the SONET client signals are multiplexed and transported over the DWDM link, thus increasing the capacity of existing fiber.

Hubbed Ring

A hubbed ring is composed of a hub node and two or more add/drop or satellite nodes. All channels on the ring originate and terminate on the hub node. At the add/drop node certain channels are terminated (dropped and added back) while the channels that are not being dropped (express channels) are passed through optically, without being electrically regenerated.

Channels are dropped and added in bands. [Figure 2-8](#) shows a four-node hubbed ring in which bands ABC terminate on node 1. Nodes 1 and 2 communicate using band A, nodes 1 and 3 communicate using band B, and nodes 1 and 4 communicate using band C.

Figure 2-8 Hubbed Ring Topology Example

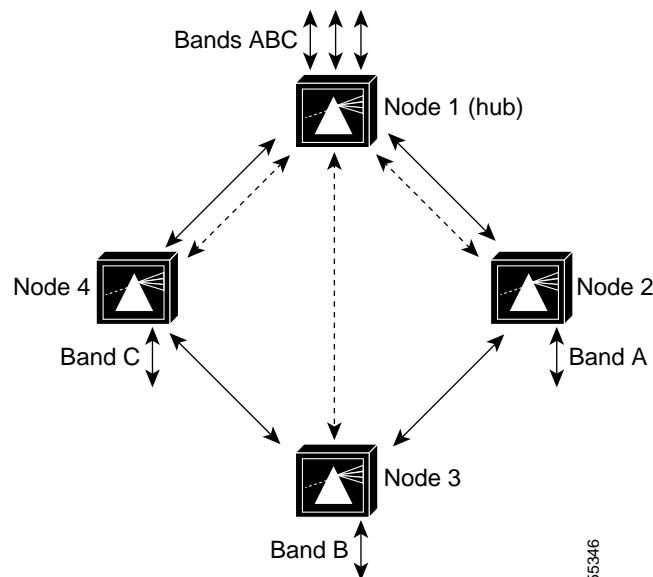

For example configurations of hubbed ring topologies, see the [“Hubbed Ring Topologies”](#) section on [page 5-11](#).

Meshed Ring

A meshed ring is a physical ring that has the logical characteristics of a mesh. While traffic travels on a physical ring, the logical connections between individual nodes are meshed. An example of this type of configuration, which is sometimes called a *logical mesh*, is shown in Figure 2-9. Nodes 1 and 2 communicate using band A, nodes 1 and 3 communicate using band B, and nodes 1 and 4 communicate using band C, as in the previous example (Figure 2-8). In this example, however, the fact that nodes 3 and 4 communicate independently using band D makes it a meshed ring.

Figure 2-9 Meshed Ring Topology Example

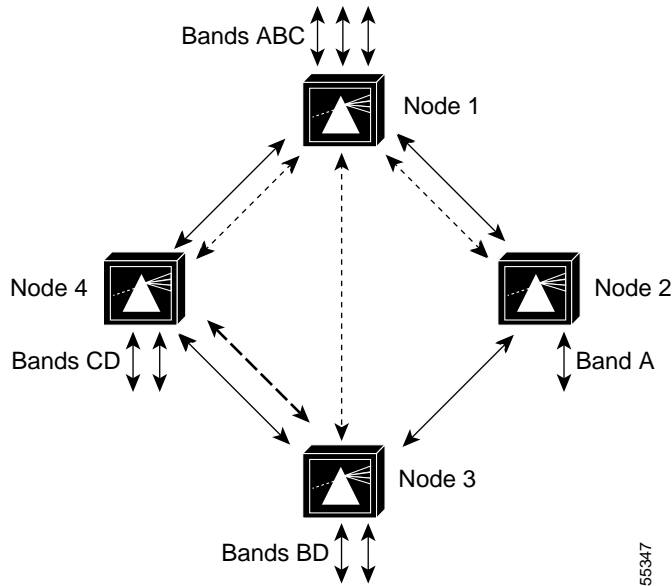

For example configurations of meshed ring topologies, see the “[Meshed Ring Topologies](#)” section on page 5-33.

Protection in Ring Topologies

Protection in the Cisco ONS 15540 is supported using per-channel unidirectional path switching or bidirectional path switching. Protection mechanisms are implemented in both the hardware and the APS software.

Unidirectional Path Switching

Unidirectional path switching is based on a variant of the SONET UPSR (Unidirectional Path Switched Ring). For each channel on a ring, traffic is transmitted in both directions from each node, using one of the fiber pair for each direction; on each node, traffic is received from one direction. In the event of a failure of the receive signal at a node, the node switches over to receive the signal from the other direction. Switching decisions are made on a node-by-node basis, and some channels can be received from one direction while others are received from the other direction. Protection in rings can be implemented on the Cisco ONS 15540 using either a splitter or y-cable configuration.

Figure 2-10 shows a three-node hubbed ring. In the example, node 1 is sending traffic from both east and west mux/demux interfaces, but is actively receiving only on the west side.

Figure 2-10 Per-Channel Unidirectional Path Switching in Normal State

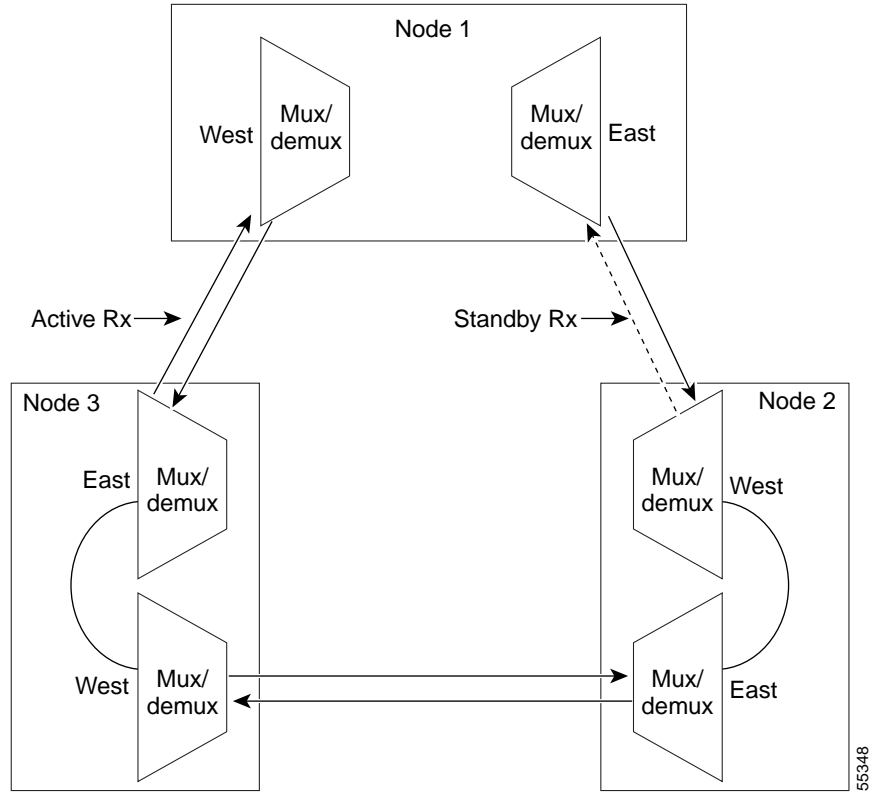
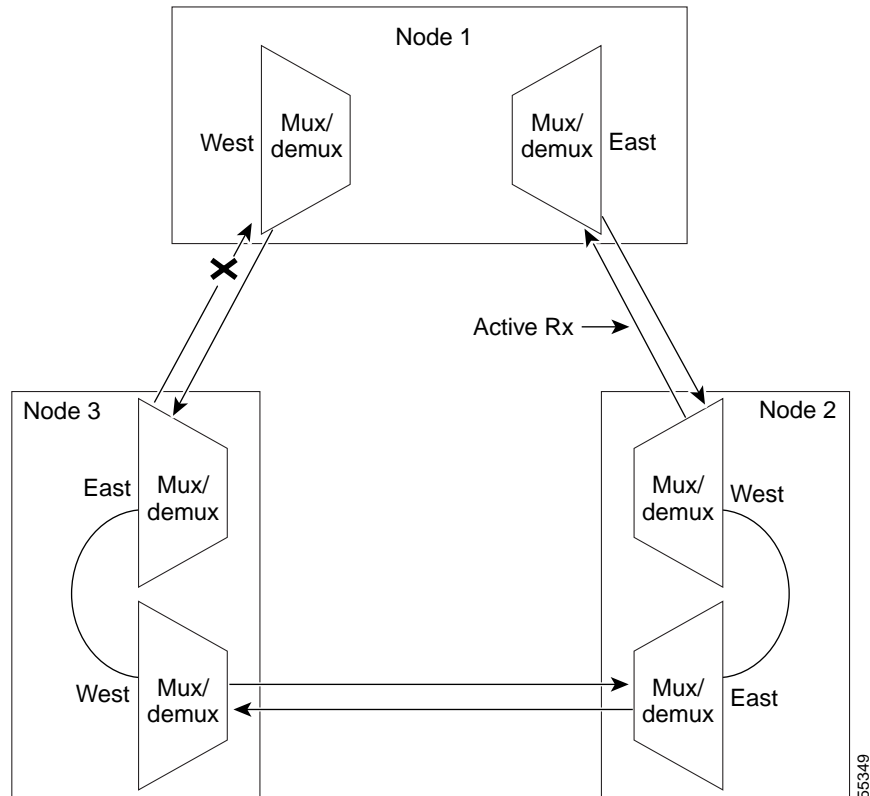

Figure 2-11 shows a failure on the receive signal from node 3 to node 1. In this event, node 1 switches to the receive signal on its east mux/demux interface for the failed channel(s). Assuming that the failure is only in one direction between node 1 and node 3, node 3 would not be required to switch receive directions. If, however, both directions were affected (for example, a fiber cut) and node 3 had been receiving on its east side, it would switch to the west side for its active receive signal.

Figure 2-11 Per-Channel Unidirectional Path Switching after Protection Switch



Bidirectional Path Switching

The Cisco ONS 15540 also supports bidirectional switching through the APS software. When configured for bidirectional switching, a node that detects a fault sends a signal over the OSC to the source node to also switch its receive direction. Assume, for example, that the channels configured between node 1 and node 3 in Figure 2-11 were communicating over the link that fails. When node 1 switches to receive those channels from the east side (over node 2), node 3 would also switch to receive those channels from its west side. This ensures that the distance between the two nodes remains the same for those channels. This option is supports protocols that are distance sensitive.



Shelf Configuration Rules

The design of the Cisco ONS 15540 requires that a set of rules be followed during physical configuration of the shelf. These rules, along with examples, are provided in this chapter. This chapter contains the following major sections:

- [Per Shelf Rules Using Add/Drop Mux/Demux Modules, page 3-1](#)
- [Per Shelf Rules Using Terminal Mux/Demux Modules, page 3-10](#)
- [Per Shelf Rules for 2.5-Gbps Line Card Motherboards, page 3-12](#)
- [General Rules for Ring Topologies, page 3-13](#)



Note

Applying the shelf configuration rules requires an understanding of the Cisco ONS 15540 system components and protection schemes, including the optical backplane. See especially the “[System Components](#)” section on page 1-3 and the “[Protection Against Fiber and System Failures](#)” section on page 2-1.

Per Shelf Rules Using Add/Drop Mux/Demux Modules

In an unprotected configuration, a shelf can have only one add/drop mux/demux module with a given channel band transmitting and receiving in a given direction (either west or east). [Table 3-1](#) lists the conflicting bands 4-channel and 8-channel add/drop mux/demux modules. If an add/drop mux/demux module that supports a band in a particular row of column 1 in [Table 3-1](#) is installed on a shelf in an unprotected configuration, that shelf cannot also have a module that supports any of the conflicting bands in column 2 transmitting and receiving in the same direction. For example, modules for band A and band AB both cannot transmit to and receive from the west.

Table 3-1 *Conflicting Bands for Add/Drop Mux/Demux Module*

Band	Conflicting Bands
A	A with OSC, AB, AB with OSC
B	B with OSC, AB, AB with OSC
C	C with OSC, CD, CD with OSC
D	D with OSC, CD, CD with OSC
E	E with OSC, EF, EF with OSC
F	F with OSC, EF, EF with OSC

Table 3-1 *Conflicting Bands for Add/Drop Mux/Demux Module (continued)*

Band	Conflicting Bands
G	G with OSC, GH, GH with OSC
H	H with OSC, GH, GH with OSC
A with OSC	A, AB, any band with OSC
B with OSC	B, AB, any band with OSC
C with OSC	C, CD, any band with OSC
D with OSC	D, CD, any band with OSC
E with OSC	E, EF, any band with OSC
F with OSC	F, EF, any band with OSC
G with OSC	G, GH, any band with OSC
H with OSC	H, GH, any band with OSC
AB	A, A with OSC, B, B with OSC, AB, AB with OSC
CD	C, C with OSC, D, D with OSC, CD, CD with OSC
EF	E, E with OSC, F, F with OSC, EF, EF with OSC
GH	G, G with OSC, H, H with OSC, GH, GH with OSC
AB with OSC	A, B, AB, any band with OSC
CD with OSC	C, D, CD, any band with OSC
EF with OSC	E, F, EF, any band with OSC
GH with OSC	G, H, GH, any band with OSC

Add/Drop Mux/Demux Modules with Splitter Protection

When configuring channels to use splitter protection, add/drop mux/demux modules with the same channels must be present in the same positions in both slots 0 and 1. During migration, one of the modules might not be present, or one of the modules might contain only a subset of the channels present on the other module. The latter is only possible if the add/drop mux/demux modules map the common channels to the same optical backplane traces.

[Figure 3-1](#) shows an example shelf configuration for splitter protection with add/drop mux/demux modules for band AB in positions 0/0 and 1/0.

Figure 3-1 Example Installation of Add/Drop Mux/Demux Modules with Splitter Protection

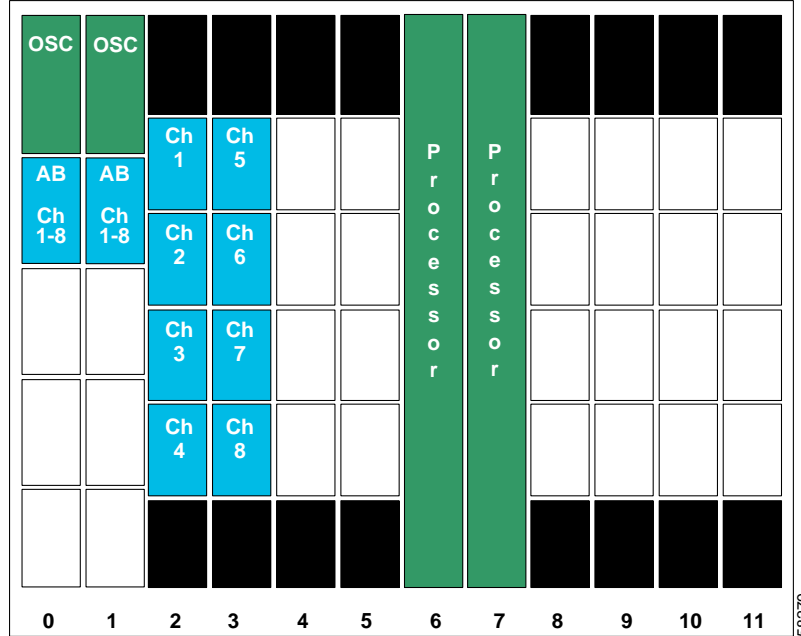

Add/Drop Mux/Demux Modules Without Splitter Protection

If not using splitter protection, when an add/drop mux/demux module is present in slot 0, there must be no mux/demux module in the corresponding position in slot 1 that picks up the same channels. Conversely, when an add/drop mux/demux module is present in slot 1, there must be no mux/demux module in the corresponding position in slot 0 that picks up the same channels.



Note

These rules apply to unprotected or line card protected (y-cable or client) configurations.

4-Channel Mux/Demux Modules Without Splitter Protection

The rules for the 4-channel mux/demux modules are as follows (see [Table 3-2](#)):

- If a 4-channel mux/demux module from group X (the lower 4 channels of an 8-channel range) is present in slot 0, then the corresponding position in slot 1 must either be empty, or have a 4-channel mux/demux module from group Y (the upper 4 channels of an 8-channel range).
- If a 4-channel mux/demux module from group Y is present in slot 0, then the corresponding position in slot 1 must either be empty, or have a 4-channel mux/demux module from group X.
- If a 4-channel mux/demux module from group X is present in slot 1, then the corresponding position in slot 0 must either be empty, or have a 4-channel mux/demux module from group Y.
- If a 4-channel mux/demux module from group Y is present in slot 1, then the corresponding position in slot 0 must either be empty, or have a 4-channel mux/demux module from group X.

Table 3-2 Band Pairings for 4-Channel Mux/Demux Modules Without Splitter Protection

Group X 4-Channel Mux/Demux Module Band	Group Y 4-Channel Mux/Demux Module Band
A	B
A with OSC	B with OSC
C	D
C with OSC	D with OSC
E	F
E with OSC	F with OSC
G	H
G with OSC	H with OSC

Figure 3-2 shows an example shelf configuration for line card protection with add/drop mux/demux modules for band A in positions 0/0 and 1/1.

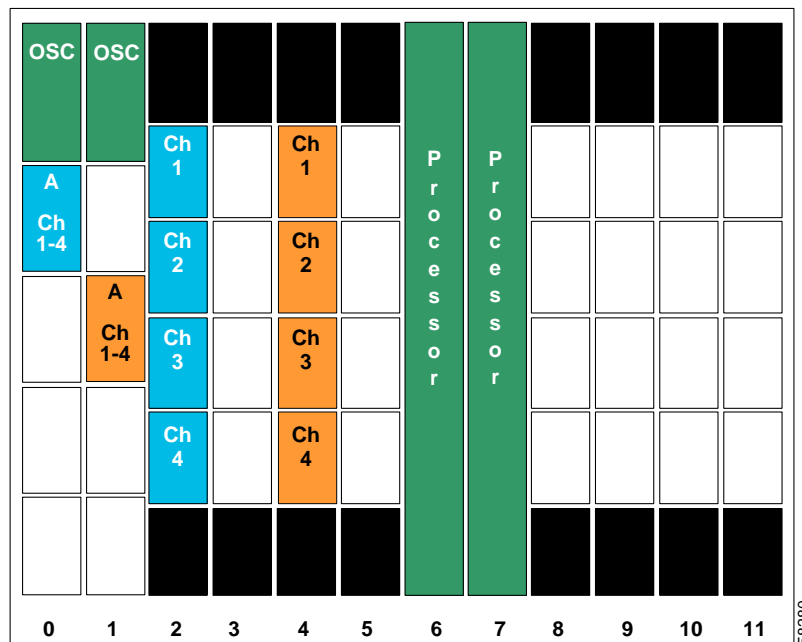
Figure 3-2 Example Installation of Add/Drop Mux/Demux Modules with Line Card Protection

8-Channel Mux/Demux Modules Without Splitter Protection

The rules for 8-channel mux/demux modules are as follows:

- If an 8-channel mux/demux module is present in slot 0, the corresponding position in slot 1 must be empty.
- If an 8-channel mux/demux module is present in slot 1, the corresponding position in slot 0 must be empty.

Transponder Module Placement When Using Add/Drop Mux/Demux Modules

The fixed optical backplane maps the transponder (or ITU direct insertion module) subslots to connectors at specific positions on the mux/demux motherboards (see [Figure 2-2 on page 2-4](#)). Thus, for all the channels present on the optical mux/demux modules, transponders must be present in the corresponding transponder subslots. Specifically, for all channels present on the add/drop mux/demux modules in positions 0/x or 1/x in [Table 3-3](#), transponder modules should be present in slots $y, y+1$.

Table 3-3 Add/Drop Mux/Demux Module to Transponder Slot Mapping

Mux/Demux Module Slot/Subslot 0/x or 1/x	Transponder Slots $y, y+1$
0	2, 3
1	4, 5
2	8, 9
3	10, 11

For example, if there is an add/drop mux/demux module in position 0/2 or 1/2, you must use slots 8 and 9 for the transponder modules with the corresponding channels.



Note

When using y-cable protection, ensure that both transponder modules are of the same type (single-mode, multimode, or extended range) for a given client signal. For example, if client signal A connects by a y-cable to transponders in positions 2/0 and 8/0, then both of those transponder must either be single-mode, multimode, or extended range. Also, if using extended range transponder modules, the transceivers must be the same type.

Transponder Modules with 4-Channel Mux/Demux Modules

For the 4-channel mux/demux modules from group X in [Table 3-2](#), transponder modules supporting channels $w+0$ to $w+3$ must be present in the positions shown in [Table 3-4](#), where w is the first channel in the 4-channel band and y is the first transponder slot number in column 2 of [Table 3-3](#).

Table 3-4 Transponder Module Placement for Lower Channels When Using 4-Channel Mux/Demux Modules

Channel	Transponder Slot/Subslot
$w+0$	$y/0$
$w+1$	$y/1$
$w+2$	$y/2$
$w+3$	$y/3$

For example, if a band A module (channels 1–4) is present in mux/demux subslot 0, the four transponder modules supporting those channels must be installed in slot/subslots 2/0 through 2/3.

Figure 3-3 provides a graphic representation of the rule in Table 3-4. The figure shows the four possible arrangements of transponder modules and add/drop mux/demux modules that can support the lower 4 channels (bands A, C, E, G) of an 8-channel range. These examples assume splitter protection; if the east or west line card motherboard were used, one of the mux/demux slots would remain empty.

Figure 3-3 Transponder Placement with Add/Drop Mux/Demux Modules for Bands A, C, E, G

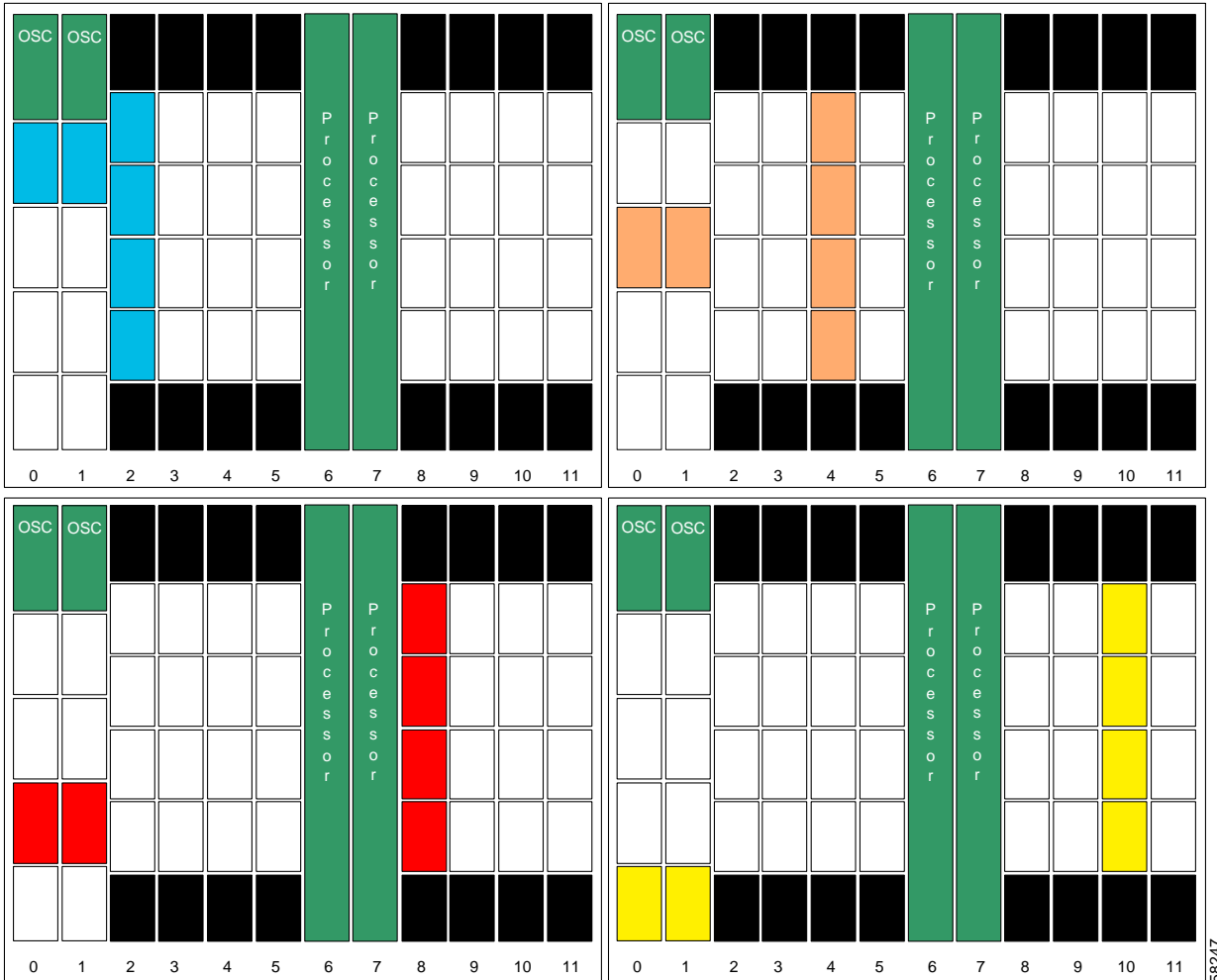

For the 4-channel mux/demux modules from group Y in Table 3-2, transponder modules supporting channels $w+0$ to $w+3$ must be present in the positions shown in Table 3-5, where w is the first channel in the 4-channel band and $y+1$ is the second transponder slot number in column 2 of Table 3-3.

Table 3-5 Transponder Module Placement for Upper Channels When Using 4-Channel Mux/Demux Modules

Channel	Transponder Slot/Subslot
$w+0$	$y+1/0$
$w+1$	$y+1/1$
$w+2$	$y+1/2$
$w+3$	$y+1/3$

In other words, if you think of the 32 channels as comprising four ranges of eight channels, you must install the transponder modules for the first four channels of a range of eight in either slot 2, 4, 8, or 10, and the transponder modules for the last four channels of the range in the next higher adjoining slot. The transponder modules must be installed in ascending order based on channel number.

For example, if a band B module (channels 5–8) is present in mux/demux subslot 0, the four transponder modules supporting those channels must be installed in slot/subslots 3/0 through 3/3.

Figure 3-4 provides a graphic representation of the rule in Table 3-5. The figure shows the four possible arrangements of transponder modules and add/drop mux/demux modules that can support the upper 4 channels (bands B, D, F, and H) of an 8-channel range. These examples assume splitter protection; if the east or west line card motherboard were used, one of the mux/demux slots would remain empty.

Figure 3-4 Transponder Placement with Add/Drop Mux/Demux Modules for Bands B, D, F, H

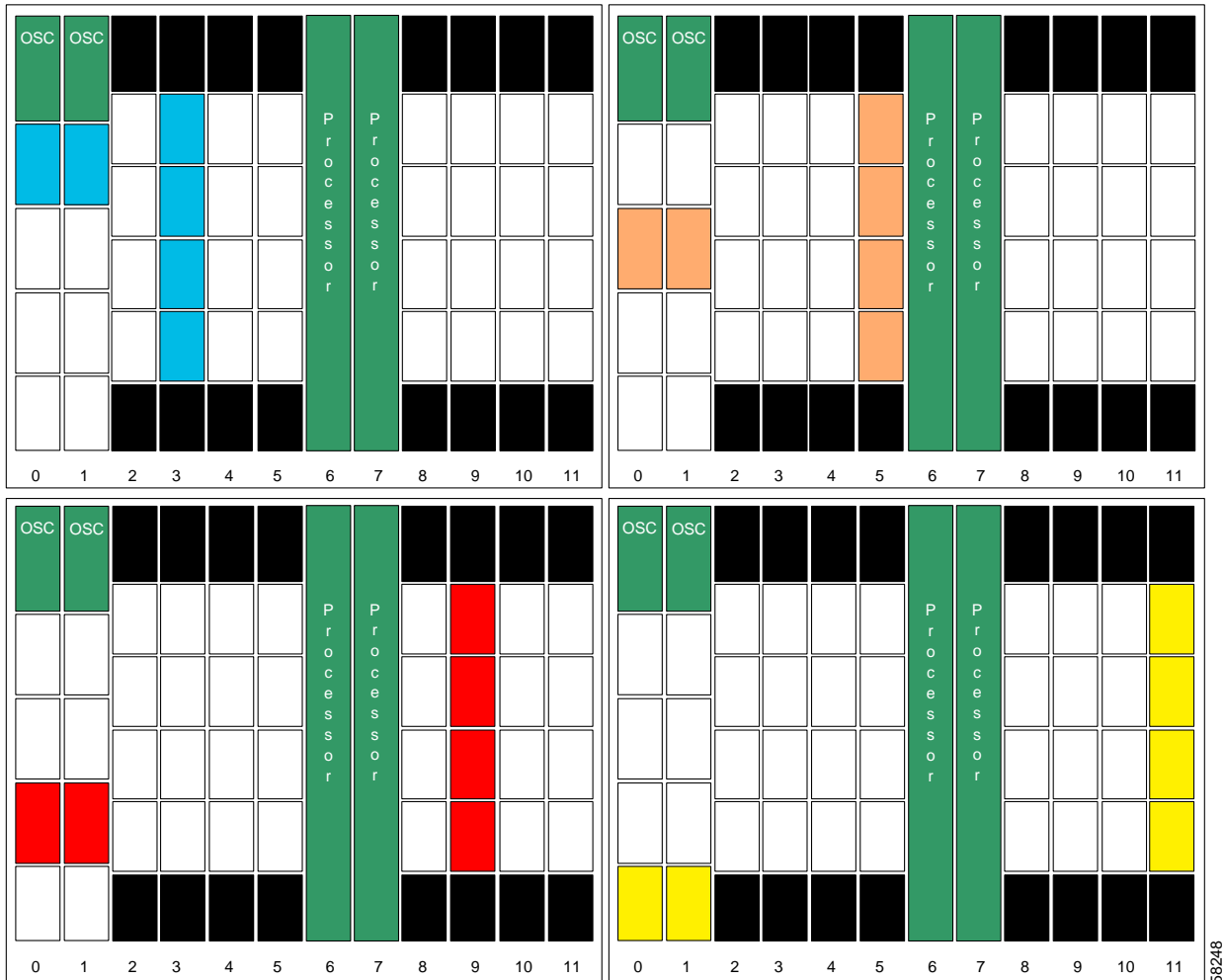

Transponder Modules with 8-Channel Mux/Demux Modules

For 8-channel mux/demux modules containing channels $w+0$ to $w+7$, the transponder modules supporting these channels must be present in the positions shown in [Table 3-6](#), where w is the first channel in an 8-channel band and y is the first transponder slot number in column 2 of [Table 3-3](#).

Table 3-6 Transponder Module Placement When Using 8-Channel Mux/Demux Modules

Channel	Transponder Slot/Subslot
$w+0$	$y/0$
$w+1$	$y/1$
$w+2$	$y/2$
$w+3$	$y/3$
$w+4$	$y+1/0$
$w+5$	$y+1/1$
$w+6$	$y+1/2$
$w+7$	$y+1/3$

For example, if a band AB module (channels 1–8) is present in mux/demux subslot 0, the four transponder modules supporting channels 1–4 must be installed in slot/subslots 2/0 through 2/3, and the four transponder modules supporting channels 5–8 must be installed in slot/subslots 3/0 through 3/3.

[Figure 3-5](#) provides a graphic representation of the rule in [Table 3-6](#). The figure shows the four possible arrangements of transponder modules and add/drop mux/demux modules that can support an 8-channel range (bands AB, CD, EF, GH). These examples assume splitter protection; if the east or west line card motherboard were used, one of the mux/demux slots would remain empty.

Figure 3-5 Transponder Placement with Add/Drop Mux/Demux Modules for Bands AB, CD, EF, GH

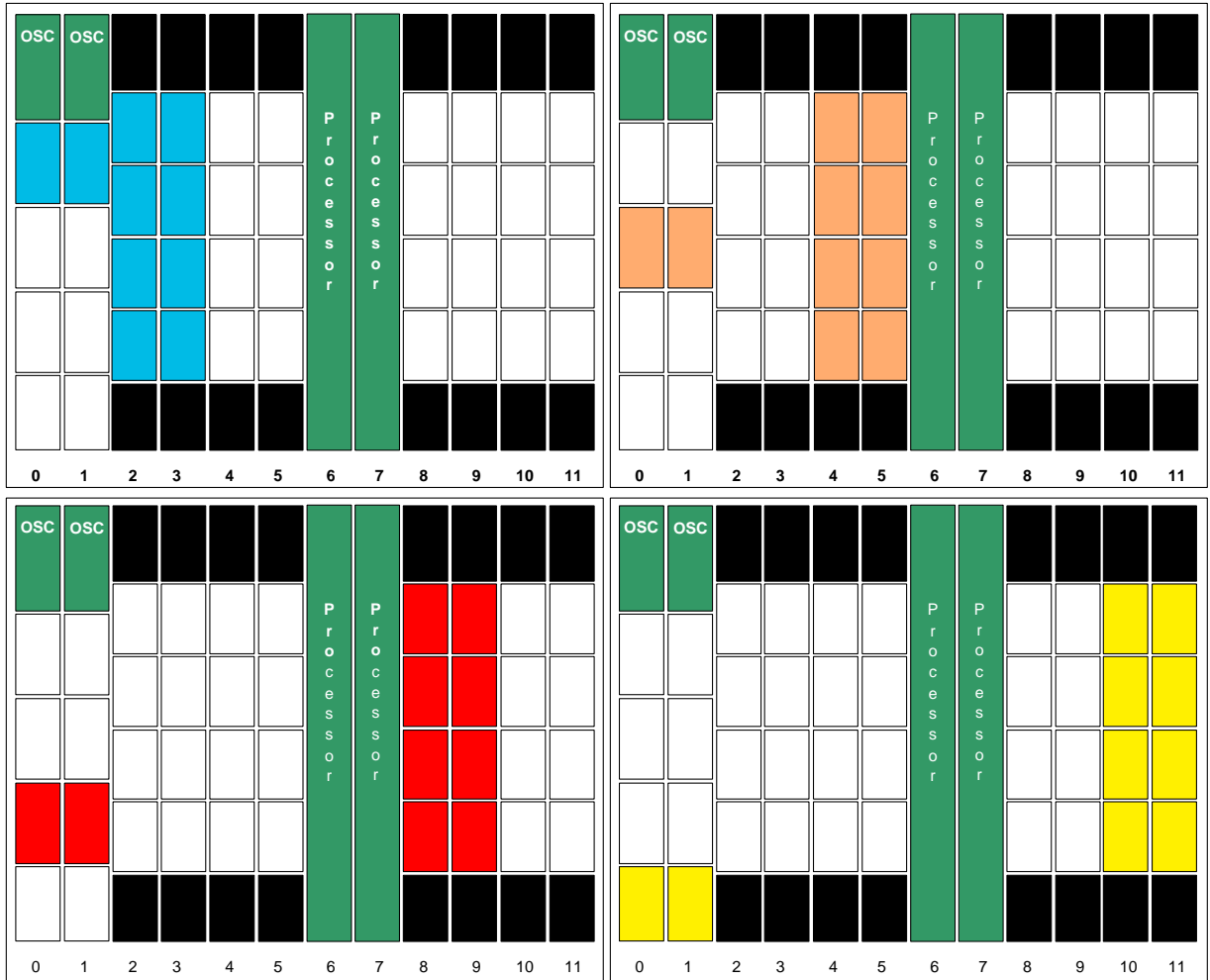

58249

Cabling of Add/Drop Mux/Demux Modules

The following rules apply when cabling the 4- and 8-channel add/drop mux/demux modules:

- Use fiber optical cables with MU connectors to cable the add/drop mux/demux modules.
- Cable the OSC from the mux/demux motherboard only to the add/drop mux/demux module that connects to the trunk (east and west sides). Connect the OSC IN on the mux/demux module to OSC OUT on the mux/demux motherboard; connect the OSC OUT on the mux/demux module to OSC IN on the mux/demux motherboard.
- Connect west to east, never west to west or east to east, between nodes in a ring.
- Connect the trunk receive direction to TI (trunk interface) IN, and trunk transmit direction to TI OUT (east and west sides).
- Connect Thru OUT to TI IN, and OUT to TI IN between add/drop mux/demux modules on the same side.
- Connect Thru OUT to Thru IN between add/drop mux/demux modules on west and east sides.

For examples of add/drop mux/demux module cabling in a protected ring configuration, see [Figure 1-1 on page 1-2](#) and [Figure 1-6 on page 1-15](#).

Per Shelf Rules Using Terminal Mux/Demux Modules

There are two types of terminal (16-channel) mux/demux modules: one for band AD with OSC, and one for band EH without OSC. The band EH terminal mux/demux module can only be used in conjunction with the band AD module. The following sections describe additional rules for using the 16-channel terminal mux/demux module.

Terminal Mux/Demux Modules with Splitter Protection

When using splitter protection, terminal mux/demux modules that support the same channels should be present in the same position in both slot 0 and slot 1. During migration, it is possible that a module will not be present in one of the slots, or that one of the modules contains a subset of the channels present on the other module. The latter is only possible if the terminal mux/demux modules map the common wavelengths to the same optical backplane traces.

Terminal Mux/Demux Modules Without Splitter Protection

When splitter protection is not used, if a terminal mux/demux module is present in slot 0, the corresponding position in slot 1 must be empty, and vice versa.

Transponder Module Placement When Using Terminal Mux/Demux Modules

For all the channels present on the terminal mux/demux modules in positions 0/*x* and 1/*x*, transponder modules should be present in the slots shown in [Table 3-7](#).

Table 3-7 Terminal Mux/Demux Module to Transponder Slot Mapping

Mux/Demux Slot/Subslot 0/ <i>x</i> or 1/ <i>x</i>	Transponder Slots <i>y</i> to <i>y</i> +3
0-1	2, 3, 4, 5
2-3	8, 9, 10, 11



Note

It is possible for some transponder line cards or modules to be missing. This might happen in cases where not all 16 channels are needed, or during migration.



Note

When using *y*-cable protection, ensure that both transponder modules are of the same type (single-mode, multimode, or extended range) for a given client signal. For example, if client signal A connects by a *y*-cable to transponders in positions 2/0 and 8/0, then both of those transponder must either be single-mode, multimode, or extended range. Also, if using extended range transponder modules, the transceivers must be the same type.

For the 16-channel mux/demux modules containing channels $w+0$ to $w+15$, transponder modules supporting these channels must be present in the positions shown in [Table 3-8](#), where y is the first transponder slot number in column 2 of [Table 3-7](#).

Table 3-8 Transponder Module Placement When Using 16-Channel Mux/Demux Modules

Channel	Transponder Slot/Subslot
$w+0$	$y/0$
$w+1$	$y/1$
$w+2$	$y/2$
$w+3$	$y/3$
$w+4$	$y+1/0$
$w+5$	$y+1/1$
$w+6$	$y+1/2$
$w+7$	$y+1/3$
$w+8$	$y+2/0$
$w+9$	$y+2/1$
$w+10$	$y+2/2$
$w+11$	$y+2/3$
$w+12$	$y+3/0$
$w+13$	$y+3/1$
$w+14$	$y+3/2$
$w+15$	$y+3/3$



Note

With the 16-channel mux/demux modules, if channels 17–32 are present, channels 1–16 must also be present.

Figure 3-6 provides a graphic representation of the rule in Table 3-8. The example shows a 32-channel splitter protected shelf configuration.

Figure 3-6 Transponder Module Placement Using 16-Channel Mux/Demux Modules for Bands AD and EH

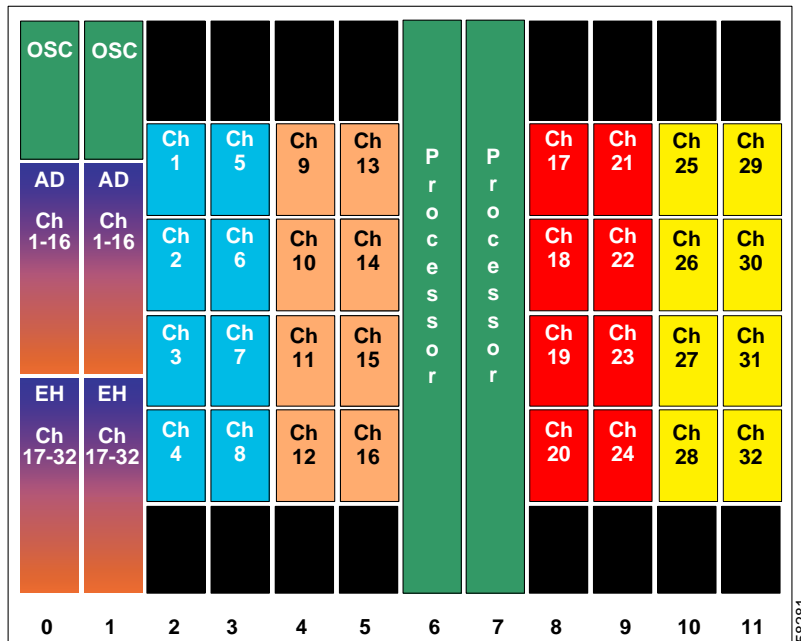

Cabling of Terminal Mux/Demux Modules

The following rules apply when cabling the 16-channel terminal mux/demux modules:

- Cable the OSC from the mux/demux motherboard to the OA and OD connectors on the band AD terminal mux/demux module. Connect OSC OUT to OA and OSC IN to OD.
- Connect the trunk receive direction to I and the trunk transmit direction to O on the band AD terminal mux/demux module.
- Connect 2AD to 2BD and 2AM to 2BM when using the band EH module with the band AD module.

Per Shelf Rules for 2.5-Gbps Line Card Motherboards

If splitter protection is used, the corresponding transponder slots must use the splitter protected line card motherboards.

If line card protection is used, the following rules apply:

- The transponder slots corresponding to the optical mux/demux modules in slot 0 should use the west line card motherboards, which are wired only to the backplane traces to slot 0. This is to avoid sending four copies of the signal as a result of duplication in the y-cable (or redundant client signals) and reduplication in the splitter on the line card motherboard. Alternatively, splitter protected line card motherboards can be used. When splitter protected line card motherboards are used, all wavepatch y/z/0 interfaces in the slot should be configured as “shutdown.”

- The transponder slots corresponding to the optical mux/demux modules in slot 1 should use the east line card motherboards, which are wired only to the backplane traces to slot 1. Alternatively, splitter motherboards can be used. When splitter protected line card motherboards are used, all wavepatch y/z/1 interfaces in the slot should be configured as “shutdown.”

**Note**

When configuring a system for line card protection, the east and west line card motherboards offer the additional advantage of having lower optical power loss.

General Rules for Ring Topologies

The following network rules apply to ring topologies:

- A channel must be present on only two nodes in the ring when using splitter protection.
- All channels added by a node on an east add/drop mux/demux modules must be dropped on a west add/drop mux/demux module of one or more other nodes on the ring. All channels added by a node on a west add/drop mux/demux module must be dropped by an east add/drop mux/demux module of one or more other nodes on the ring. This rule may be violated during migration.
- A node cannot add a channel that is already present in the same direction until it has dropped that channel.

In addition, we recommend that if there are plans to migrate from a hubbed ring to a logical mesh, the 4-channel or 8-channel add/drop mux/demux modules should be considered for deployment at the terminal node. This strategy avoids the necessity of discarding a terminal mux/demux module when migrating.



Optical Loss Budgets

The optical loss budget is an important aspect in designing networks with the Cisco ONS 15540. The optical loss budget is the ultimate limiting factor in distances between nodes in a topology. This chapter contains the following major sections:

- [About dB and dBm, page 4-1](#)
- [Overall Optical Loss Budget, page 4-2](#)
- [Optical Loss for 2.5-Gbps Line Card Motherboards, page 4-4](#)
- [Optical Loss for Optical Mux/Demux Modules, page 4-4](#)
- [Fiber Plant Testing, page 4-5](#)



Note

The optical specifications described in this chapter are only for the individual components and should not be used to characterize the entire network performance.



Note

The information in this chapter applies only to nonamplified network design.

About dB and dBm

Signal power loss or gain is never a fixed amount of power, but a portion of power, such as one-half or one-quarter. To calculate lost power along a signal path using fractional values you cannot add $1/2$ and $1/4$ to arrive at a total loss. Instead, you must multiply $1/2$ by $1/4$. This makes calculations for large networks time-consuming and difficult.

For this reason, the amount of signal loss or gain within a system, or the amount of loss or gain caused by some component in a system, is expressed using the *decibel* (dB). Decibels are logarithmic and can easily be used to calculate total loss or gain just by doing addition. Decibels also scale logarithmically. For example, a signal gain of 3 dB means that the signal doubles in power; a signal loss of 3 dB means that the signal halves in power.

Keep in mind that the decibel expresses a ratio of signal powers. This requires a reference point when expressing loss or gain in dB. For example, the statement “there is a 5 dB drop in power over the connection” is meaningful, but the statement “the signal is 5 dB at the connection” is not meaningful. When you use dB you are not expressing a measure of signal strength, but a measure of signal power loss or gain.

It is important not to confuse decibel and *decibel milliwatt* (dBm). The latter is a measure of signal power in relation to 1 mW. Thus a signal power of 0 dBm is 1 mW, a signal power of 3 dBm is 2 mW, 6 dBm is 4 mW, and so on. Conversely, -3 dBm is 0.5 mW, -6 dBm is 0.25 mW, and so on. Thus the more negative the dBm value, the closer the power level approaches zero.

Overall Optical Loss Budget

An optical signal degrades as it propagates through a network. Components such as optical mux/demux modules, fiber, fiber connectors, splitters, and switches introduce attenuation. Ultimately, the maximum allowable distance between the transmitting laser and the receiver is based upon the optical link budget that remains after subtracting the power losses experienced by the channels with the worst path as they traverse the components at each node.

Table 4-1 lists the laser transmitter power and receiver sensitivity range for the data channels and the OSC (Optical Supervisory Channel).

Table 4-1 Trunk Side Transmitter Power and Receiver Ranges

Channel	Transmit Power (dBm)		Receiver Sensitivity (dBm)	
	Minimum	Maximum	Minimum	Overload
SM transponder module and MM transponder module data channel	4	8	-28	-8
Extended range transponder module data channel	5	10	-28	-8
OSC	4	8	-19	-1.5



Note

Add the proper system-level penalty to the receive power based on your actual network topology characteristics, such as dispersion.

The goal in calculating optical loss is to ensure that the total loss does not exceed the overall optical link (or span) budget. For the Cisco ONS 15540, this is 38 dB for data channels. For example, the OSC has an optical link budget of 26 dB, which is equal to the OSC receiver sensitivity (-22 dBm) subtracted from the OSC laser launch power (4 dBm) on the mux/demux motherboard. Typically, in point-to-point topologies, the OSC optical power budget is the distance limiting factor, while in ring topologies, the data channel optical power budget is the distance limiting factor.

Calculating Optical Loss Budgets

Using the optical loss characteristics for the Cisco ONS 15540 components, you can calculate the optical loss between the transmitting laser on one node and the receiver on another node. The general rules for calculating the optical loss budget are as follows:

- The maximum power loss between the nodes cannot exceed the minimum transmitter power of the laser minus the minimum sensitivity of the receiver and network-level penalty.



Note Determine the proper network-level penalty to the receive power based on your actual network topology characteristics, such as dispersion.

- The minimum attenuation between the nodes must be greater than the maximum transmitter power of the laser minus the receiver overload value.

The following example shows how to calculate the optical loss budget for 2.5-Gbps data channels from an extended range transponder module using the values in [Table 4-1](#):

- The power loss between the transmitter laser and receiver must not exceed 33 (5 – (–28)) dB or the signal will not be detected accurately.
- At least 18 (10 – (–8)) dB of attenuation between neighboring nodes prevents receiver saturation.

To validate a network design, the optical loss must be calculated for each band of channels. This calculation must be done for both directions if protection is implemented, and for the OSC between each pair of nodes. The optical loss is calculated by summing the losses introduced by each component in the signal path.

At a minimum, any data channel path calculation must include line card transmit loss, channel add loss, fiber loss, channel drop loss, and line card receive loss (see [Figure 4-1](#)). In ring topologies, pass through losses must be considered. Losses due to external devices such as fixed attenuators and monitoring taps must also be included.

Figure 4-1 Elements of Optical Loss in a Minimal Configuration

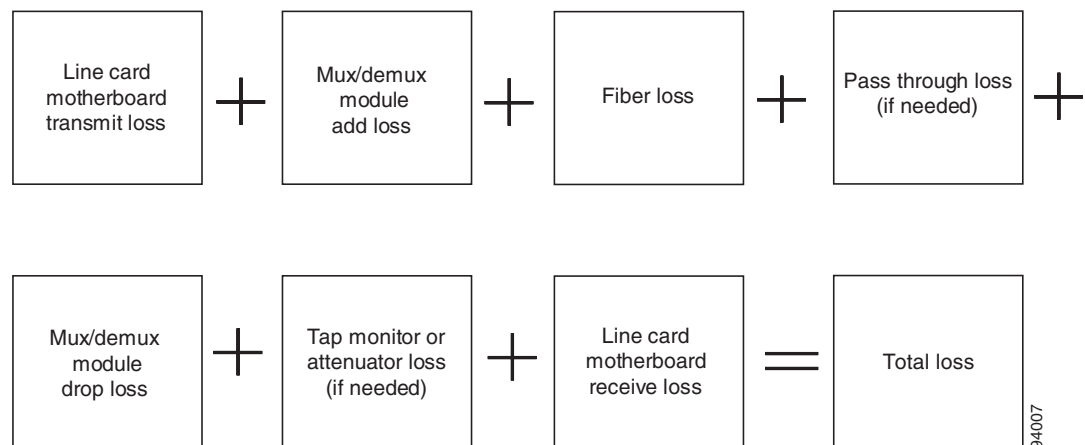

For examples of optical loss budget calculations, see the topologies described in [Chapter 5, “Example Topologies and Shelf Configurations.”](#)

Optical Loss for 2.5-Gbps Line Card Motherboards

In the transmit direction, the splitter protected line card motherboard attenuates the ITU signal emitted from its associated transponders significantly more than does the east or west motherboard. In the receive direction, the splitter protected line card motherboard attenuates the signal destined for its associated transponder significantly more than does the east or west motherboard.

Table 4-2 shows the optical loss for the splitter protected, east, and west motherboards in the transmit and receive directions.

Table 4-2 Optical Loss for 2.5-Gbps Line Card Motherboards

Line Card Motherboard Type and Direction	Loss (dB)
Splitter protected motherboard Tx	4.6
Splitter protected motherboard Rx	1.9
East motherboard Tx	1.0
East motherboard Rx	1.0
West motherboard Tx	1.0
West motherboard Rx	1.0

Optical Loss for Optical Mux/Demux Modules

Optical mux/demux modules attenuate the signals as they are multiplexed, demultiplexed, and passed through. The amount of attenuation depends upon the type of optical mux/demux module and the path the optical signal takes through the modules.

Loss for Data Channels

Table 4-3 shows the optical loss for the data channels between the 4-channel or 8-channel add/drop mux/demux modules and the transponders, and between the pass through add and drop connectors on the modules.

Table 4-3 Optical Loss for Data Channels Through the Add/Drop Mux/Demux Modules

Optical Mux/Demux Module Type	Trunk IN to Line Card Motherboard (Data Drop) in dB	Line Card Motherboard to Trunk OUT (Data Add) in dB	Trunk IN to Thru OUT (Pass Through Drop) in dB	Thru IN to Trunk OUT (Pass Through Add) in dB
4-channel with OSC	4.1	4.1	1.5	1.5
8-channel with OSC	4.8	4.8	2.0	2.0
4-channel without OSC	4.1	4.1	1.0	1.0
8-channel without OSC	4.8	4.8	1.5	1.5

Table 4-4 list the optical loss for the 16-channel terminal mux/demux modules. The third row of the table lists the connector loss and total loss when the two 16-channel modules are cascaded to support 32 channels.

Table 4-4 Optical Loss for Data Channels Through the Terminal Mux/Demux Modules

Loss Source	IN to Line Card Motherboard (Data Drop) in dB	Line Card Motherboard to OUT (Data Add) in dB
16-channel with OSC (channels 1–16)	6.5	6.5
16-channel without OSC (channels 17–32)	6.5	6.5
Total loss (32 channels)	6.5	6.5



Note

The insertion losses listed in Table 4-3 and Table 4-4 are worst case values. Take this into consideration when calculating the minimum loss budget.

Loss for the OSC

Table 4-5 shows the optical loss for the OSC between the mux/demux motherboard and the optical mux/demux modules.

Table 4-5 Optical Loss for the OSC Through the Optical Mux/Demux Modules

Optical Mux/Demux Module Type	Trunk IN to OSC Transceiver (dB)	OSC Transceiver to Trunk OUT (dB)
4-channel with OSC	2.8	2.8
8-channel with OSC	3.3	3.3
16-channel with OSC	7.1	7.1

Fiber Plant Testing

Verifying fiber characteristics to qualify the fiber in the network requires proper testing. This document describes the test requirements but not the actual procedures. After finishing the test measurements, compare the measurements with the specifications from the manufacturer, and determine whether the fiber supports your system requirements or whether changes to the network are necessary.

This test measurement data can also be used to determine whether your network can support higher bandwidth services such as 10 Gigabit Ethernet, and can help determine network requirements for dispersion compensator modules or amplifiers.

The test measurement results must be documented and will be referred to during acceptance testing of a network, as described in the *Cisco ONS 15540 ESP and Cisco ONS 15540 ESPx Optical Transport Turn-Up and Test Guide*

Fiber optic testing procedures must be performed to measure the following parameters

- Link loss (attenuation)
- optical return loss (ORL)
- polarization mode dispersion (PMD)
- chromatic dispersion

Link Loss (Attenuation)

Testing for link loss, or attenuation, verifies whether fiber spans meet loss budget requirements.

Attenuation includes intrinsic fiber loss, losses associated with connectors and splices, and bending losses due to cabling and installation. An OTDR (optical time domain reflector/reflectometer) is used when a comprehensive accounting of these losses is required. The OTDR sends a laser pulse through each fiber; both directions of the fiber are tested at 1310 nm and 1550 nm wavelengths.

OTDRs also provide information about fiber uniformity, splice characteristics, and total link distance. For the most accurate loss test measurements, an LTS (loss test set) that consists of a calibrated optical source and detector is used. However, the LTS does not provide information about the various contributions (including contributions related to splice and fiber) to the total link loss calculation.

A combination of OTDR and LTS tests is needed for accurate documentation of the fiber facilities being tested. In cases where the fiber is very old, testing loss as a function of wavelength (also called spectral attenuation) might be necessary. This is particularly important for qualifying the fiber for multiwavelength operation. Portable chromatic dispersion measurement systems often include an optional spectral attenuation measurement.

ORL

ORL is a measure of the total fraction of light reflected by the system. Splices, reflections created at optical connectors, and components can adversely affect the behavior of laser transmitters, and they all must be kept to a minimum of 24 dB or less. You can use either an OTDR or an LTS equipped with an ORL meter for ORL measurements. However, an ORL meter yields more accurate results.

PMD

PMD has essentially the same effect on the system performance as chromatic dispersion, which causes errors due to the “smearing” of the optical signal. However, PMD has a different origin from chromatic dispersion. PMD occurs when different polarization states propagate through the fiber at slightly different velocities.

PMD is defined as the time-averaged DGD (differential group delay) at the optical signal wavelength. The causes are fiber core eccentricity, ellipticity, and stresses introduced during the manufacturing process. PMD is a problem for higher bit rates (10 GE and above) and can become a limiting factor when designing optical links.

The time-variant nature of dispersion makes it more difficult to compensate for PMD effects than for chromatic dispersion. “Older” (deployed) fiber may have significant PMD—many times higher than the 0.5 ps/° km specification seen on most new fiber. Accurate measurements of PMD are very important

to guarantee operation at 10 Gbps. Portable PMD measuring instruments have recently become an essential part of a comprehensive suite of tests for new and installed fiber. Because many fibers in a cable are typically measured for PMD, instruments with fast measurement times are highly desirable.

Chromatic Dispersion

Chromatic dispersion testing is performed to verify that measurements meet your dispersion budget.

Chromatic dispersion is the most common form of dispersion found in single-mode fiber. Temporal in nature, chromatic dispersion is related only to the wavelength of the optical signal. For a given fiber type and wavelength, the spectral line width of the transmitter and its bit rate determine the chromatic dispersion tolerance of a system.

Portable chromatic dispersion measurement instruments are essential for testing the chromatic dispersion characteristics of installed fiber.



Example Topologies and Shelf Configurations

The requirements of a particular topology determine what components must be used and how they are interconnected. This chapter provides examples of shelf configurations, optical power budget calculations, and optical mux/demux module cabling specific to each of the main types of topologies supported by the Cisco ONS 15540. This chapter contains the following major sections:

- [Point-to-Point Topologies, page 5-1](#)
- [Hubbed Ring Topologies, page 5-11](#)
- [Meshed Ring Topologies, page 5-33](#)
- [Meshed Ring Topologies with Unprotected Channels, page 5-52](#)

Point-to-Point Topologies

The following criteria should be used in determining the equipment needed for a point-to-point topology:

- Number of channels at deployment and in the future
- Distance between nodes
- Potential topology changes in the future (such as migration to ring)
- Presence of OSC

There are many optical mux/demux module combinations that can satisfy the requirements of a network design. For example, a shelf can support 32 channels using eight 4-channel mux/demux modules, four 8-channel mux/demux modules, or two 16-channel mux/demux modules. However, certain configurations can prove costly as network requirements change.

The 16-channel mux/demux modules are ideally suited for a point-to-point topology. They impose less optical link loss than cascading the 4-channel and 8-channel modules, thereby maximizing the distance between nodes. Price per channel is also less if the current or future channel requirement is near 16 or 32. However, if future plans include migrating to a ring environment, the 16-channel mux/demux module is not ideal. If, for example, a point-to-point topology using 16-channel mux/demux modules at each end were migrated to a hubbed ring, the node that became an add/drop node could not use the 16-channel module (though the hub node could use that module). If the migration were to a meshed ring, neither node could use the 16-channel module.

Unprotected 32-Channel Point-to-Point Configuration

Figure 5-1 shows the optical power loss for each of the components traversed by data channels 17–32, which have the greatest amount of loss, and for the OSC. This configuration uses the east or west line card motherboards.

Figure 5-1 Optical Power Budget for Unprotected Point-to-Point Topology

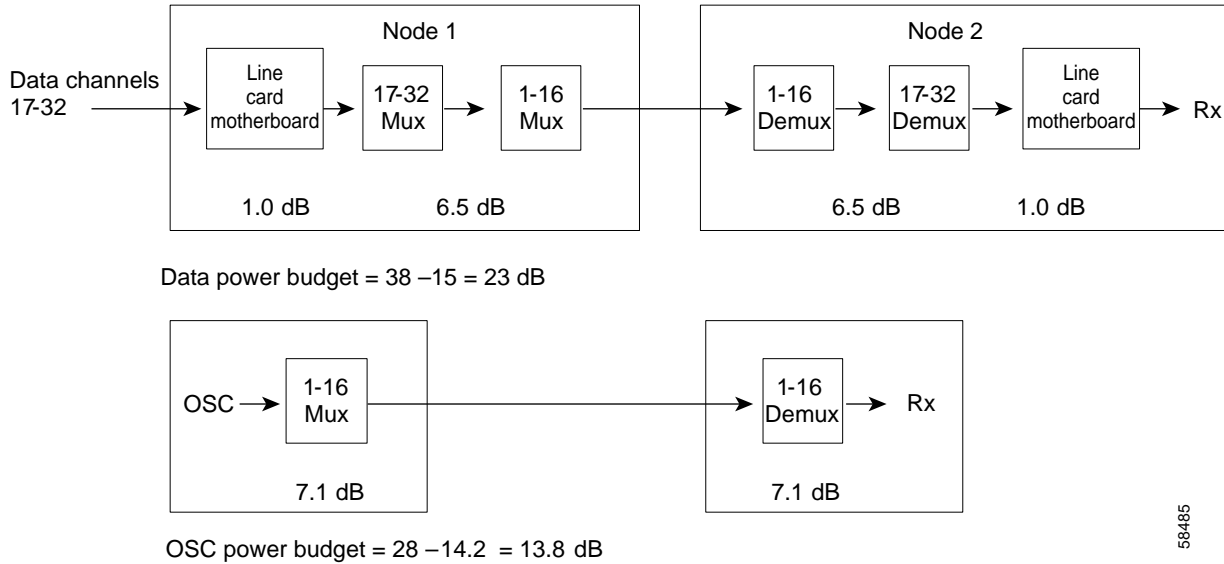

In an unprotected point-to-point topology, the Cisco ONS 15540 can support up to 32 unprotected channels on a single fiber pair.

Figure 5-2 shows how the shelf for each node is populated to support a 32-channel unprotected configuration using two 16-channel mux/demux modules. Since those modules are installed in the west mux/demux motherboard (slot 0), the line card motherboards are all west motherboards.

Figure 5-2 Shelf Configuration for Unprotected 32-Channel Point-to-Point Topology

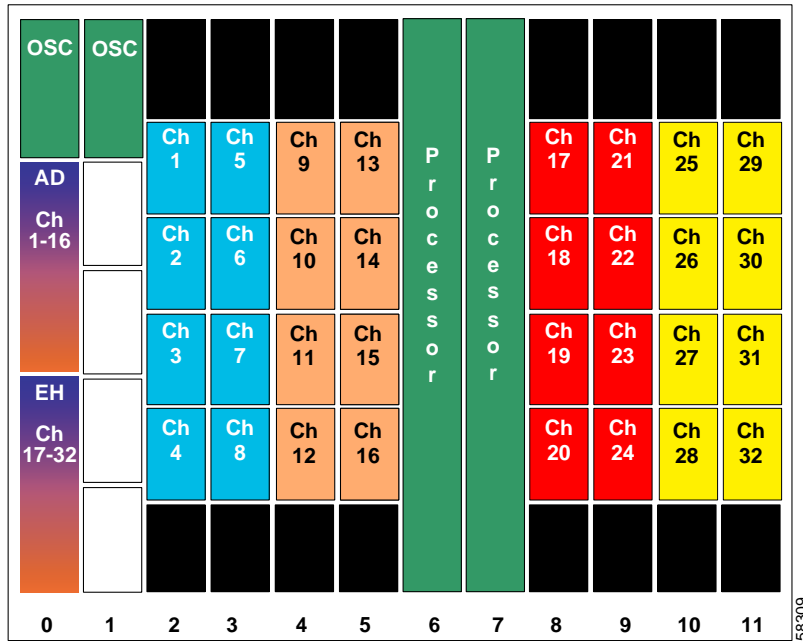

56309

Figure 5-3 shows how the terminal mux/demux modules are cabled for the 32-channel unprotected point-to-point configuration.

Figure 5-3 Terminal Mux/Demux Module Cabling with OSC for Unprotected 32-Channel Point-to-Point Topology

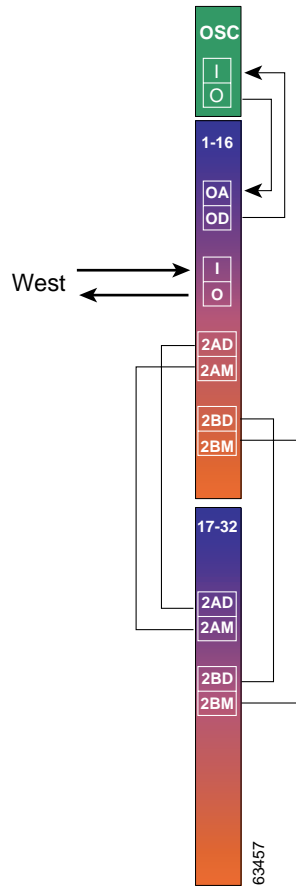

Splitter Protected 32-Channel Point-to-Point Configuration

In a splitter protected point-to-point topology, the Cisco ONS 15540 can support up to 32 protected channels on two fiber pairs.

Figure 5-4 shows the optical power loss for each of the components traversed by data channels 17–32, which have the greatest amount of loss, and for the OSC. This configuration uses the splitter protected line card motherboards.

Figure 5-4 Optical Power Budget for Splitter Protected Point-to-Point Topology

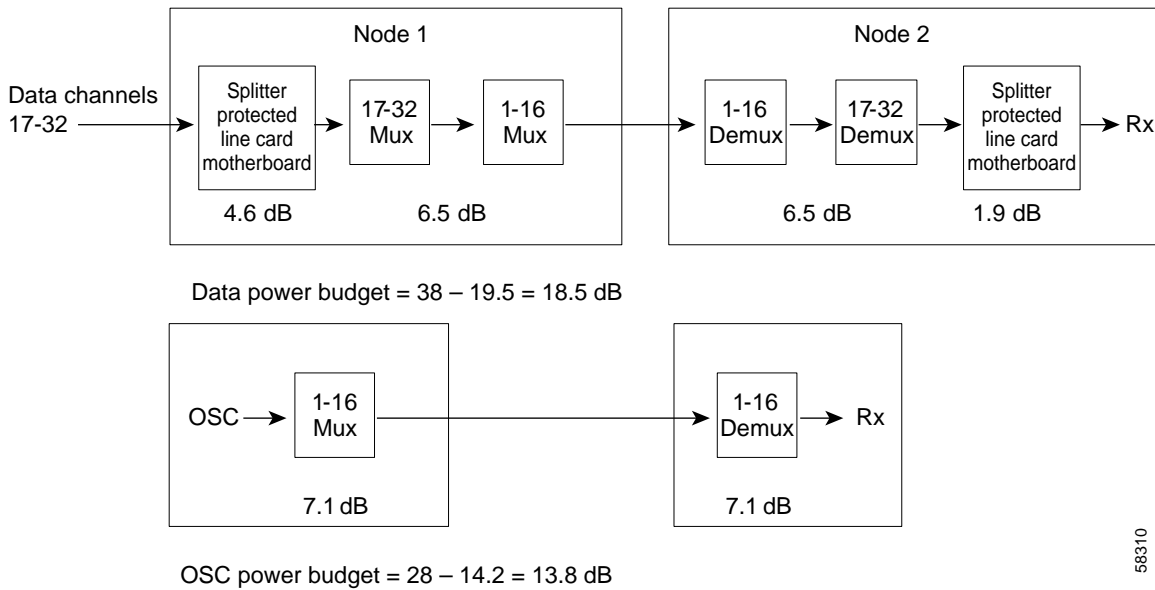

58310

Figure 5-5 shows the shelf configuration for both nodes in a 32-channel splitter protected point-to-point topology. For splitter protection, the splitter protected line card motherboards are used, along with terminal mux/demux modules in both west and east mux/demux slots.

Figure 5-5 Shelf Configuration for Splitter Protected 32-Channel Point-to-Point Topology

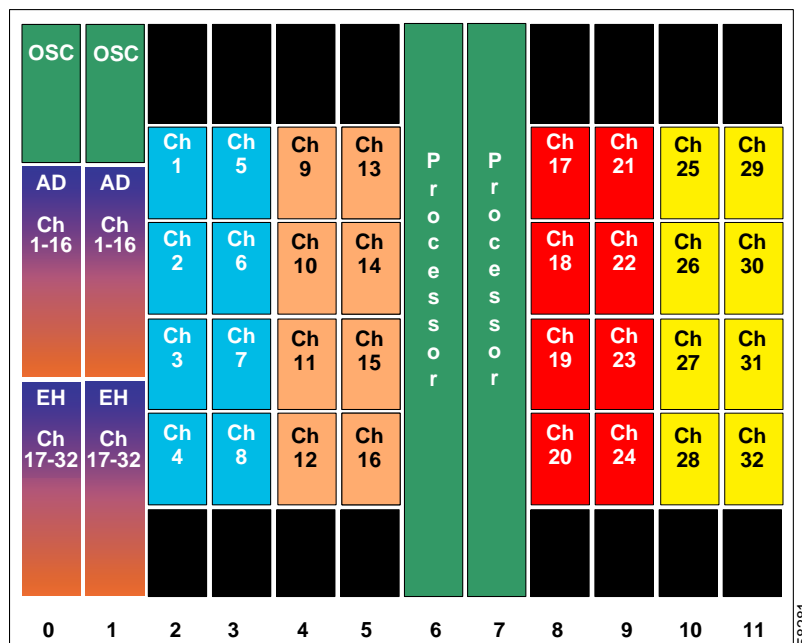

58281

Figure 5-6 shows how the terminal mux/demux modules are cabled for the 32-channel splitter protected point-to-point configuration.

Figure 5-6 Terminal Mux/Demux Module Cabling with OSC for Splitter Protected 32-Channel Point-to-Point Topology

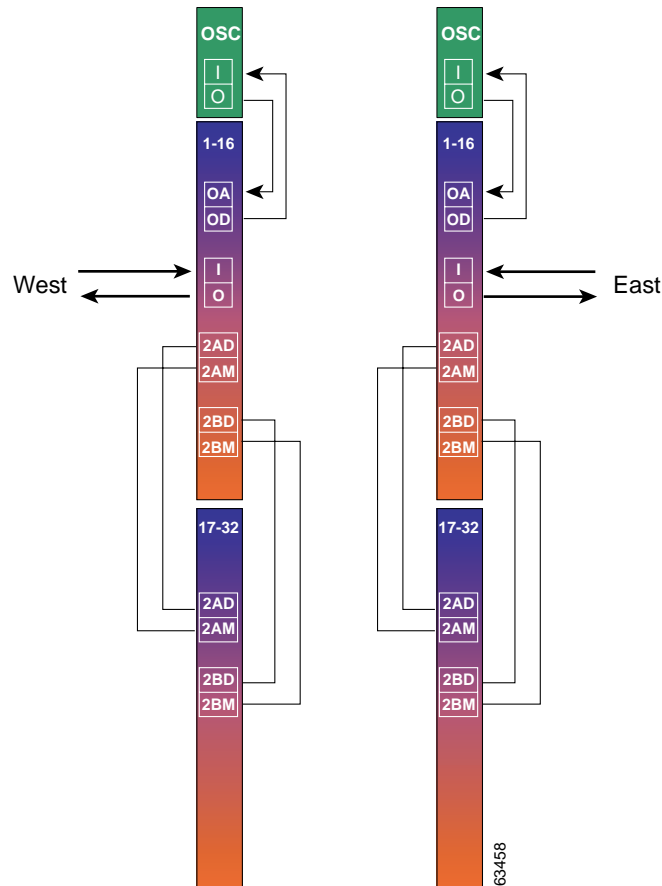

Line Card Protected 16-Channel Point-to-Point Configuration

In a line card protected point-to-point topology, a single Cisco ONS 15540 shelf can support up to 16 protected channels on two fiber pairs.

Figure 5-7 shows the optical power loss for each of the components traversed by the 16 data channels and the OSC, along with the resulting power budget. This configuration uses the east and west line card motherboards.

Figure 5-7 Optical Power Budget for Line Card Protected 16-Channel Point-to-Point Topology

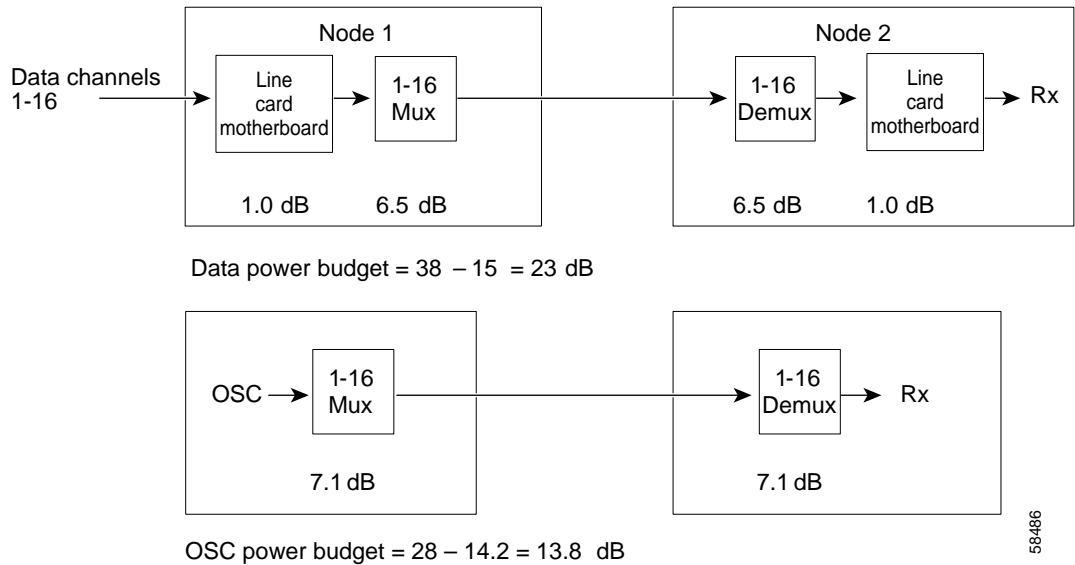

Figure 5-8 shows the shelf configuration for both nodes in a 16-channel line card protected point-to-point topology. For line card protection, the west line card motherboards are used in slots 2–5 (corresponding to the terminal mux/demux module in slot 0), and the east line card motherboards are used in slots 8–11 (corresponding to the terminal mux/demux module in slot 1).

Figure 5-8 Shelf Configuration for Line Card Protected 16-Channel Point-to-Point Topology

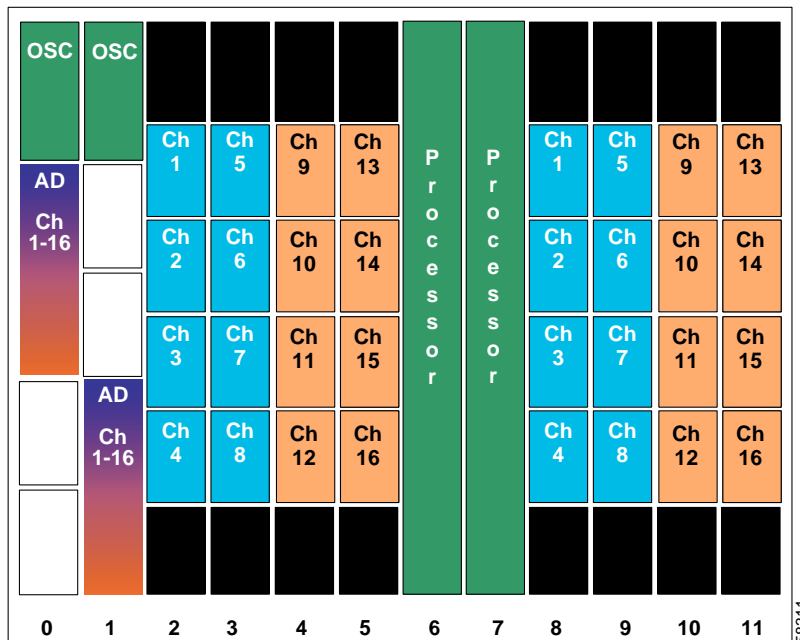
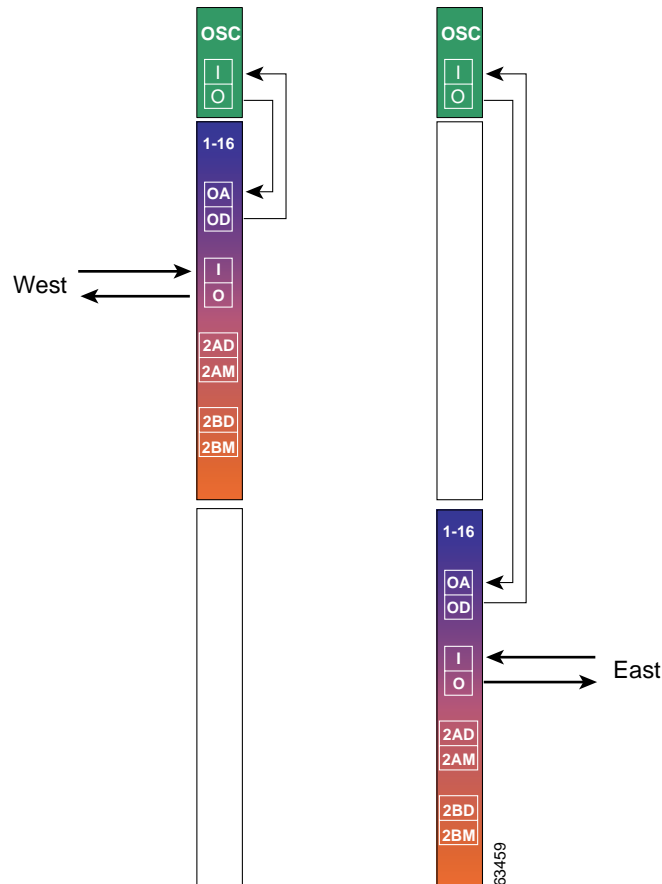

Figure 5-9 shows how the terminal mux/demux modules are cabled for the 16-channel line card protected point-to-point configuration.

Figure 5-9 Terminal Mux/Demux Module Cabling with OSC for Line Card Protected 16-Channel Point-to-Point Topology



Line Card Protected 32-Channel Point-to-Point Configuration

By cascading two Cisco ONS 15540 shelves, 32 channels can be supported in a line card protected point-to-point configuration. Shelf 1 is configured for channels 1–16 with OSC, while shelf 2 is configured for channels 17–32 without OSC. The terminal mux/demux modules are patched between the two shelves as if they were in the same shelf. In this configuration, shelf 2 cannot support the OSC, which means that a separate Ethernet connection to that shelf is required for management purposes.

The optical power budget for this configuration is the same as for a 32-channel unprotected configuration, shown in [Figure 5-1 on page 5-2](#).



Note

It is possible to use the 8-channel add/drop mux/demux modules in two shelves for a 32-channel line card protected configuration. However, we do not recommend this configuration because of the high optical power loss.

The configuration and terminal mux/demux cabling for shelf 1 in the line card protected 32-channel configuration are the same as for the line card protected 16-channel configuration, shown in [Figure 5-8 on page 5-7](#) and [Figure 5-9 on page 5-8](#). The configuration for shelf 2 is shown in [Figure 5-10](#). As in shelf 1, the west line card motherboards are used in slots 2–5, and the east line card motherboards are used in slots 8–11.

Figure 5-10 Shelf 2 Configuration for Line Card Protected 32-Channel Point-to-Point Topology

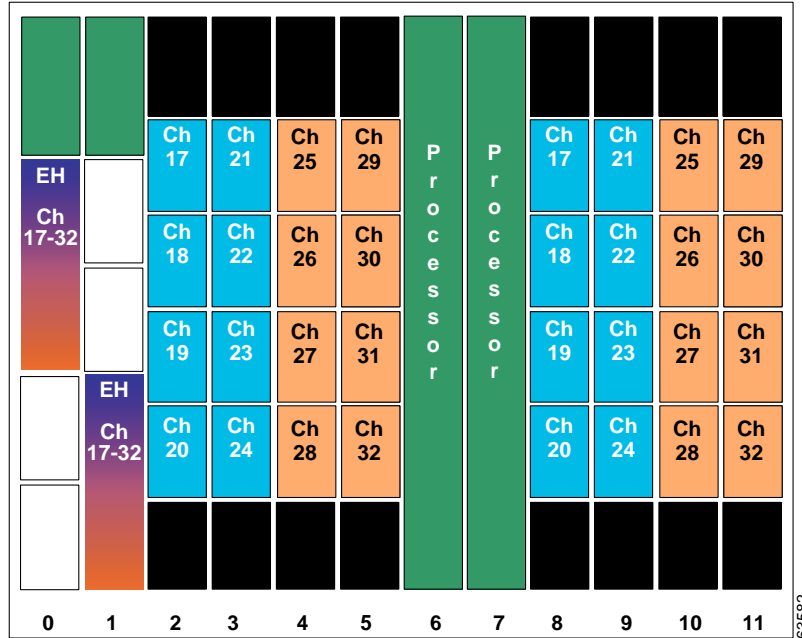

63582

Figure 5-11 shows how the terminal mux/demux modules are cabled between the two shelves to support all 32 channels on both the east and west sides.

Figure 5-11 Terminal Mux/Demux Module Cabling with Two Shelves for Line Card Protected 32-Channel Point-to-Point Topology

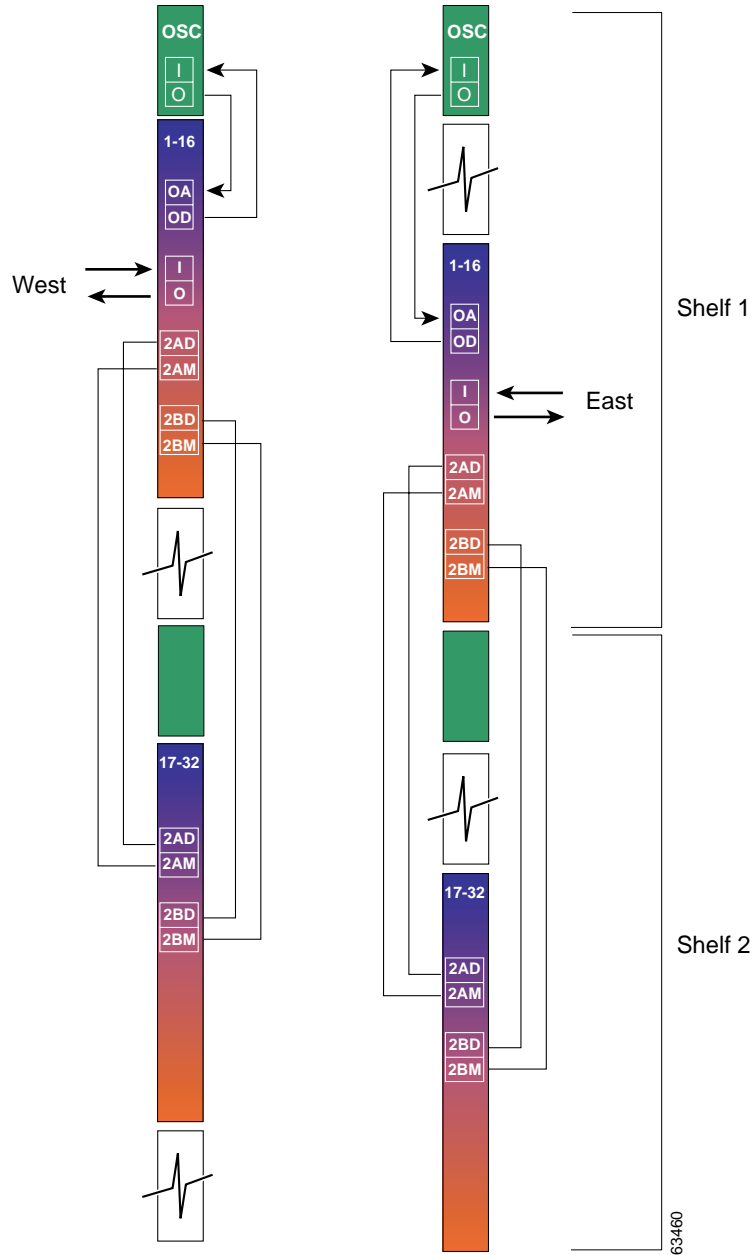

63460

Hubbed Ring Topologies

As described in the “Hubbed Ring” section on page 2-9, in a hubbed ring architecture one node serves as the hub (or terminal) node, while all other nodes perform add/drop functions. This type of topology is also sometimes called *hub and spoke*, because each of the spoke nodes is logically connected to only the hub node. In a hubbed ring, the hub can use terminal mux/demux modules, while each of the spoke nodes must be equipped with add/drop mux/demux modules.

Figure 5-12 shows the channel plan for a 16-channel hubbed ring where a band of four channels is dropped at each spoke node. The hub node in this example uses the 16-channel terminal mux/demux modules. The nodes communicate as follows:

- Nodes 1-2 over band A
- Nodes 1-3 over band B
- Nodes 1-4 over band C
- Nodes 1-5 over band D

Figure 5-12 Hubbed Ring Channel Plan

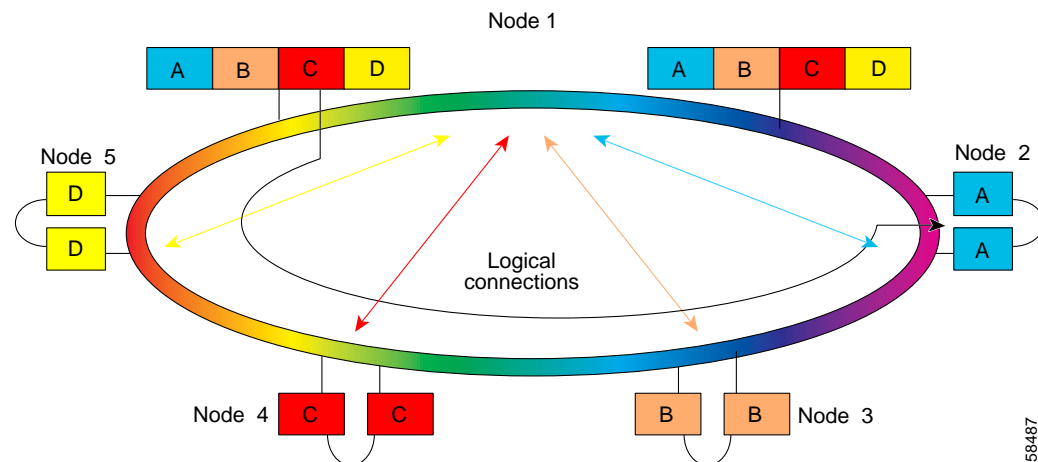

Splitter Protected Hubbed Ring Configuration

Assuming that all nodes were equidistant in the ring, the path with the greatest optical link loss (the “worst path”) would be the path for band A between node 1 and node 2. This path is shown in Figure 5-12 by the black line connecting node 1 to node 2 by way of nodes 5, 4, and 3.

Figure 5-13 shows the optical power loss through each of the components from node 1 to node 2 for band A, and for the OSC. This configuration uses the splitter protected line card motherboards.

Figure 5-13 Optical Power Budget for Splitter Protected Hubbed Ring

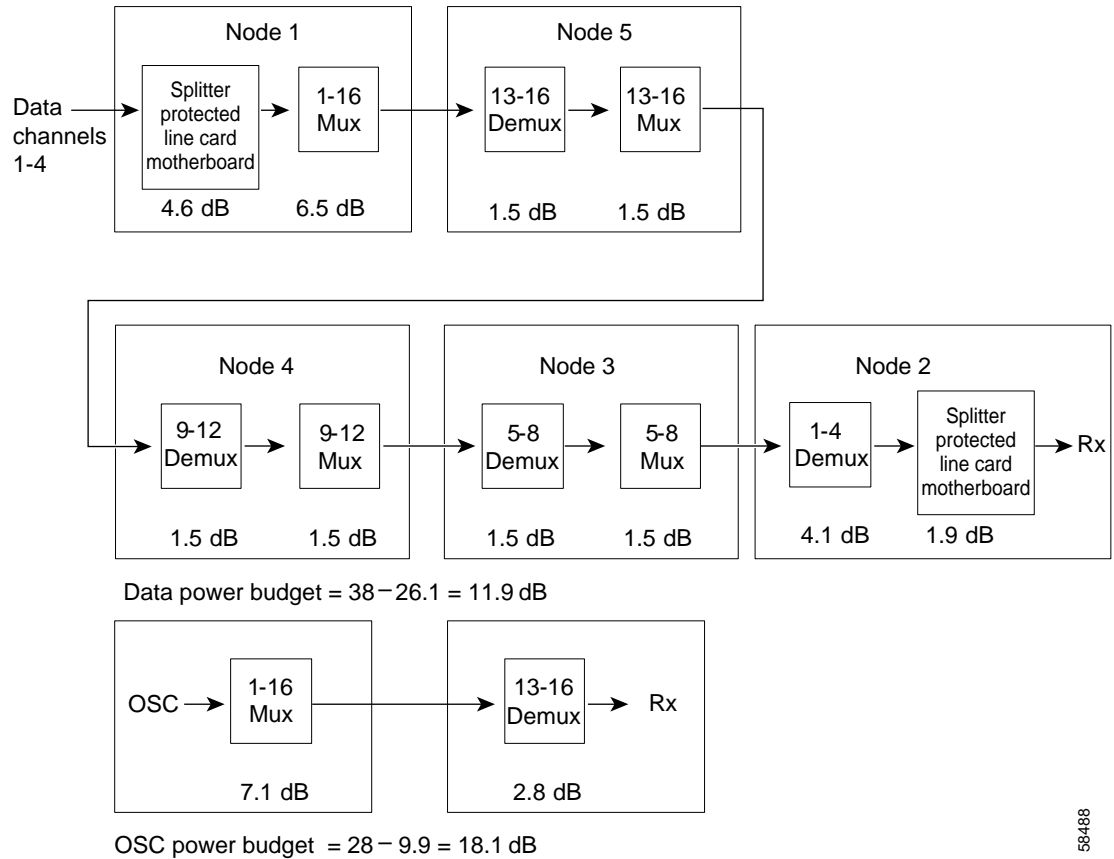

58488

Figure 5-14 shows how the hub node shelf is populated in the 16-channel splitter protected hubbed ring topology. Splitter protected line card motherboards are installed in slots 2–5, and the 16-channel terminal mux/demux modules are used in the east and west mux/demux slots.

Figure 5-14 Shelf Configuration for 16-Channel Hub Node in Splitter Protected Hubbed Ring

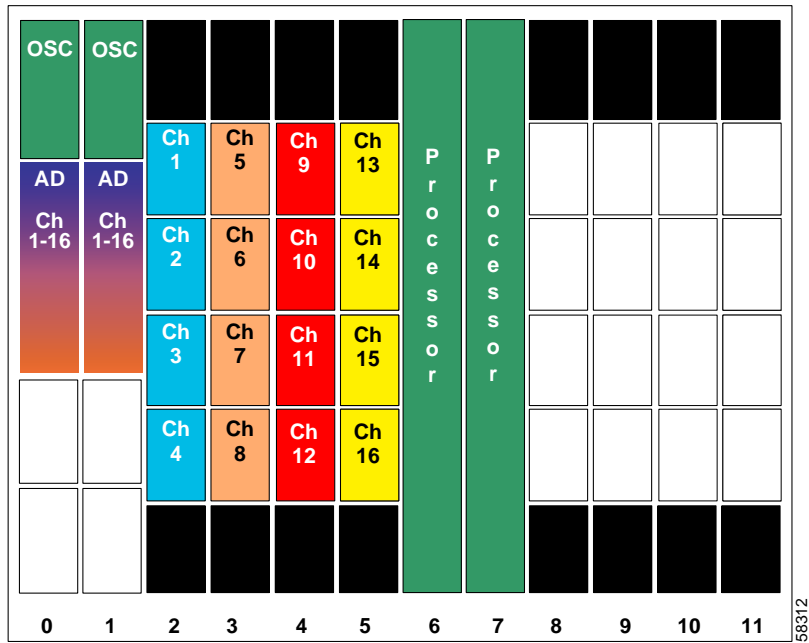

56312

Figure 5-15 shows how the 16-channel terminal mux/demux modules are cabled for the hub node in the splitter protected hubbed ring.

Figure 5-15 Terminal Mux/Demux Module Cabling with OSC for 16-Channel Hub Node in Splitter Protected Hubbed Ring

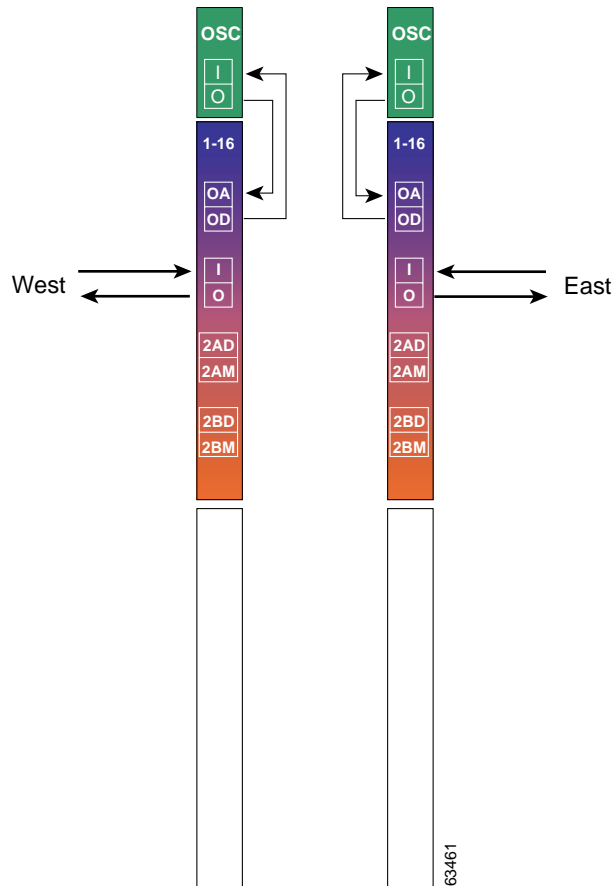

Figure 5-16 shows the shelf configuration for node 2 in the hubbed ring. A splitter protected line card motherboard is used in slot 2, and 4-channel mux/demux modules are used in subslot 0 of the east and west mux/demux slots.

Figure 5-16 Shelf Configuration for Node 2 in Splitter Protected Hubbed Ring

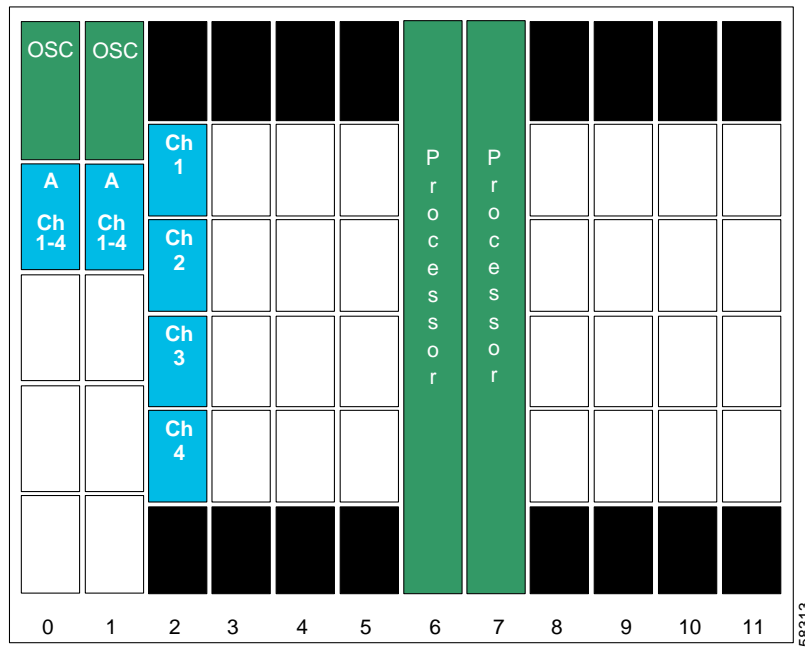

Figure 5-17 shows how the 4-channel mux/demux modules are cabled for node 2 in the splitter protected hubbed ring.

Figure 5-17 Add/Drop Mux/Demux Module Cabling with OSC for Node 2 in Splitter Protected Hubbed Ring

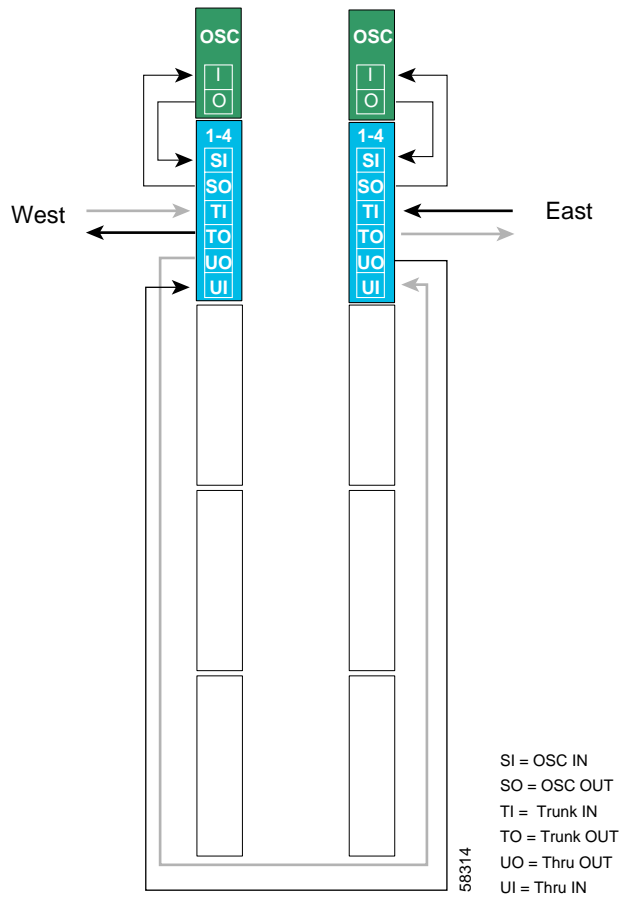

Figure 5-18 shows the shelf configuration for node 3 in the hubbed ring. A splitter protected line card motherboard is used in slot 5, and 4-channel mux/demux modules are used in subslot 1 of the east and west mux/demux slots.

Figure 5-18 Shelf Configuration for Node 3 in Splitter Protected Hubbed Ring

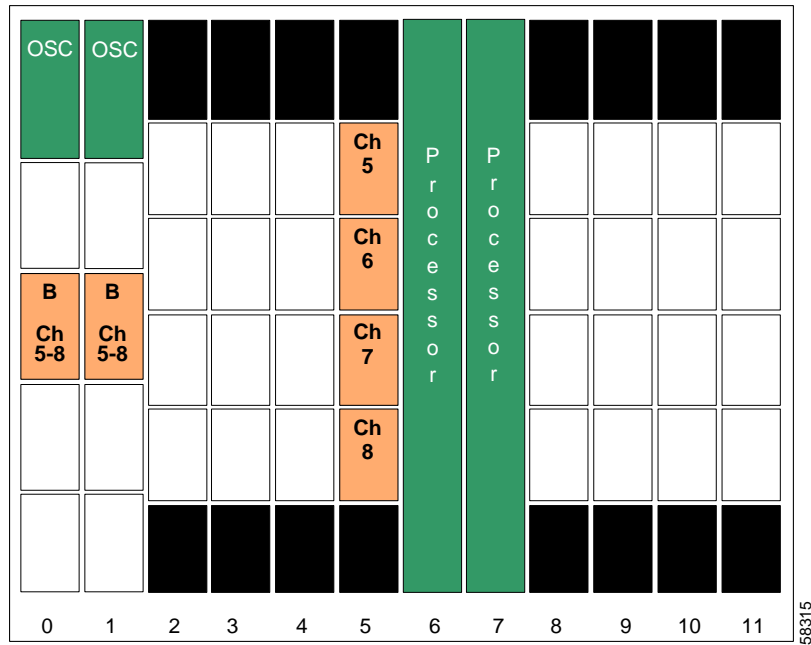

Figure 5-19 shows how the 4-channel mux/demux modules are cabled for node 3 in the splitter protected hubbed ring.

Figure 5-19 Add/Drop Mux/Demux Module Cabling with OSC for Node 3 in Splitter Protected Hubbed Ring

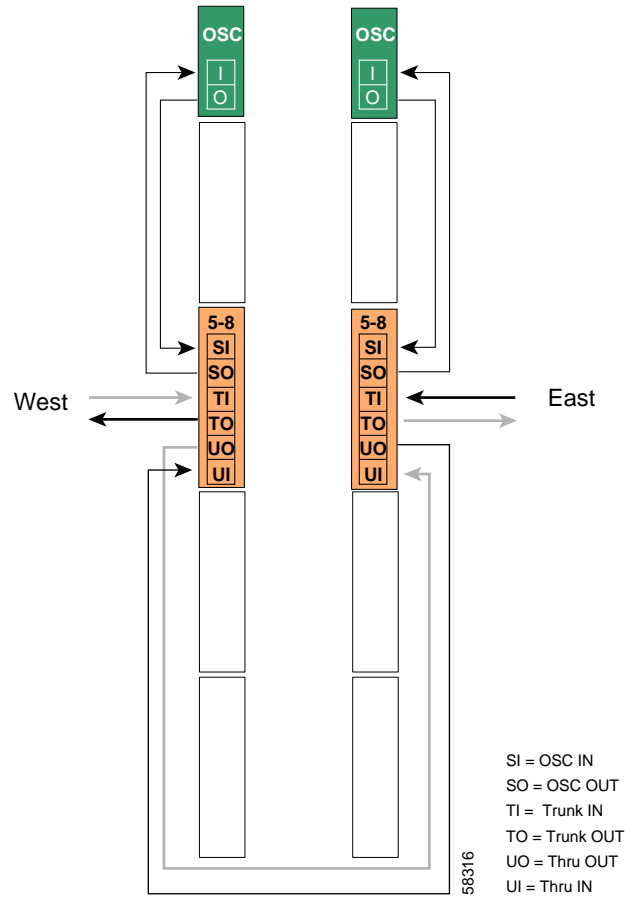

Figure 5-20 shows the shelf configuration for node 4 in the hubbed ring. A splitter protected line card motherboard is used in slot 8, and 4-channel mux/demux modules are used in subslot 2 of the east and west mux/demux slots.

Figure 5-20 Shelf Configuration for Node 4 in Splitter Protected Hubbed Ring

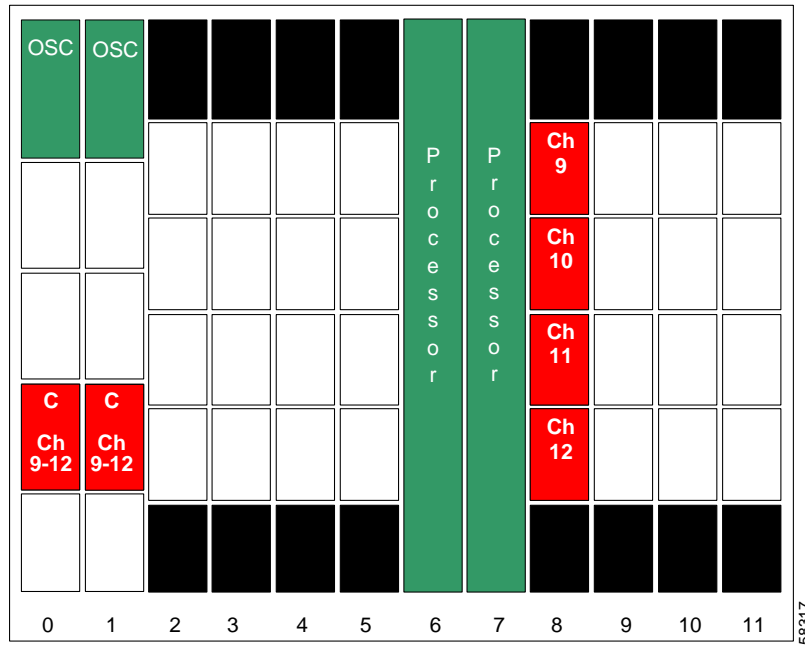

Figure 5-21 shows how the 4-channel mux/demux modules are cabled for node 4 in the splitter protected hubbed ring.

Figure 5-21 Add/Drop Mux/Demux Module Cabling with OSC for Node 4 in Splitter Protected Hubbed Ring

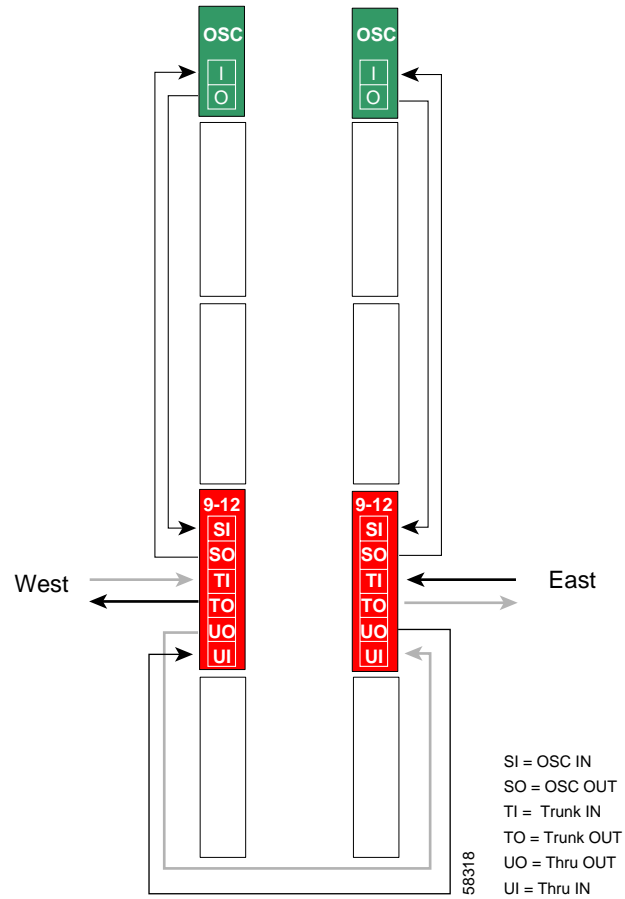

Figure 5-22 shows the shelf configuration for node 5 in the hubbed ring. A splitter protected line card motherboard is used in slot 11, and 4-channel mux/demux modules are used in subplot 3 of the east and west mux/demux slots.

Figure 5-22 Shelf Configuration for Node 5 in Splitter Protected Hubbed Ring

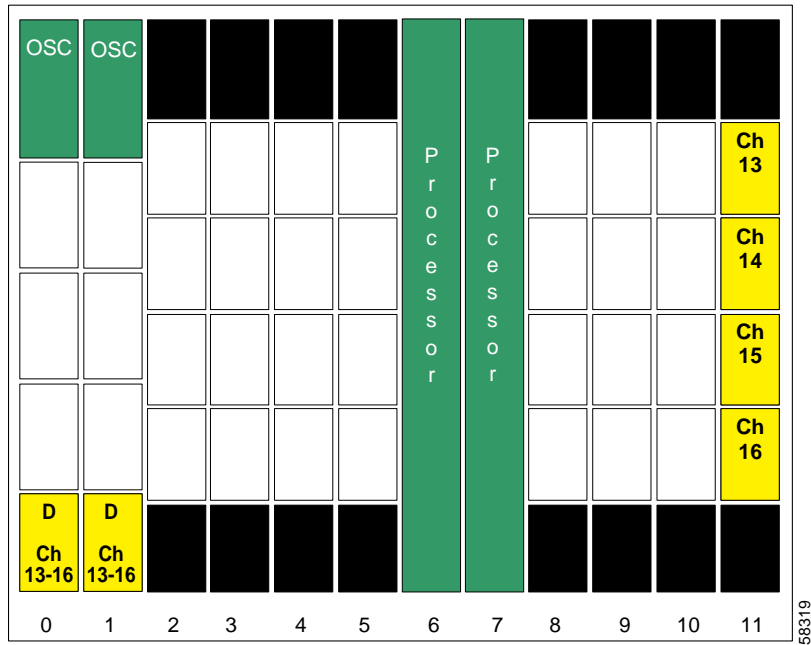
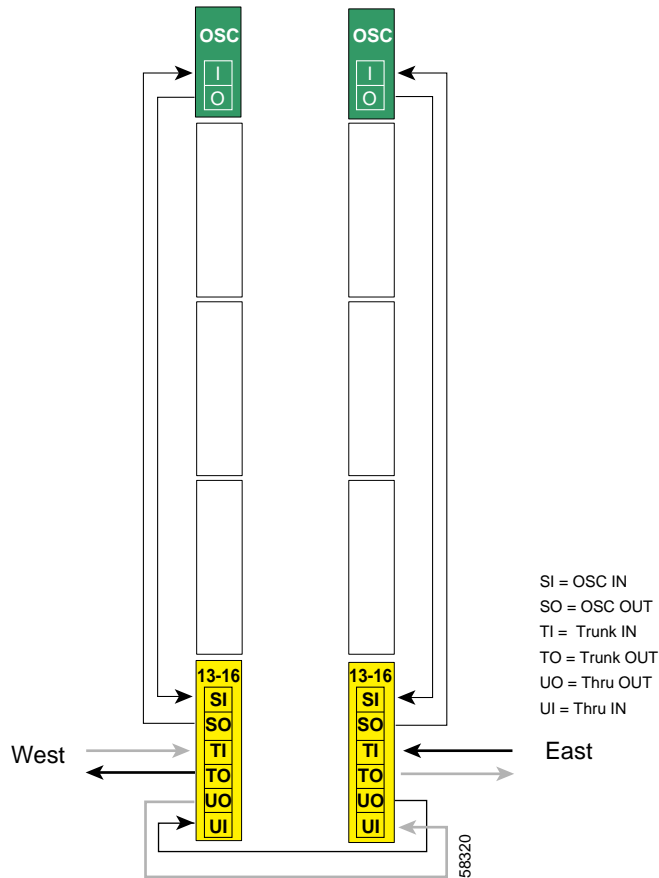

Figure 5-23 shows how the 4-channel mux/demux modules are cabled for node 4 in the splitter protected hubbed ring.

Figure 5-23 Add/Drop Mux/Demux Module Cabling with OSC for Node 5 in Splitter Protected Hubbed Ring



Line Card Protected Hubbed Ring Configuration

With line card protection, a single Cisco ONS 15540 shelf can support a maximum of 16 channels at the hub node in a hubbed ring. Using two cascaded shelves, 32 channels can be supported. The configuration for the two shelves that form the hub node is the same as the one described in the “[Line Card Protected 32-Channel Point-to-Point Configuration](#)” section on page 5-8.

Figure 5-24 shows the optical power budget for the hubbed ring with line card protection. The figure shows the optical power loss for each of the components traversed by the channels in band A from node 1 to node 2 over nodes 5, 4, and 3 (see Figure 5-12 on page 5-11). Assuming that the nodes are equidistant, this would be the worst path. This configuration uses the east and west line card motherboards.

Figure 5-24 Optical Power Budget for Line Card Protected Hubbed Ring

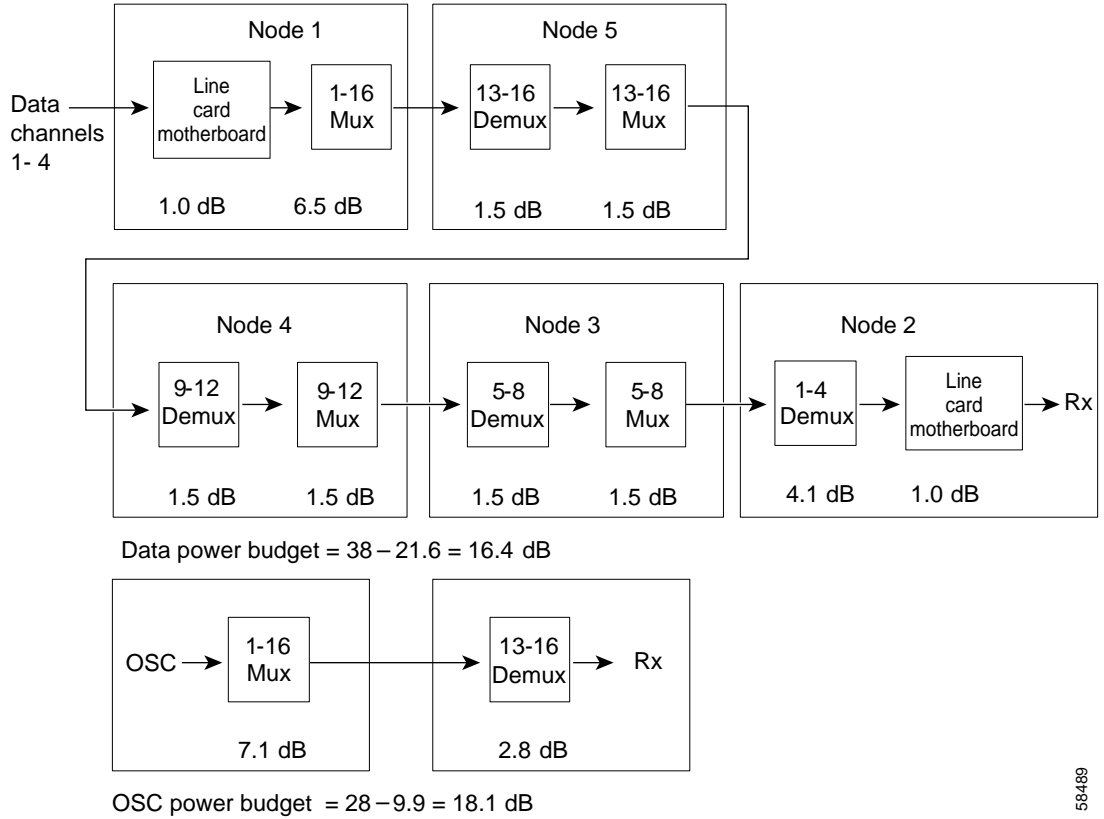

58489

Figure 5-25 shows the shelf configuration for the hub node in this hubbed ring example. The line card motherboards in slots 2–5 are west motherboards, corresponding to the 16-channel mux/demux module in the west mux/demux slot; the line card motherboards in slots 8–11 are east motherboards, corresponding to the 16-channel mux/demux module in the east mux/demux slot.

Figure 5-25 Shelf Configuration for Hub Node in Line Card Protected Hubbed Ring

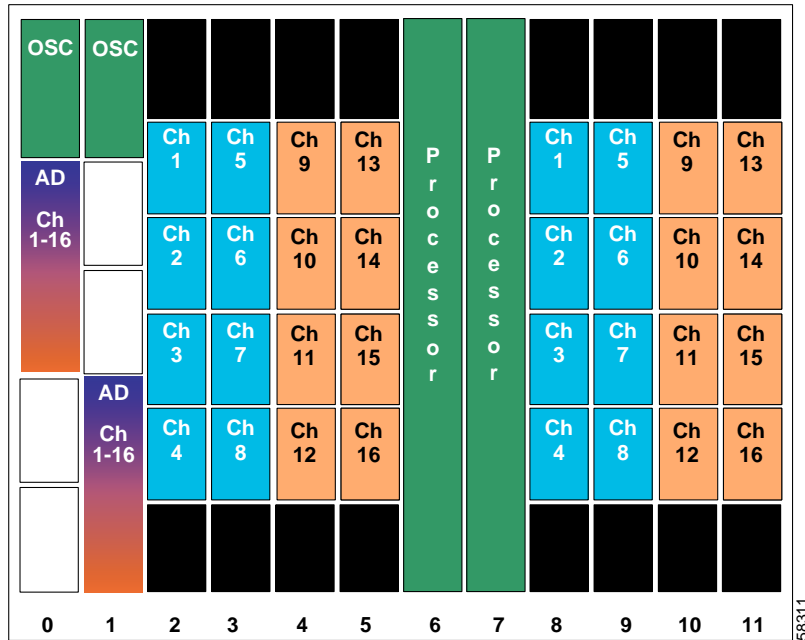

Figure 5-26 shows how the 16-channel mux/demux modules are cabled for the hub node in the line card protected hubbed ring.

Figure 5-26 Terminal Mux/Demux Module Cabling with OSC for Hub Node in Line Card Protected Hubbed Ring

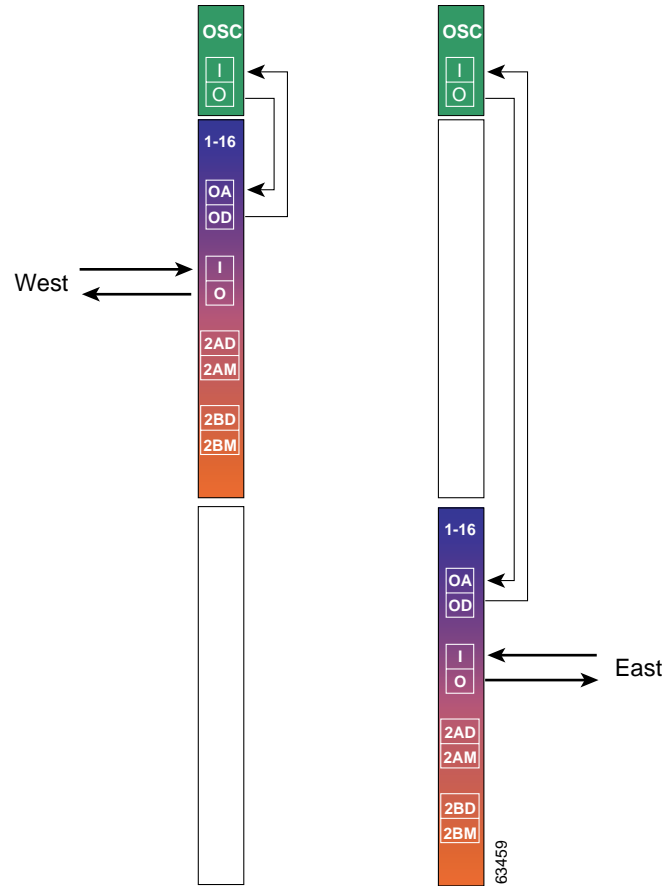

Figure 5-27 shows the shelf configuration for node 2 in the line card protected hubbed ring. Slot 2 uses a west line card motherboard, corresponding to the add/drop mux/demux module in the west mux/demux slot; slot 4 uses an east line card motherboard, corresponding to the add/drop mux/demux module in the east mux/demux slot.

Figure 5-27 Shelf Configuration for Node 2 in Line Card Protected Hubbed Ring

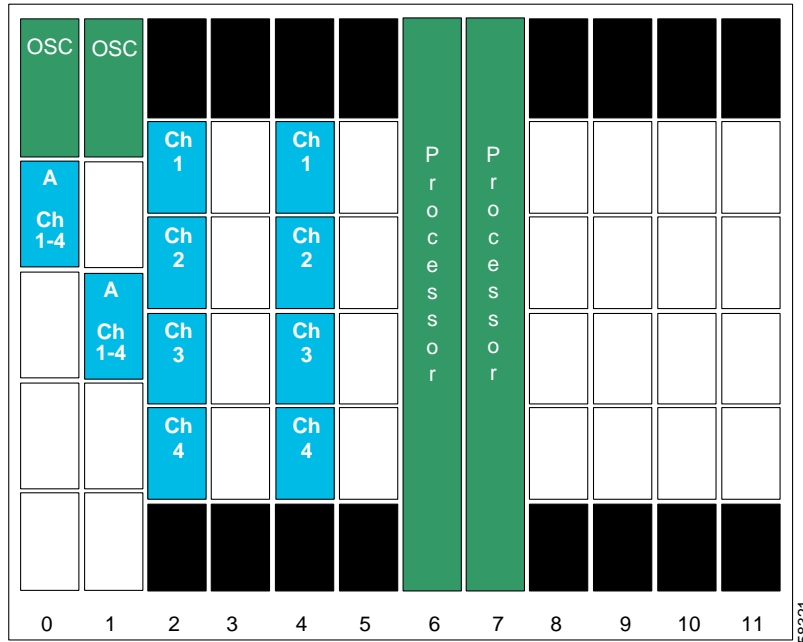

Figure 5-28 shows how the 4-channel mux/demux modules are cabled for node 2 in the line card protected hubbed ring.

Figure 5-28 Add/Drop Mux/Demux Module Cabling with OSC for Node 2 in Line Card Protected Hubbed Ring

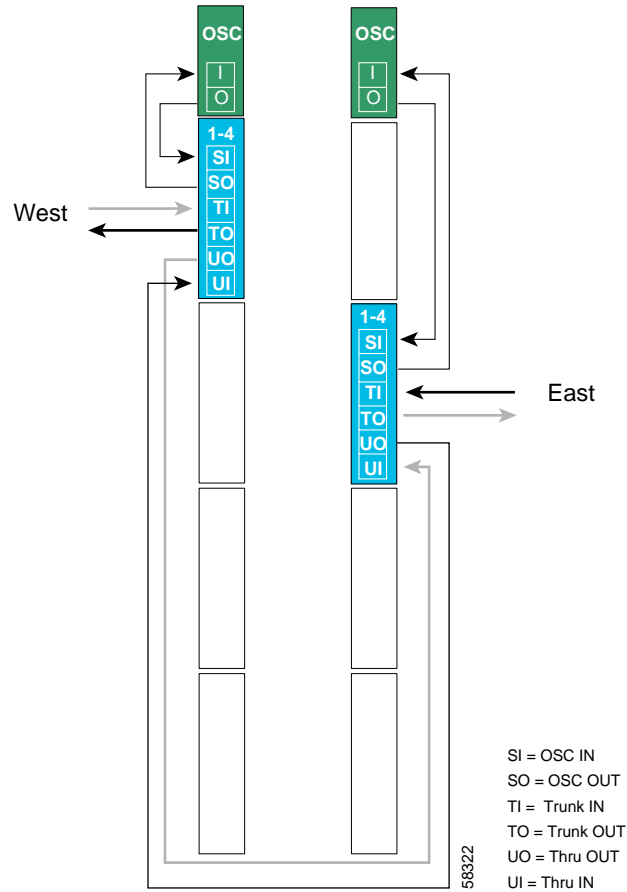

Figure 5-29 shows the shelf configuration for node 3 in the hubbed ring. Slot 3 uses an east line card motherboard, corresponding to the add/drop mux/demux module in the east mux/demux slot; slot 5 uses a west line card motherboard, corresponding to the add/drop mux/demux module in the west mux/demux slot.

Figure 5-29 Shelf Configuration for Node 3 in Line Card Protected Hubbed Ring

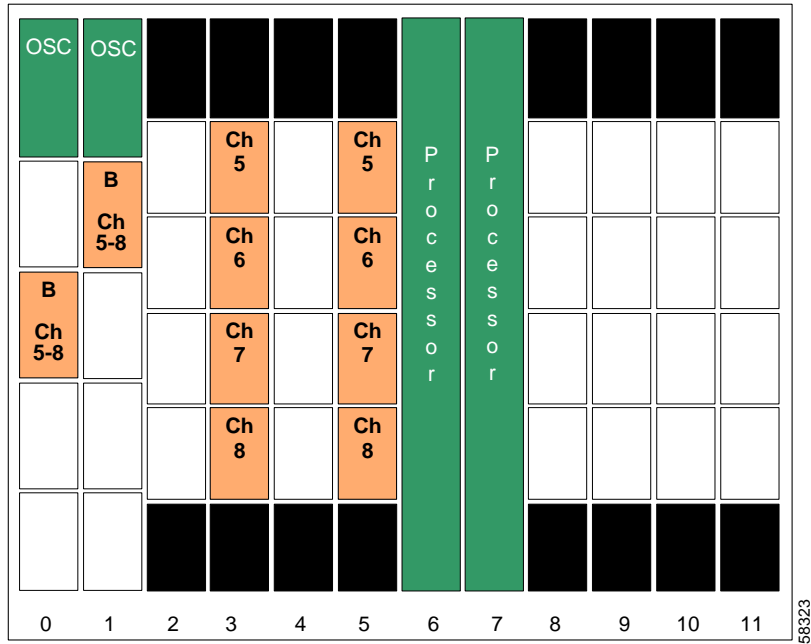

Figure 5-30 shows how the 4-channel mux/demux modules are cabled for node 3 in the line card protected hubbed ring.

Figure 5-30 Add/Drop Mux/Demux Module Cabling with OSC for Node 3 in Line Card Protected Hubbed Ring

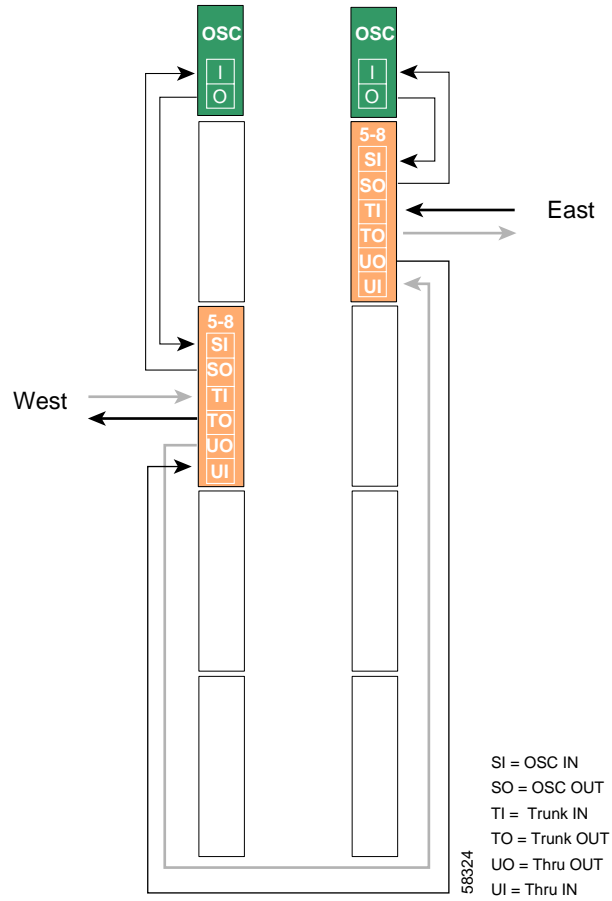

Figure 5-31 shows the shelf configuration for node 4 in the line card protected hubbed ring. Slot slot 8 uses a west line card motherboard, corresponding to the add/drop mux/demux module in the west mux/demux slot; slot 10 uses an east line card motherboard, corresponding to the add/drop mux/demux module in the east mux/demux slot.

Figure 5-31 Shelf Configuration for Node 4 in Line Card Protected Hubbed Ring

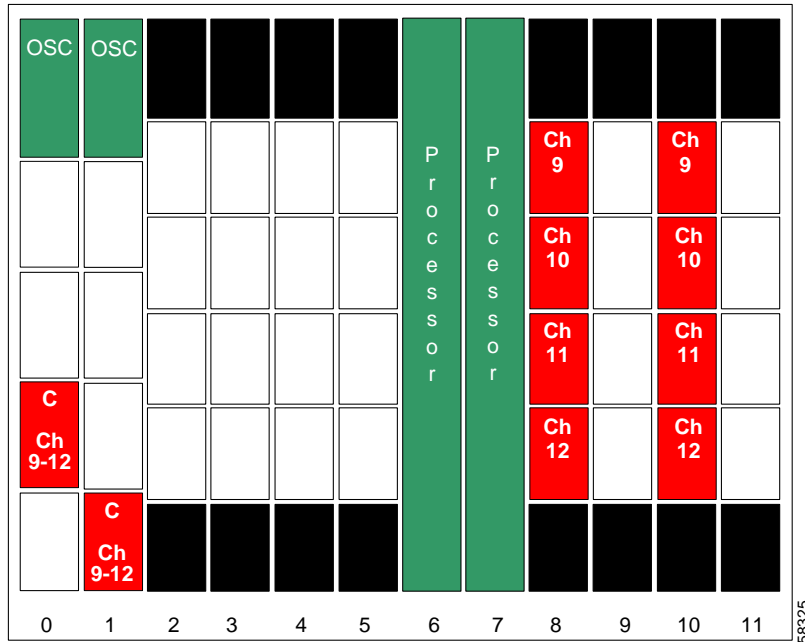

Figure 5-32 shows how the 4-channel mux/demux modules are cabled for node 4 in the line card protected hubbed ring.

Figure 5-32 Add/Drop Mux/Demux Module Cabling with OSC for Node 4 in Line Card Protected Hubbed Ring

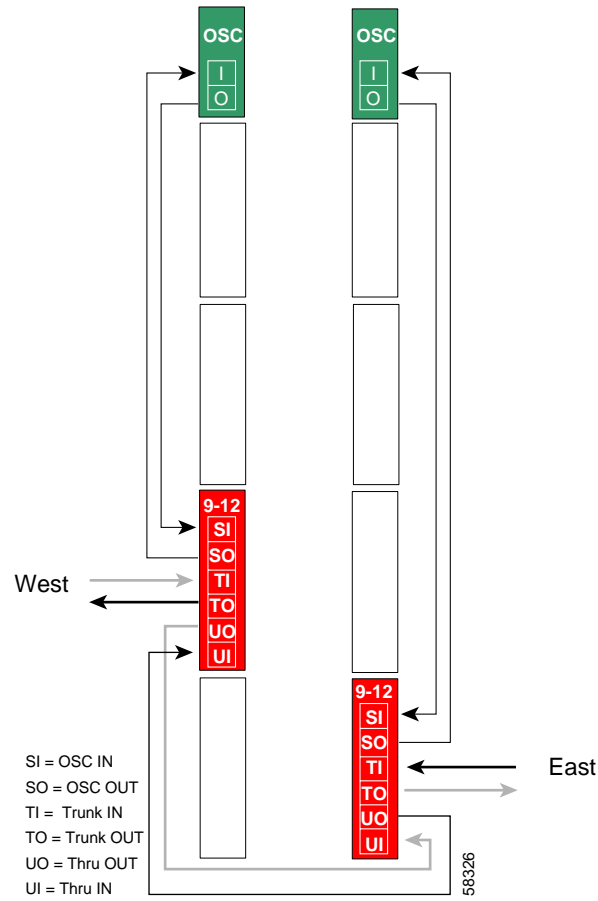
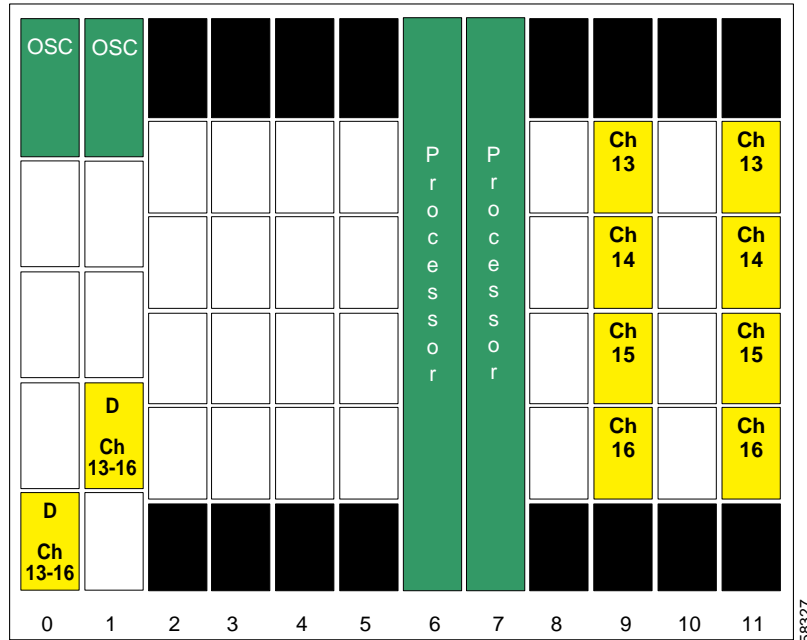

Figure 5-33 shows the shelf configuration for node 5 in the line card protected hubbed ring. Slot 9 uses an east line card motherboard, corresponding to the add/drop mux/demux module in the east mux/demux slot; slot 11 uses a west line card motherboard, corresponding to the add/drop mux/demux module in the west mux/demux slot.

Figure 5-33 Shelf Configuration for Node 5 in Line Card Protected Hubbed Ring



58327

Figure 5-34 shows how the 4-channel mux/demux modules are cabled for node 5 in the line card protected hubbed ring.

Figure 5-34 Add/Drop Mux/Demux Module Cabling with OSC for Node 5 in Line Card Protected Hubbed Ring

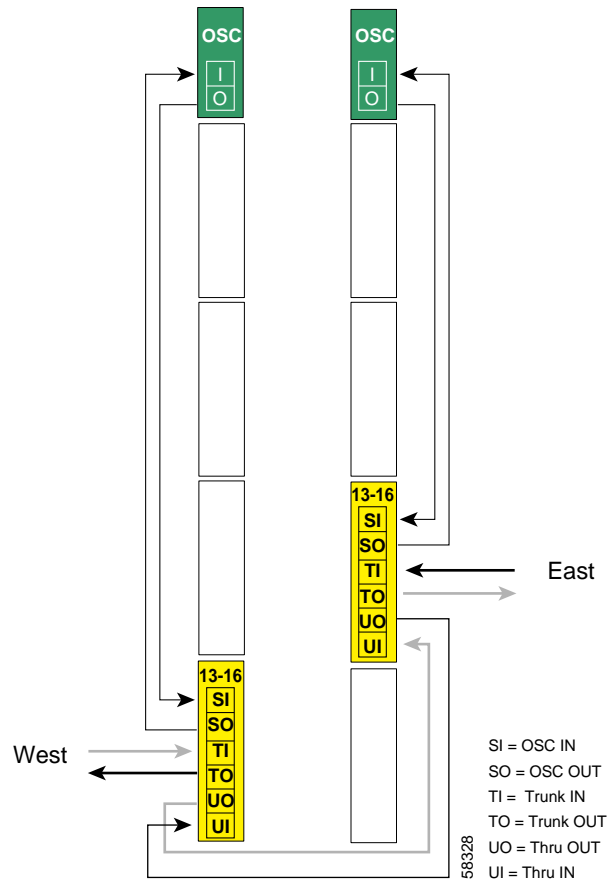

Meshed Ring Topologies

As explained in the “[Meshed Ring](#)” section on page 2-10, in a full logical mesh, every node can communicate with every other node. In some cases, this is not necessary and a partial mesh is formed.

Figure 5-35 shows the channel plan for a 16-channel partial meshed ring. The nodes communicate as follows:

- Nodes 1-2 over band A (path of greatest optical power loss, assuming all nodes are equidistant)
- Nodes 1-3 over band B
- Nodes 1-4 over band C
- Nodes 3-4 over band D

Figure 5-35 Channel Plan for Meshed Ring

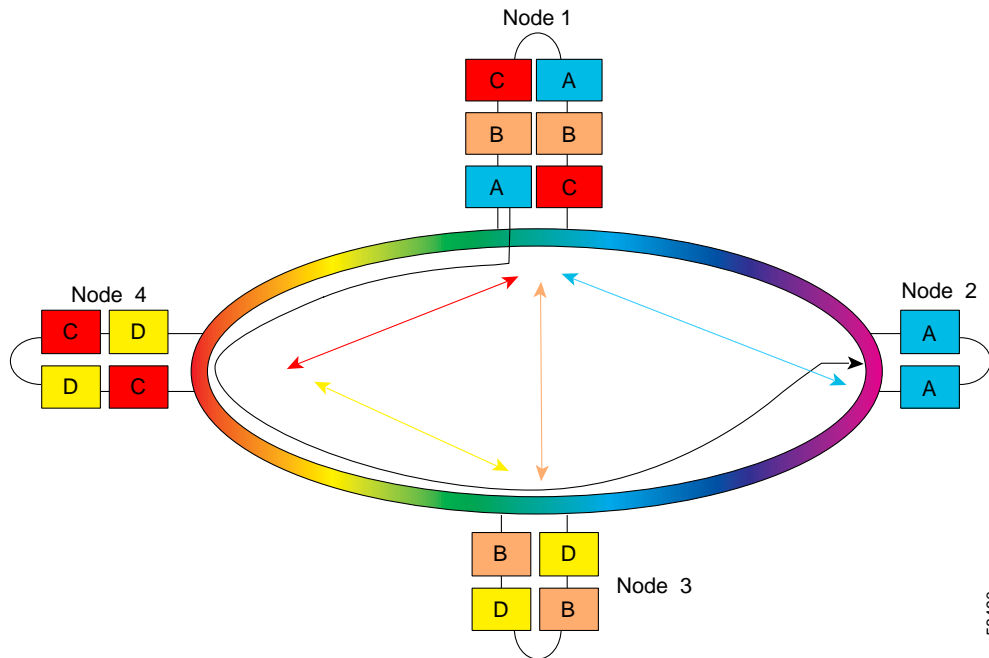

Band allocation and the ordering of the optical mux/demux modules becomes especially important in a mesh environment because of the increased possibility of multiple mux/demux modules at a particular node. The example in Figure 5-35 shows the network configured exclusively with 4-channel add/drop mux/demux modules.

Band allocation can have an effect on both the cost and optical power budget of the network. In this example, it is possible to replace the 4-channel mux/demux modules for bands A and B in node 1 with the 8-channel AB band mux/demux modules. Likewise, the 4-channel mux/demux modules in node 4 could be replaced with 8-channel modules. The effect of this swap would be to lower the cost, but also to decrease the optical power budget, as the add and drop loss for an 8-channel module is greater than that for a 4-channel module.

The concept of ordering can become prominent in mesh topologies. As indicated by the black line in Figure 5-35, the path with the most loss (assuming equidistant nodes on the ring) is the one for band A from the west mux/demux motherboard of node 1 to the east motherboard of node 2, traversing nodes 4 and 3. Notice that in the west direction the add/drop mux/demux module for band A on node 1 is positioned closer to the trunk than bands B or C. As a result, band A does not pass through any of the other add/drop mux/demux modules located at node 1. Band B channels must pass through the band A mux/demux, while band C must pass through the mux/demux modules for both band B and band A.

Splitter Protected Meshed Ring Configuration

Figure 5-36 shows the optical power loss for each of the components traversed by the channels in band A from node 1 to node 2 over nodes 4 and 3. This configuration uses the splitter protected line card motherboards.

Figure 5-36 Optical Power Budget for Splitter Protected Meshed Ring

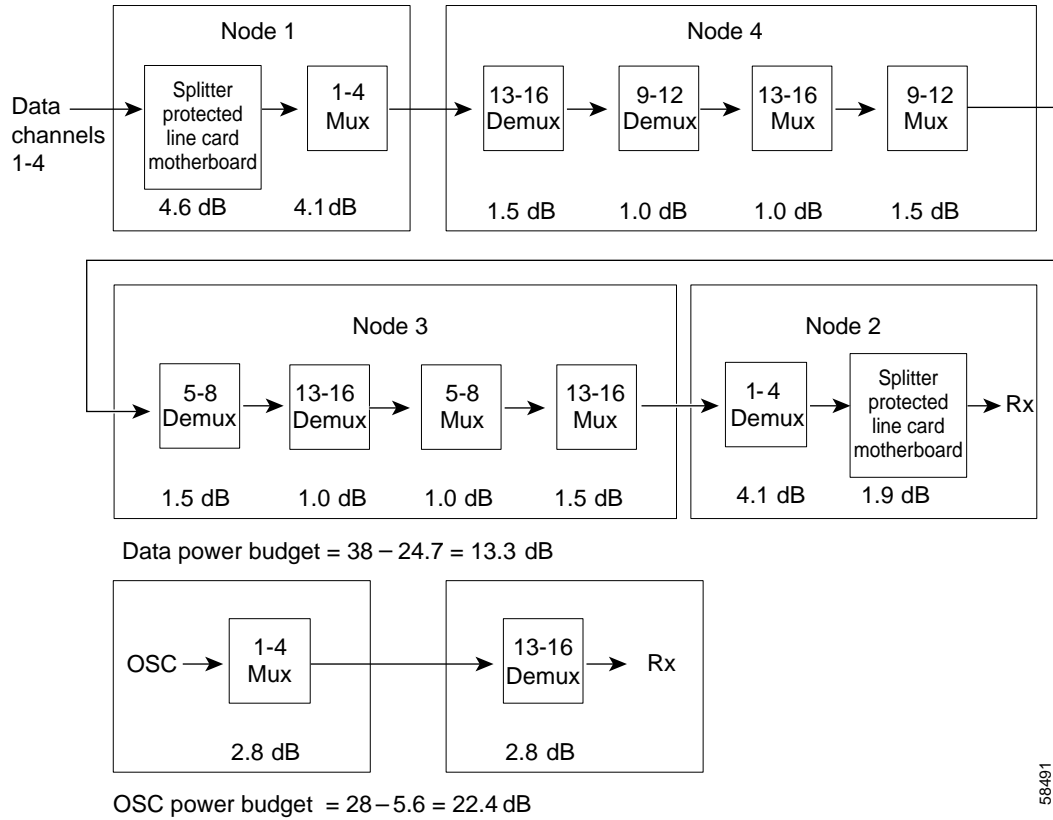

58491

Figure 5-37 shows the shelf configuration for node 1 in the splitter protected meshed ring. Splitter protected line card motherboards are used to couple the signal to the add/drop mux/demux modules in both west and east mux/demux slots.

Figure 5-37 Shelf Configuration for Node 1 in Splitter Protected Meshed Ring

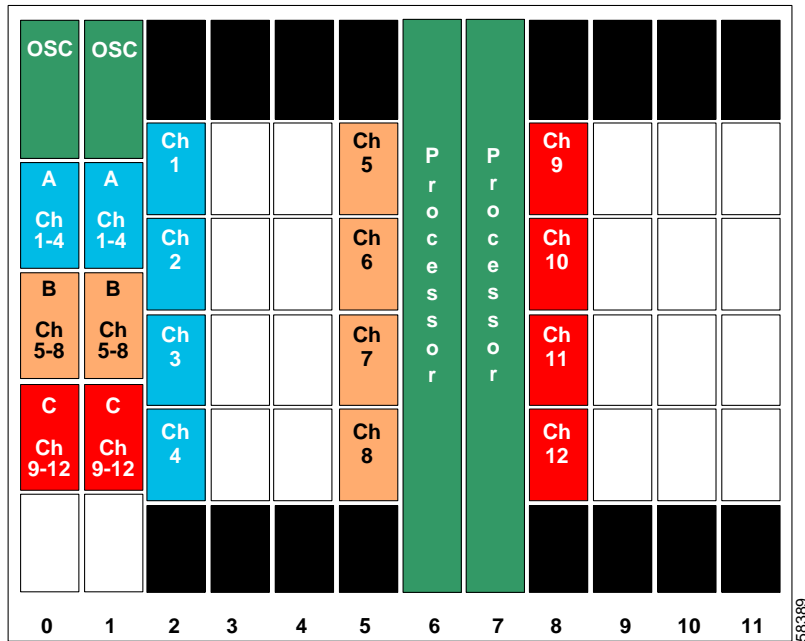

Figure 5-38 shows how the 4-channel mux/demux modules are cabled for node 1 in the splitter protected meshed ring.

Figure 5-38 Add/Drop Mux/Demux Module Cabling with OSC for Node 1 in Splitter Protected Meshed Ring

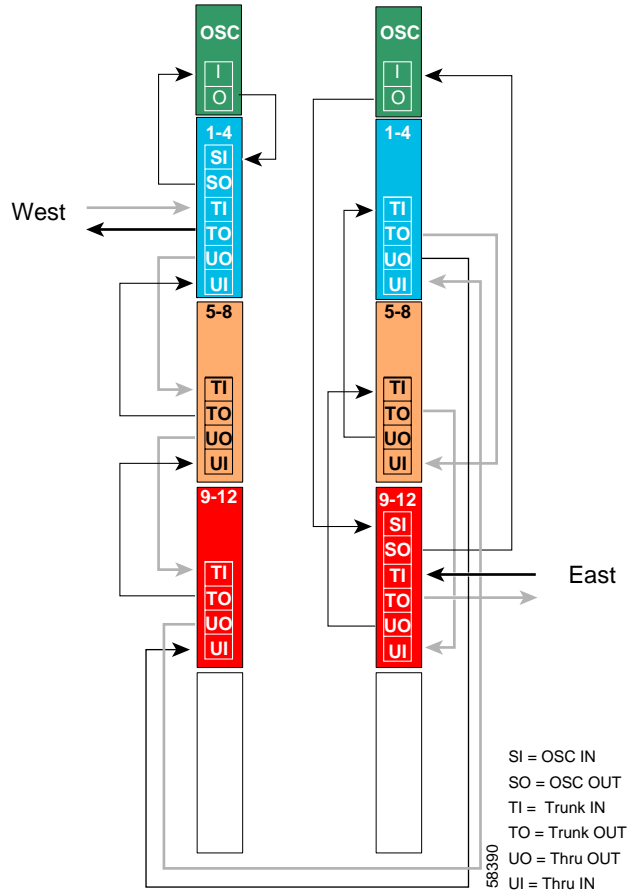

Figure 5-39 shows the shelf configuration for node 2 in the splitter protected meshed ring. Slot 2 uses the splitter protected line card motherboard, which couples the signal to the add/drop mux/demux modules in both west and east mux/demux slots.

Figure 5-39 Shelf Configuration for Node 2 in Splitter Protected Meshed Ring

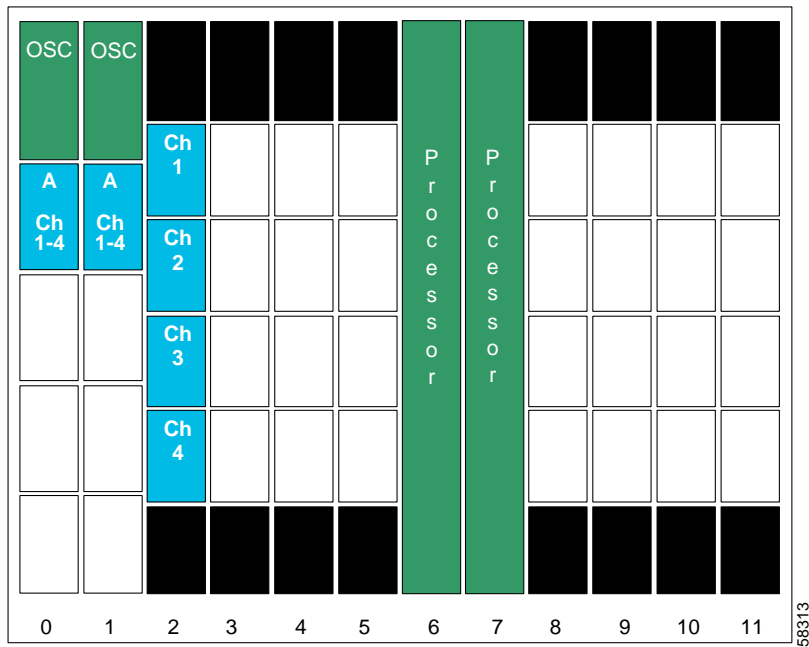

Figure 5-40 shows how the 4-channel mux/demux modules are cabled for node 2 in the splitter protected meshed ring.

Figure 5-40 Add/Drop Mux/Demux Module Cabling with OSC for Node 2 in Splitter Protected Meshed Ring

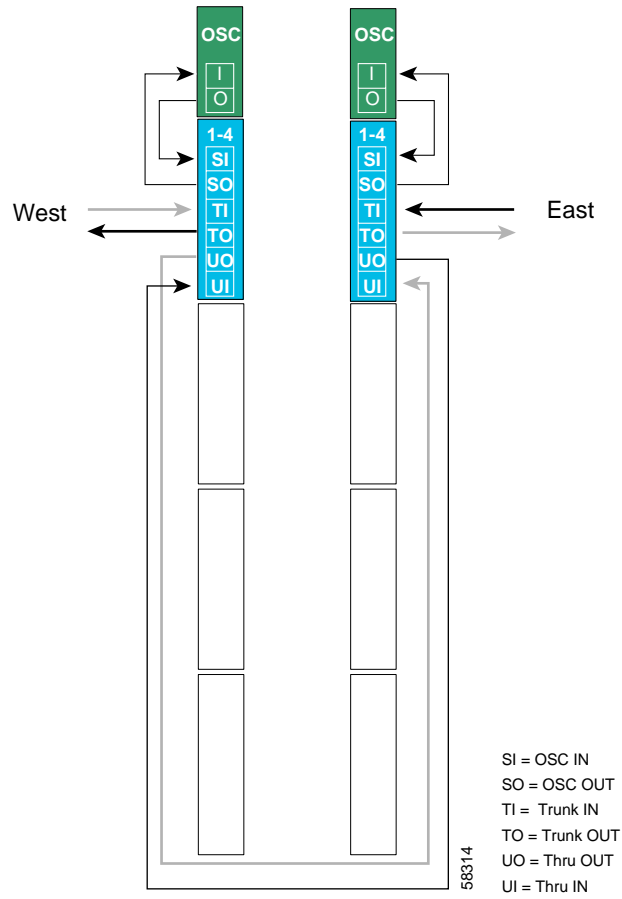

Figure 5-41 shows the shelf configuration for node 3 in the splitter protected meshed ring. Slots 5 and 11 use splitter protected line card motherboards, which couple the signal to the add/drop mux/demux modules in both west and east mux/demux slots.

Figure 5-41 Shelf Configuration for Node 3 in Splitter Protected Meshed Ring

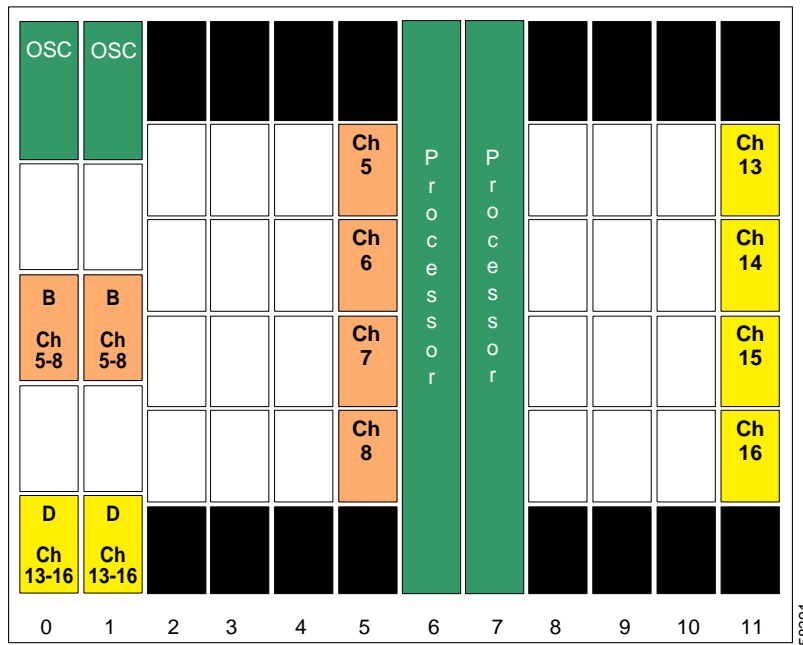

Figure 5-42 shows how the 4-channel mux/demux modules are cabled for node 3 in the splitter protected meshed ring.

Figure 5-42 Add/Drop Mux/Demux Module Cabling with OSC for Node 3 in Splitter Protected Meshed Ring

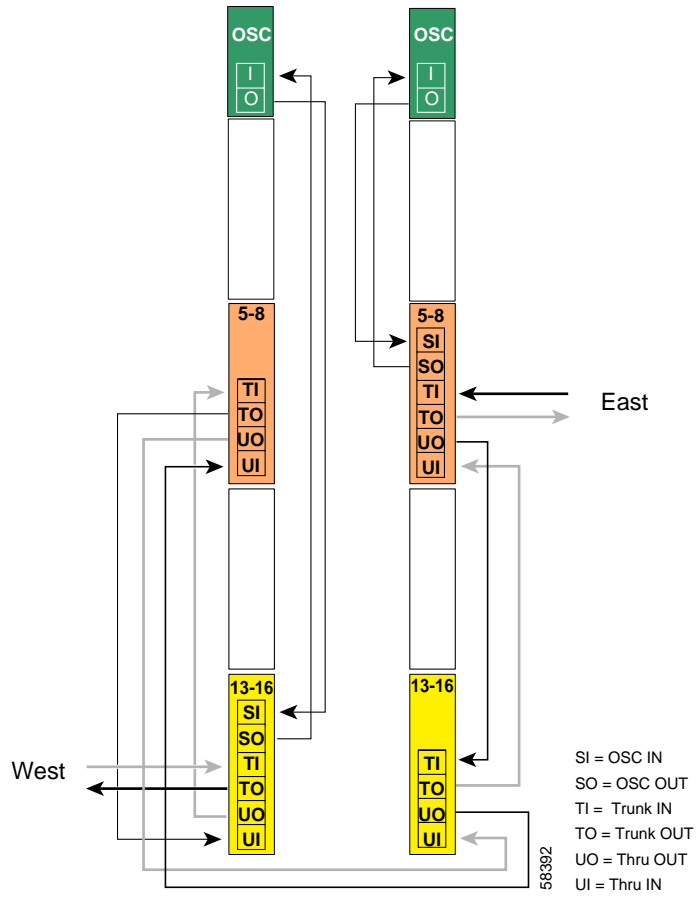

Figure 5-43 shows the shelf configuration for node 4 in the splitter protected meshed ring. Slots 8 and 11 use the splitter protected line card motherboards, which couple the signal to the add/drop mux/demux modules in both the west and east mux/demux slots.

Figure 5-43 Shelf Configuration for Node 4 in Splitter Protected Meshed Ring

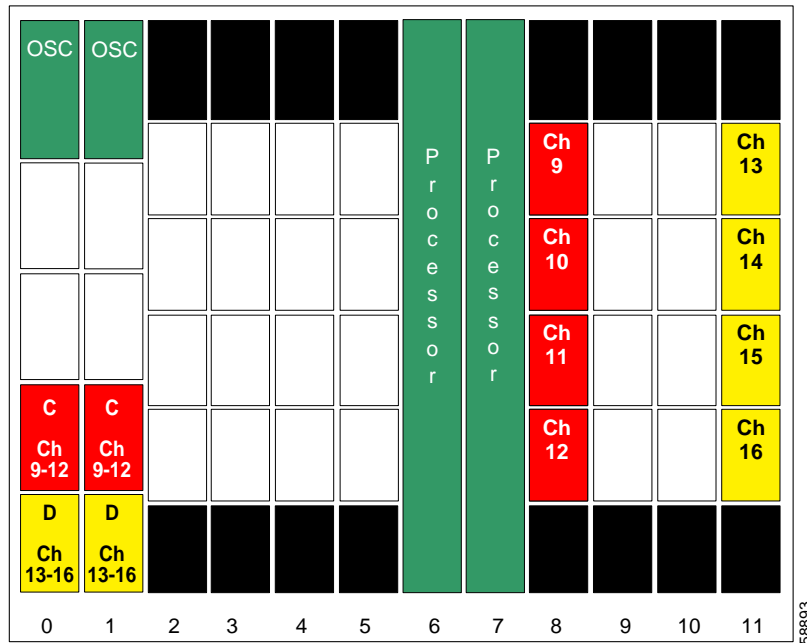
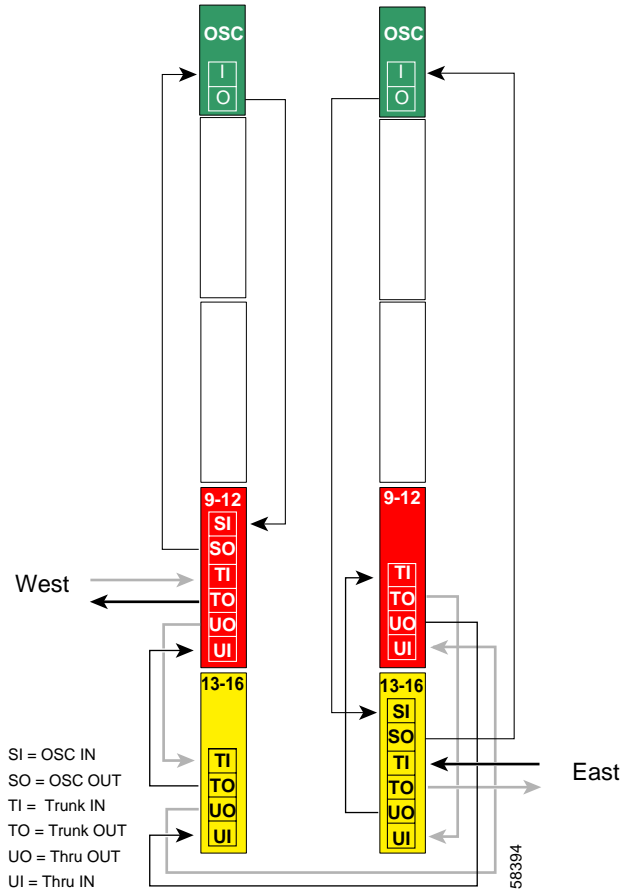

Figure 5-44 shows how the 4-channel mux/demux modules are cabled for node 4 in the splitter protected meshed ring.

Figure 5-44 Add/Drop Mux/Demux Module Cabling with OSC for Node 4 in Splitter Protected Meshed Ring



Line Card Protected Meshed Ring Configuration

Figure 5-45 shows the optical power budget for the hubbed ring with line card protection. The figure shows the optical power loss for each of the components traversed by the channels in band A between node 1 and node 2 over node 4 and node 3 (see Figure 5-35 on page 5-34). Assuming the nodes in the ring are equidistant, this would be the worst path. This configuration uses the east and west line card motherboards.

Figure 5-45 Optical Power Budget for Line Card Protected Meshed Ring

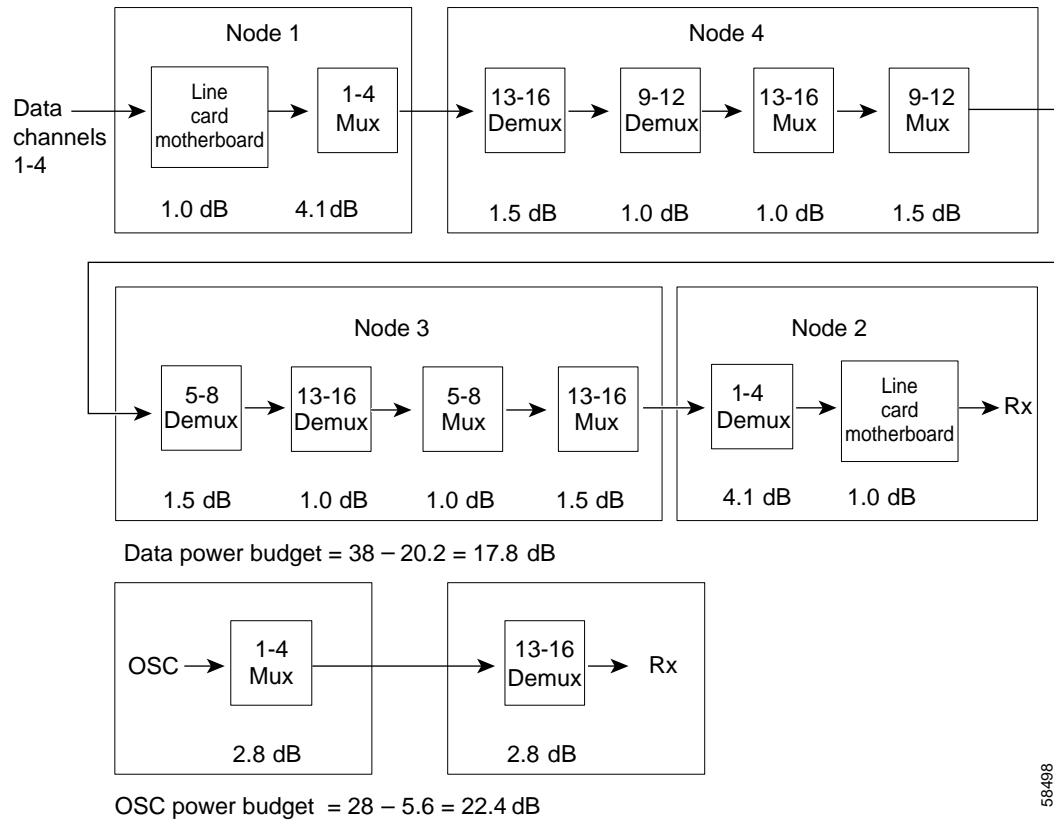
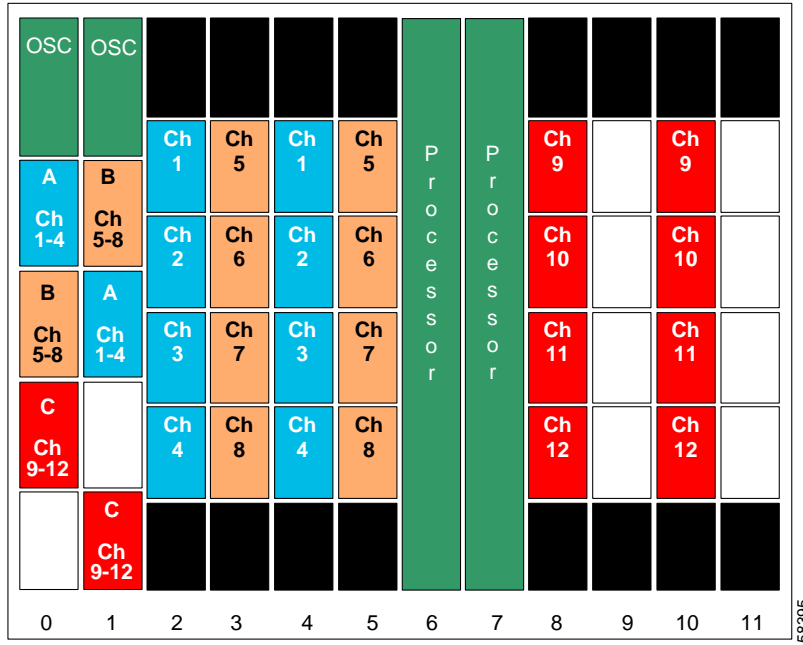

Figure 5-46 shows the shelf configuration for node 1 using line card protection in the example meshed ring. Slots 2, 5, and 8 use west line card motherboards, corresponding to the add/drop mux/demux modules in the west mux/demux slot; slots 3, 4, and 10 use east line card motherboards, corresponding to the add/drop mux/demux modules in the east mux/demux slot.

Figure 5-46 Shelf Configuration for Node 1 in Line Card Protected Meshed Ring



58395

Figure 5-47 shows how the 4-channel mux/demux modules are cabled for node 1 in the line card protected meshed ring.

Figure 5-47 Add/Drop Mux/Demux Module Cabling with OSC for Node 1 in Line Card Protected Meshed Ring

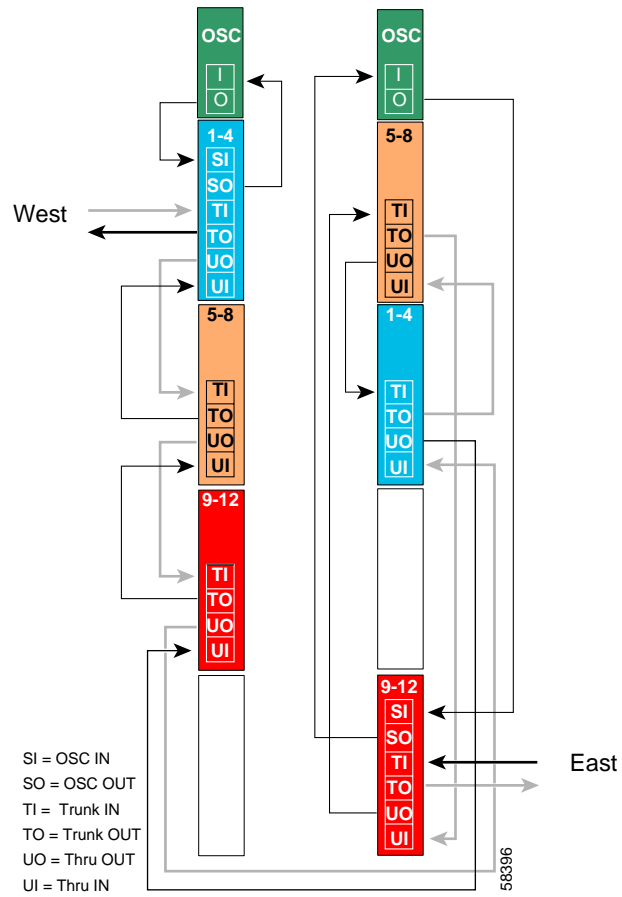
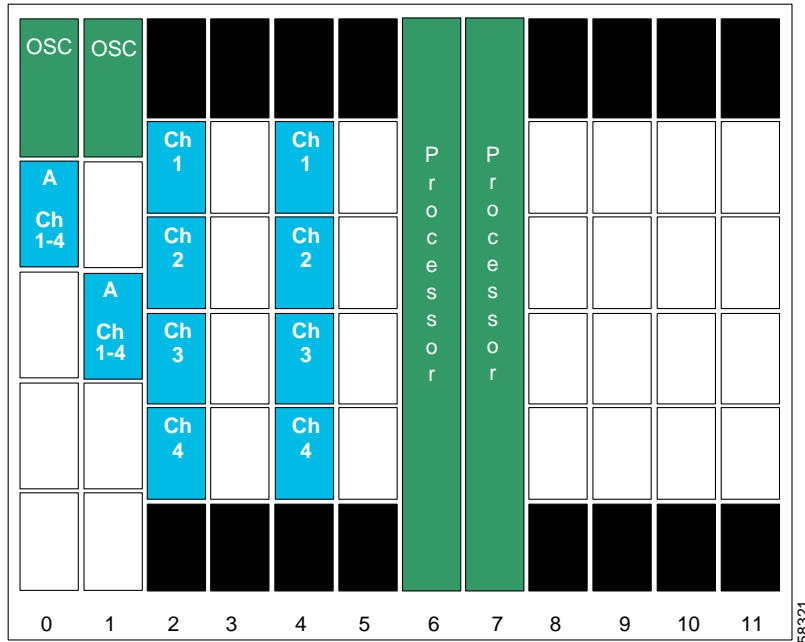

Figure 5-48 shows the shelf configuration for node 2 in the line card protected meshed ring. Slot 2 uses the west line card motherboard, corresponding to the add/drop mux/demux module in the west mux/demux slot; slot 4 uses the east line card motherboard, corresponding to the add/drop mux/demux module in the east mux/demux slot.

Figure 5-48 Shelf Configuration for Node 2 in Line Card Protected Meshed Ring



58321

Figure 5-49 shows how the 4-channel mux/demux modules are cabled for node 2 in the line card protected meshed ring.

Figure 5-49 Add/Drop Mux/Demux Module Cabling with OSC for Node 2 in Line Card Protected Meshed Ring

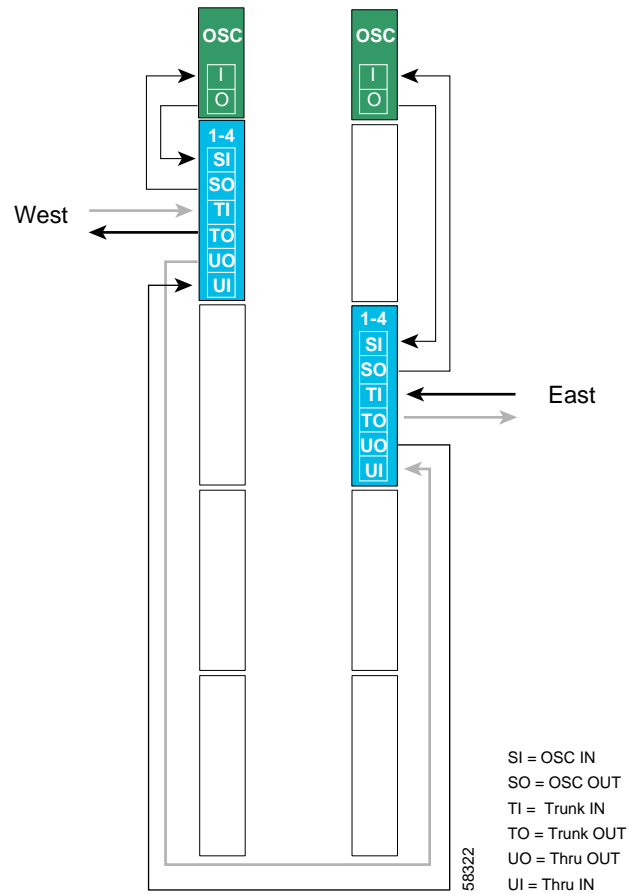

Figure 5-50 shows the shelf configuration for node 3 in the line card protected meshed ring. Slots 5 and 11 use the west line card motherboards, corresponding to the add/drop mux/demux modules in the west mux/demux slot; slots 3 and 9 use the east line card motherboards, corresponding to the add/drop mux/demux modules in the east mux/demux slot.

Figure 5-50 Shelf Configuration for Node 3 in Line Card Protected Meshed Ring

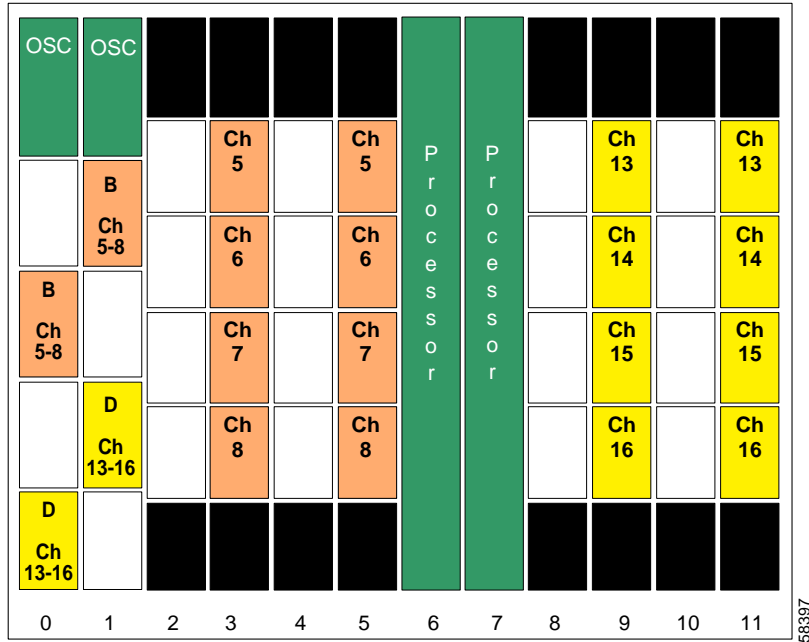

Figure 5-51 shows how the 4-channel mux/demux modules are cabled for the line card protected meshed ring.

Figure 5-51 Add/Drop Mux/Demux Module Cabling with OSC for Node 3 in Line Card Protected Meshed Ring

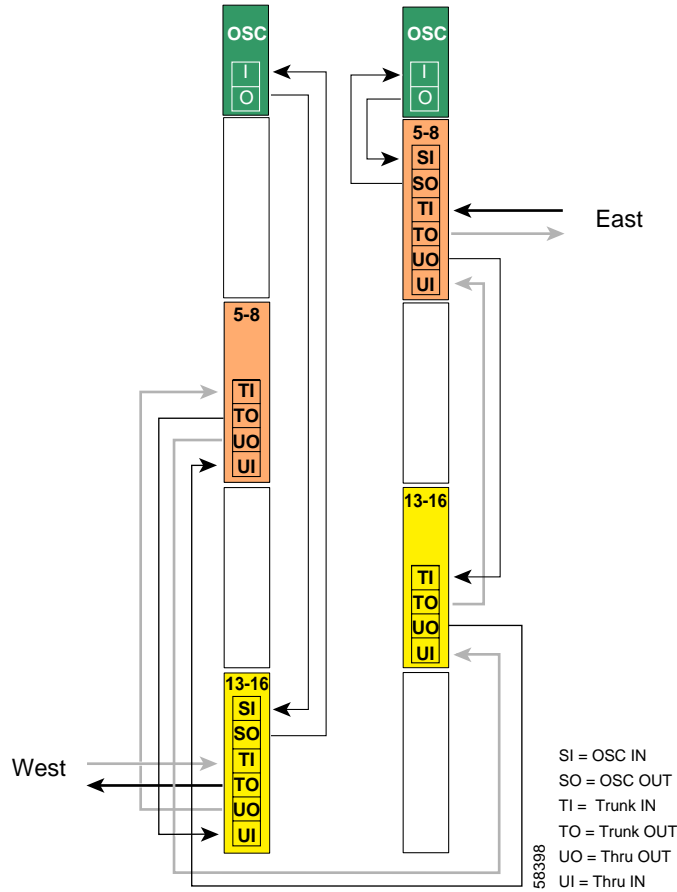

Figure 5-52 shows the shelf configuration for node 4 in the line card protected meshed ring. Slots 8 and 11 use the west line card motherboards, corresponding to the add/drop mux/demux modules in the west mux/demux slots; slots 9 and 10 use the east line card motherboards, corresponding to the add/drop mux/demux modules in the east mux/demux slots.

Figure 5-52 Shelf Configuration for Node 4 in Line Card Protected Meshed Ring

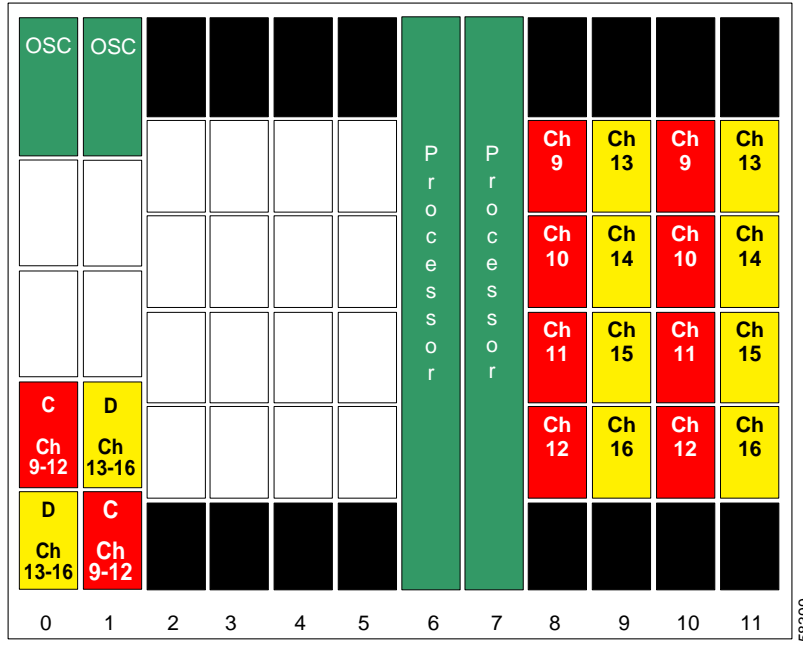
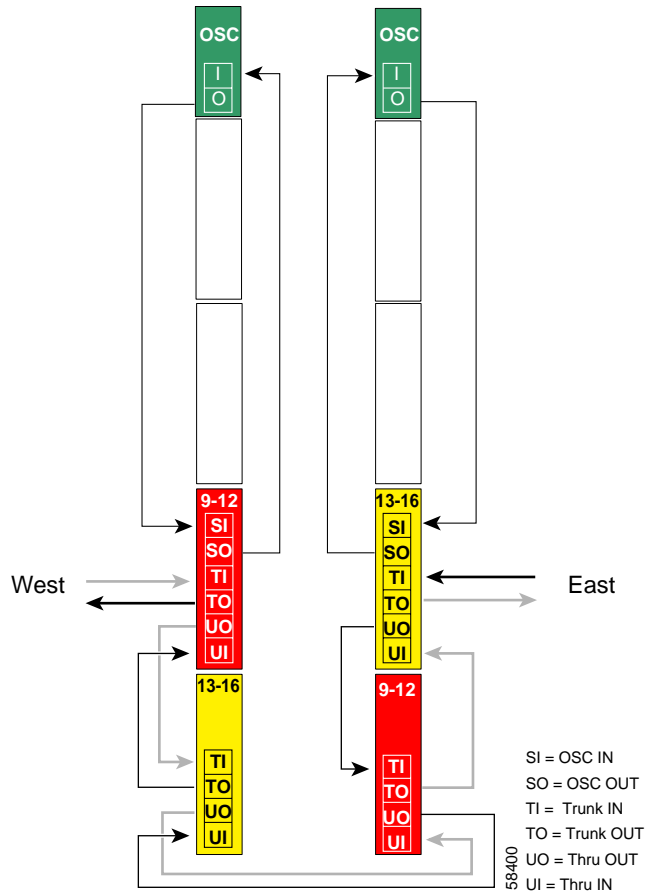

Figure 5-53 shows how the 4-channel mux/demux modules are cabled for node 4 in the line card protected meshed ring.

Figure 5-53 Add/Drop Mux/Demux Module Cabling with OSC for Node 4 in Line Card Protected Meshed Ring



Meshed Ring Topologies with Unprotected Channels

It is possible to configure a ring in which one or more bands are unprotected. If a splitter protected or line card protected ring topology has already been configured, adding unprotected channels is straightforward.

To add unprotected channels to an existing ring configuration, follow these steps:

-
- Step 1 Determine the nodes that will be logically connected by the unprotected channels.
 - Step 2 Determine the direction around the ring in which the unprotected channels will travel. This will determine whether an east or west line card motherboard should be used.
 - Step 3 Choose a channel band that is not already in use.
 - Step 4 Confirm that the shelf at both nodes can support the selected channel band.
-

Splitter Protected Meshed Ring with Unprotected Channels Configuration

Figure 5-54 uses the same channel plan as the 16-channel partial meshed ring example (see the “[Meshed Ring Topologies](#)” section on page 5-33), but adds an unprotected band between node 2 and node 3. The nodes communicate as follows:

- Nodes 1-2 over band A (path of greatest optical power loss, assuming equidistant nodes)
- Nodes 1-3 over band B
- Nodes 1-4 over band C
- Nodes 3-4 over band D
- Nodes 2-3 over band E (unprotected)

Figure 5-54 Channel Plan for Splitter Protected Meshed Ring with Unprotected Channels

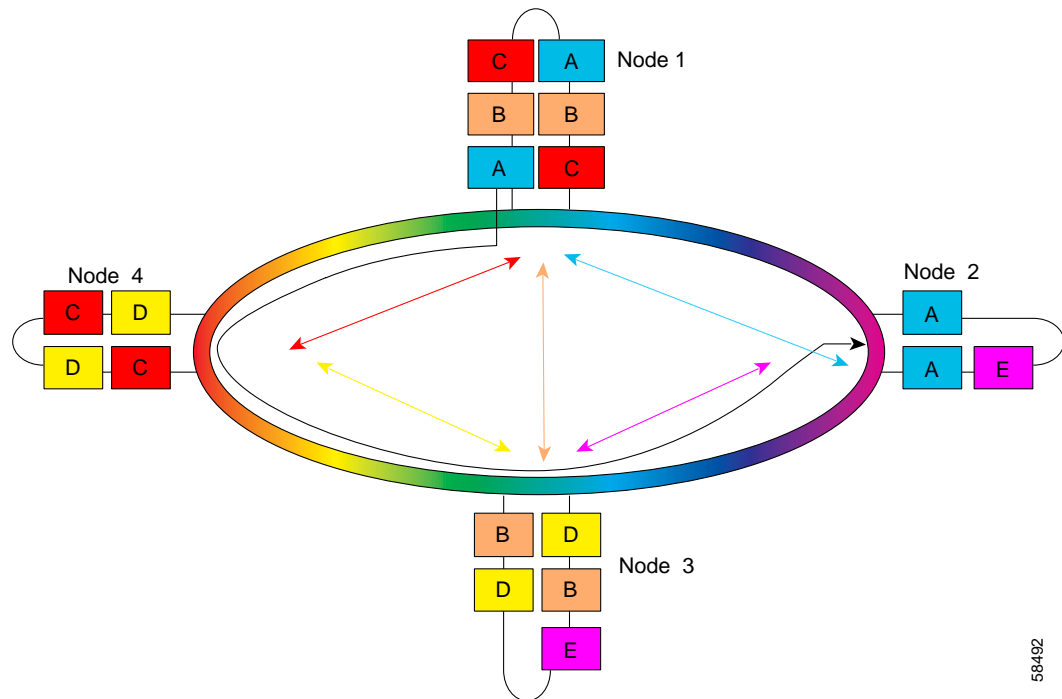

58492

Figure 5-55 shows the optical power loss for each of the components traversed by the channels in band A between node 1 and node 2 over node 4 and node 3, and for the OSC. All nodes use the 4-channel mux/demux modules. The splitter protected line card motherboards are used.

Figure 5-55 Optical Power Budget for Splitter Protected Meshed Ring with Unprotected Channels

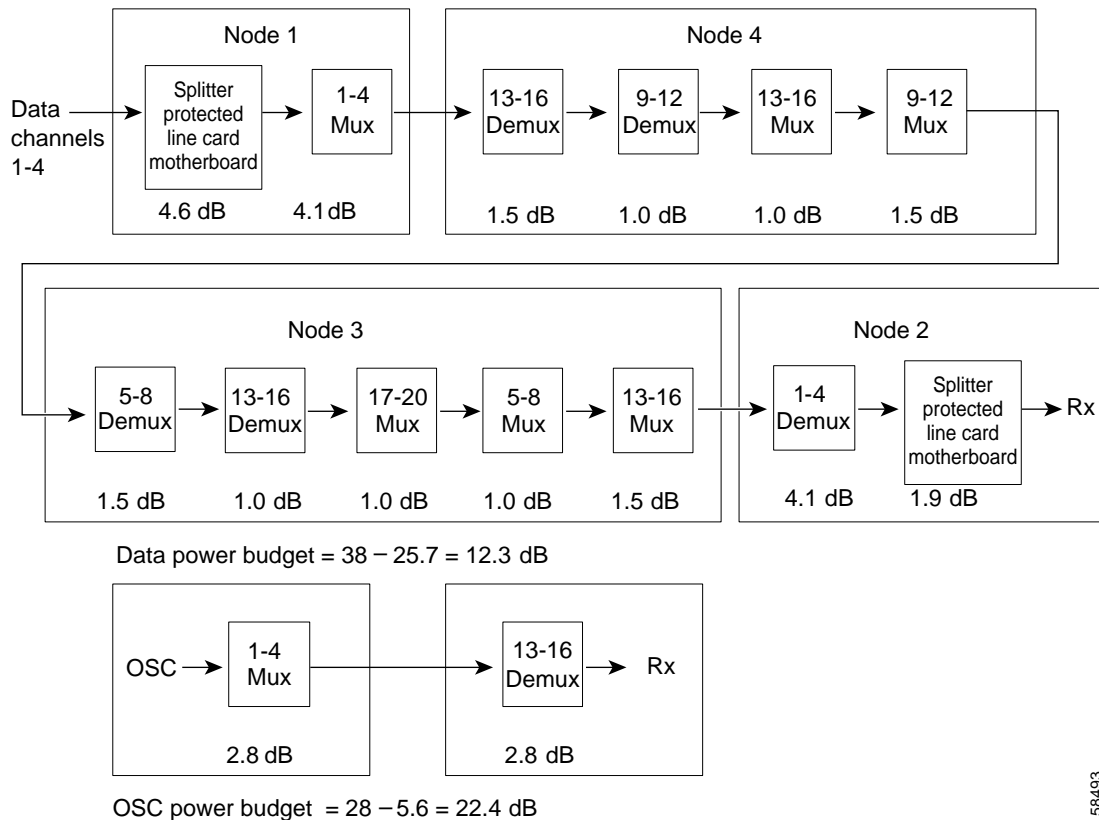

58493

The shelf configuration and optical mux/demux module cabling for node 1 and node 4 are the same as for the 16-channel partial meshed ring example with splitter protection. See the following figures for these configurations:

- Node 1 shelf configuration, [Figure 5-37 on page 5-36](#)
- Node 1 optical mux/demux module cabling, [Figure 5-38 on page 5-37](#)
- Node 4 shelf configuration, [Figure 5-43 on page 5-42](#)
- Node 4 optical mux/demux module cabling, [Figure 5-44 on page 5-43](#)

Figure 5-56 shows the shelf configuration for node 2 in the splitter protected meshed ring with unprotected channels. Slot 2 uses the splitter protected line card motherboard, which couples the signal to the add/drop mux/demux modules in subslot 0 of both west and east mux/demux slots. Slot 4, which supports the unprotected channels, uses an east line card motherboard.

Figure 5-56 Shelf Configuration for Node 2 in Splitter Protected Meshed Ring with Unprotected Channels

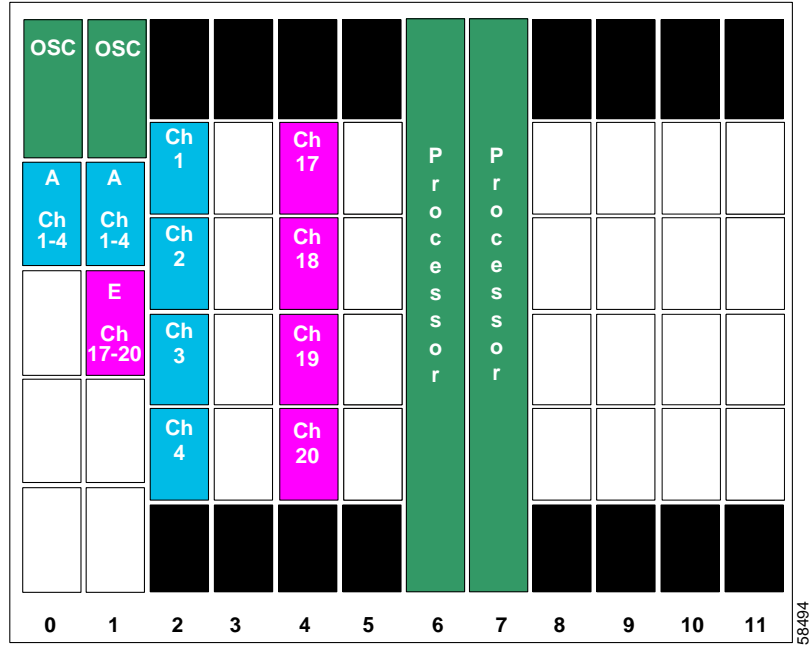

Figure 5-57 shows how the 4-channel mux/demux modules are cabled for node 2 in the splitter protected meshed ring with unprotected channels.

Figure 5-57 Add/Drop Mux/Demux Module Cabling for Node 2 in Splitter Protected Meshed Ring with Unprotected Channels

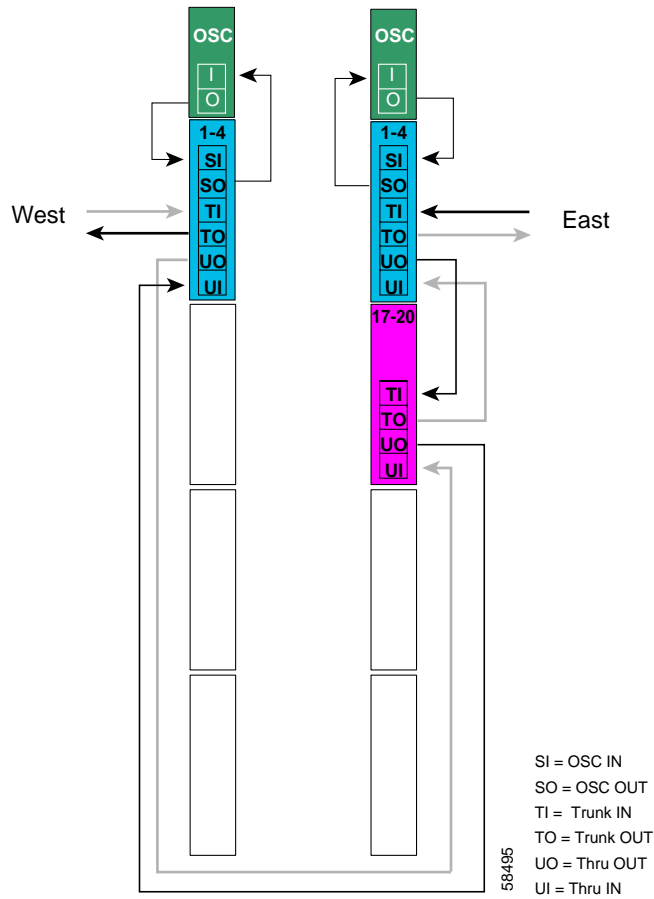

Figure 5-58 shows the shelf configuration for node 3 in the splitter protected meshed ring with unprotected channels. Slot 5 and slot 11 use splitter protected line card motherboards, which couple the signal to the add/drop mux/demux modules in subslot 1 and subslot 3, respectively, of both west and east mux/demux slots. Slot 8, which supports the unprotected channels, uses a west line card motherboard.

Figure 5-58 Shelf Configuration for Node 3 in Splitter Protected Meshed Ring with Unprotected Channels

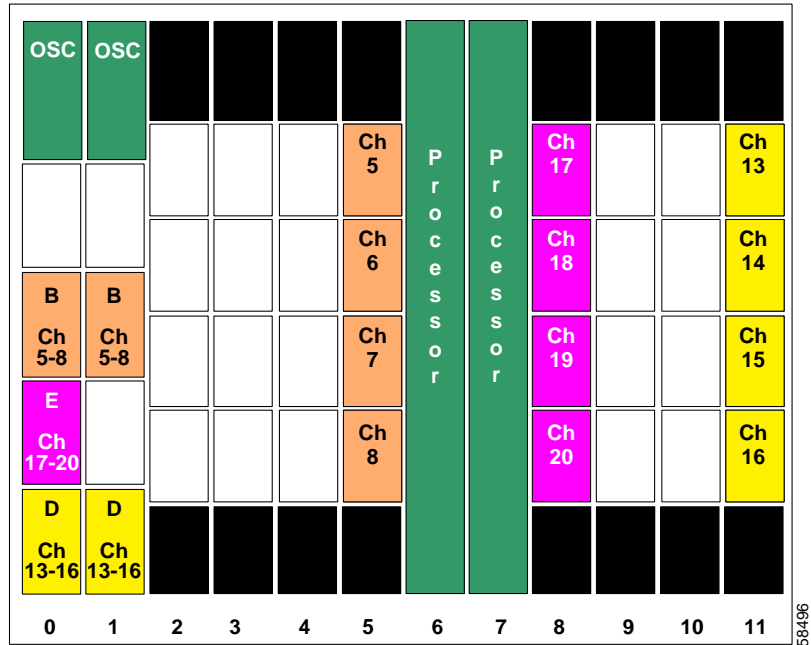
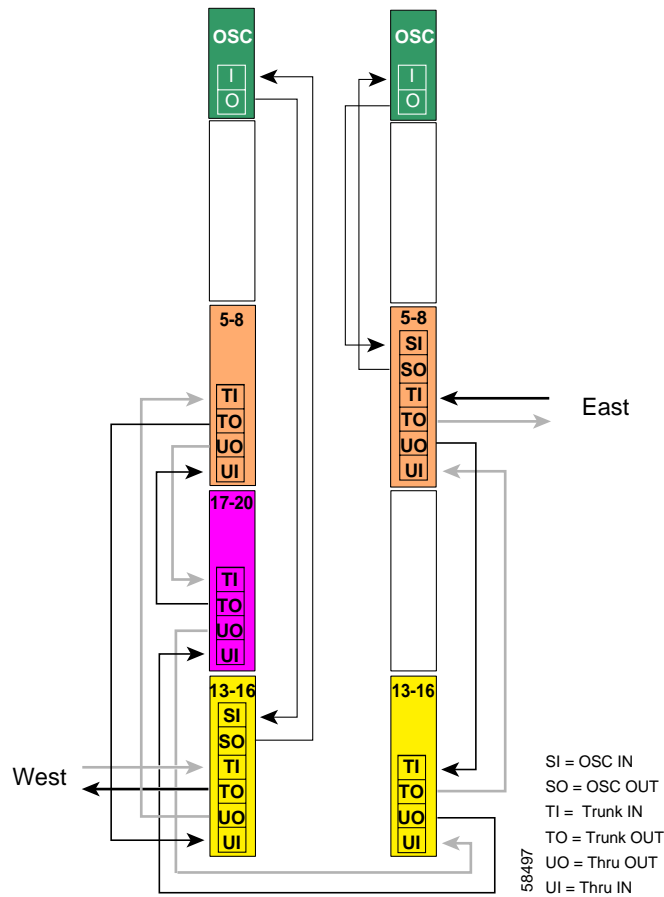

Figure 5-59 shows how the 4-channel mux/demux modules are cabled for node 3 in the splitter protected meshed ring with unprotected channels.

Figure 5-59 Add/Drop Mux/Demux Module Cabling for Node 3 in Splitter Protected Meshed Ring with Unprotected Channels



Line Card Protected Meshed Ring with Unprotected Channels Configuration

The topology and channel plan described in the “[Meshed Ring Topologies with Unprotected Channels](#)” section on page 5-52 and shown in [Figure 5-54 on page 5-53](#) can be configured with line card protection.

Figure 5-60 shows the optical power loss for each of the components traversed by the channels in band A between node 1 and node 2 over node 4 and node 3, and for the OSC. All nodes use the 4-channel mux/demux modules. The east and west line card motherboards are used.

Figure 5-60 Optical Power Budget for Line Card Protected Meshed Ring with Unprotected Channels

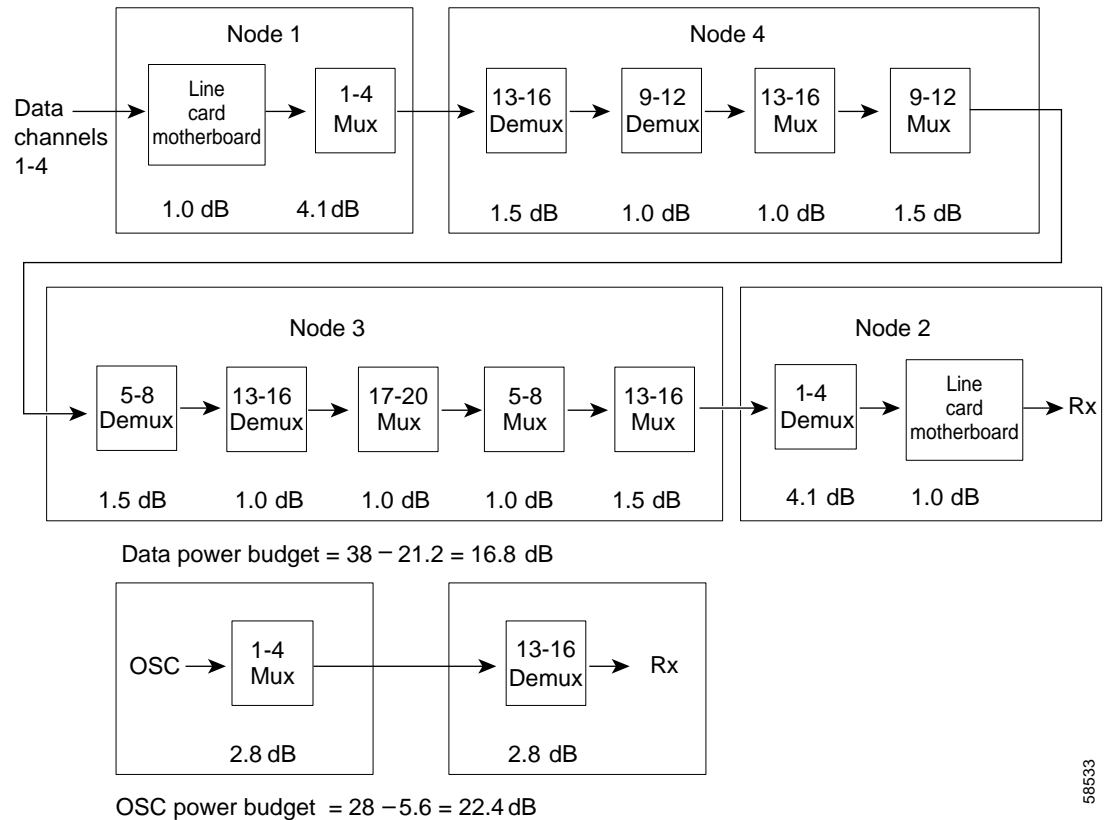

58533

The shelf configuration and optical mux/demux cabling for node 1 and node 4 are the same as for the 16-channel partial meshed ring example with line card protection. See the following figures for these configurations:

- Node 1 shelf configuration, [Figure 5-46 on page 5-45](#)
- Node 1 optical mux/demux module cabling, [Figure 5-47 on page 5-46](#)
- Node 4 shelf configuration, [Figure 5-52 on page 5-51](#)
- Node 4 optical mux/demux module cabling, [Figure 5-53 on page 5-52](#)

Figure 5-61 shows the shelf configuration for node 2 in the line card protected meshed ring with unprotected channels. Channels 1-4 are line card protected using a west line card motherboard in slot 2 and an east line card motherboard in slot 4. Slot 8 uses an east line card motherboard for the unprotected channels.

Figure 5-61 Shelf Configuration for Node 2 in Line Card Protected Meshed Ring with Unprotected Channels

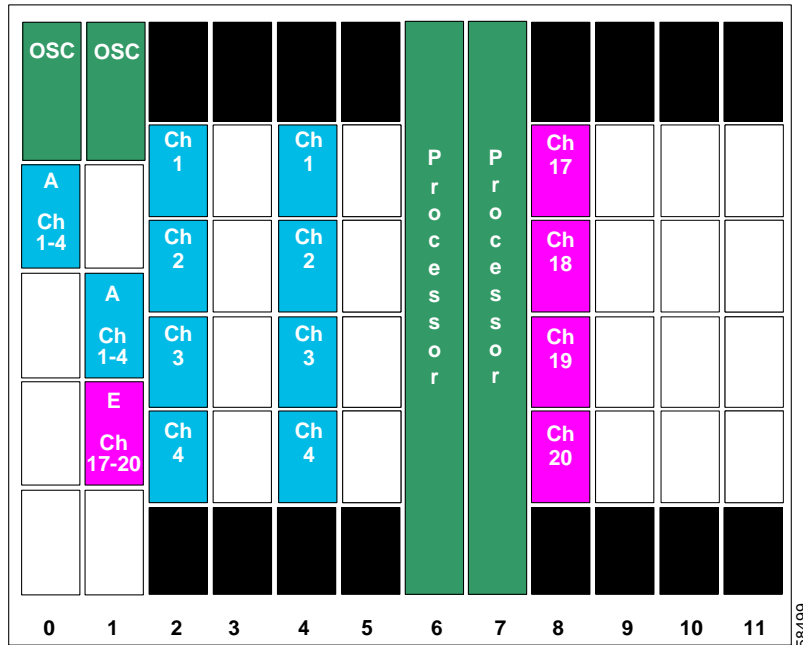

Figure 5-62 shows how the 4-channel mux/demux modules are cabled for node 2 in the line card protected meshed ring with unprotected channels.

Figure 5-62 Add/Drop Mux/Demux Module Cabling for Node 2 in Line Card Protected Meshed Ring with Unprotected Channels

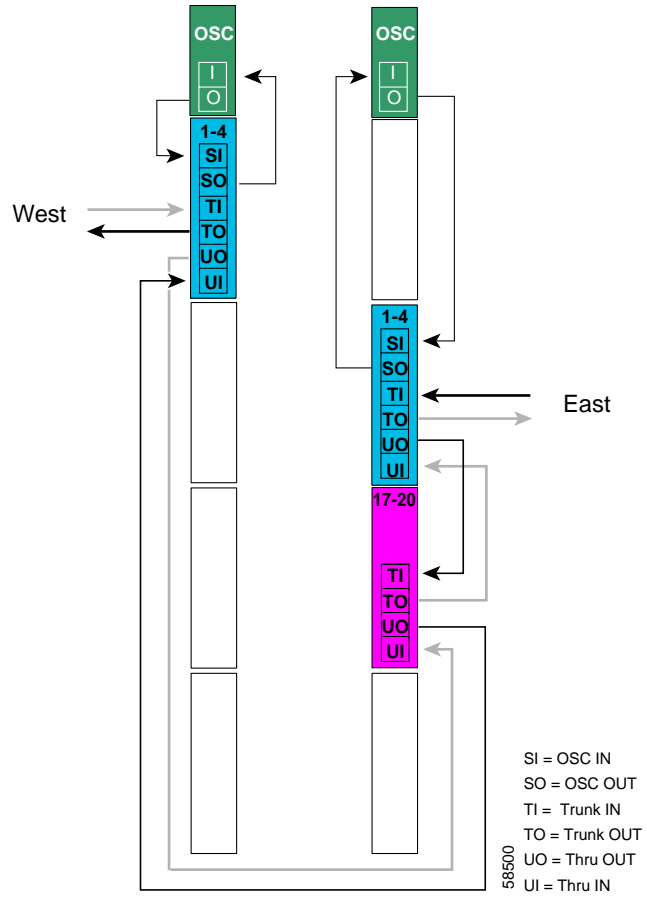

Figure 5-63 shows the shelf configuration for node 3 in the line card protected meshed ring with unprotected channels. Channels 5–8 are line card protected using an east line card motherboard in slot 3 and a west line card motherboard in slot 5. Channels 13–16 are line card protected using an east line card motherboard in slot 9 and a west line card motherboard in slot 11. Slot 8 uses a west line card motherboard for the unprotected channels.

Figure 5-63 Shelf Configuration for Node 3 in Line Card Protected Meshed Ring with Unprotected Channels

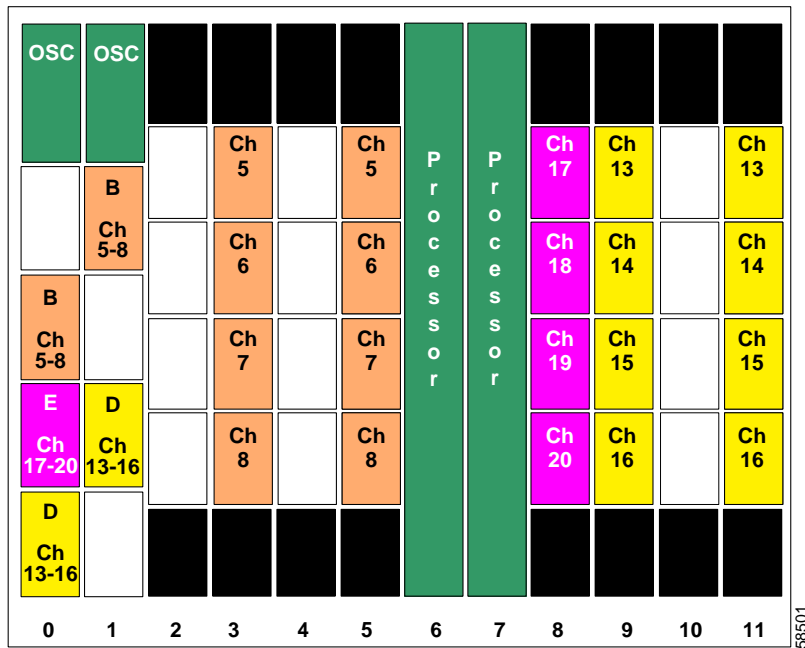
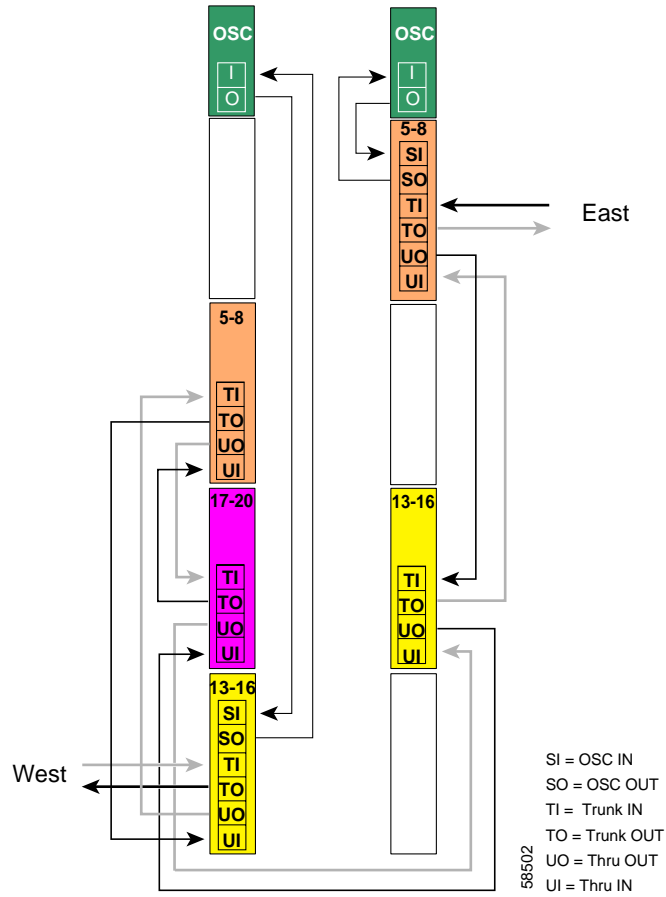

Figure 5-64 shows how the 4-channel mux/demux modules are cabled for node 3 in the line card protected meshed ring with unprotected channels.

Figure 5-64 Add/Drop Mux/Demux Module Cabling for Node 3 in Line Card Protected Meshed Ring with Unprotected Channels





IBM Storage Protocol Support

This appendix provides descriptions and design considerations for protocols used in an IBM storage environment. This appendix contains the following major sections:

- [Supported Protocols, page A-2](#)
- [Client Optical Power Budget and Attenuation Requirements, page A-4](#)

IBM Storage Environment

Figure A-1 shows a an IBM storage environment application with GDPS (Geographically Dispersed Parallel Sysplex). SANs (storage area networks) are attached to node 1 and node 2, and a LAN is attached to node 3.

Figure A-1 IBM Storage Environment with GDPS and DWDM

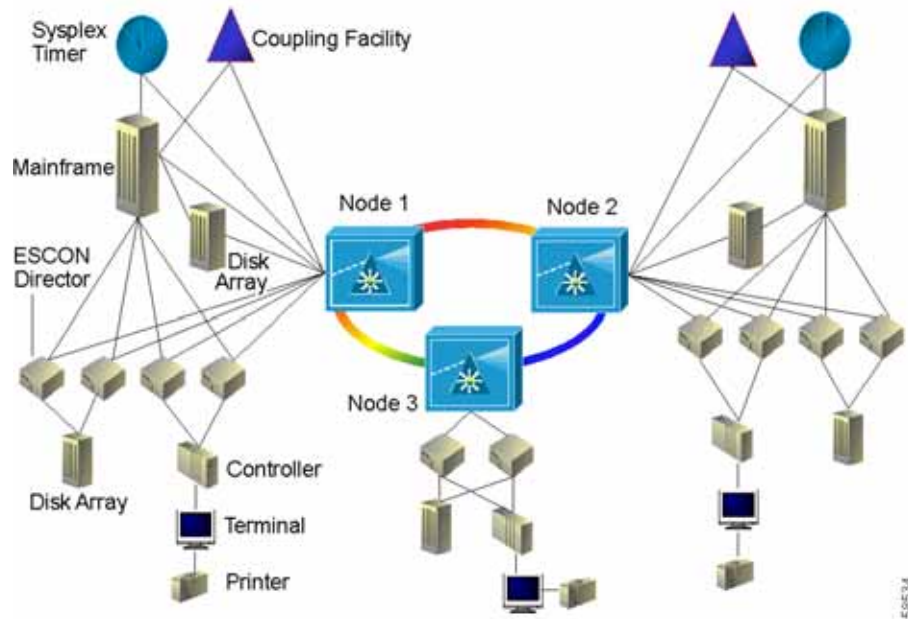

58534

Supported Protocols

The Cisco ONS 15540 can provide the transport layer for the following IBM storage related protocols:

- ESCON
- FICON
- Coupling Facility
- Sysplex Timer links

The Cisco ONS 15540 can also be used to help implement the high availability features for the following applications:

- PPRC
- XRC
- GDPS

ESCON

ESCON (Enterprise System Connection) is a 200-Mbps unidirectional serial bit transmission protocol used to dynamically connect mainframes with their various control units. ESCON provides nonblocking access through either point-to-point connections or high speed switches, called ESCON Directors. In the Parallel Sysplex or GDPS environment, ESCON performance is seriously affected if the distance spanned is greater than approximately 8 km. For instance, measurements have shown that ESCON performance at 20 km is roughly 50% of maximum performance. Performance degradation continues as distance is further increased.

[Figure A-2](#) shows an estimate of how the effective data rate decreases as the path length increases. At a distance of 9 km, performance begins to decrease precipitously. This data point is referred to as the *distance data rate droop point*.

Figure A-2 ESCON Data Rate as a Function of Distance

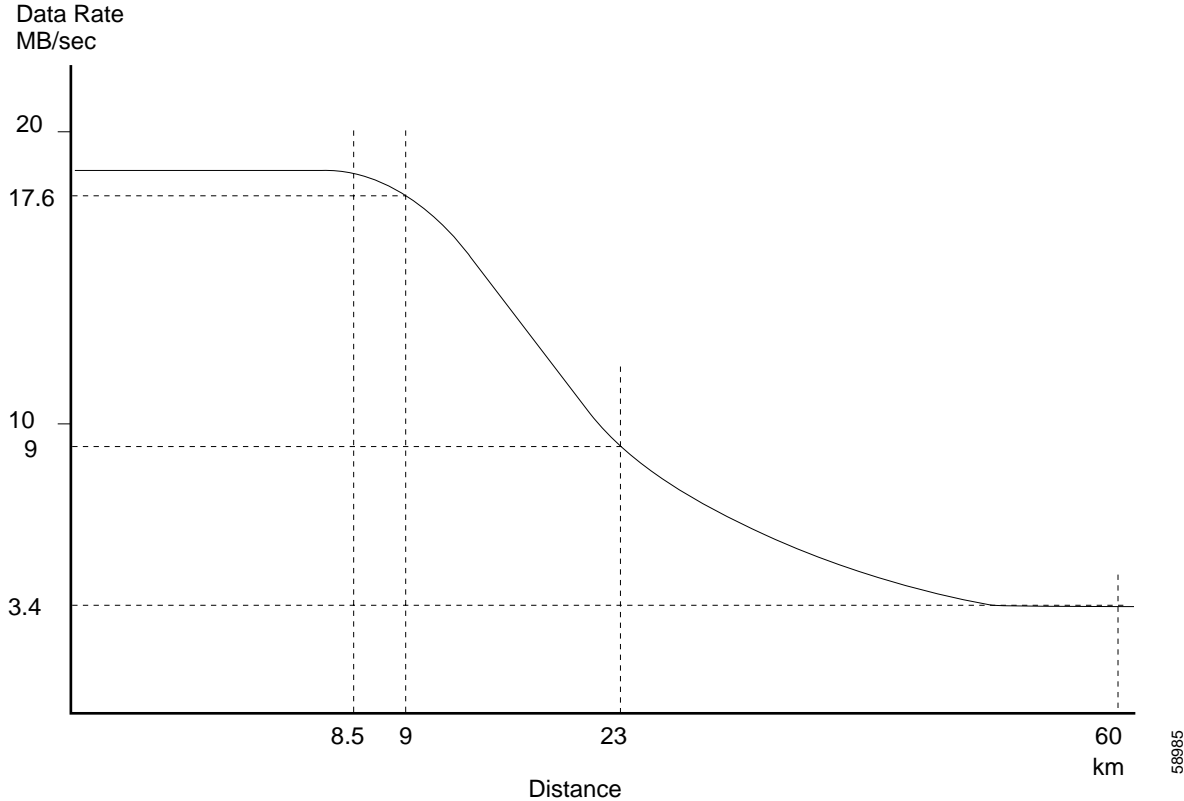

FICON

FICON (Fiber Connection) is the next generation bidirectional channel protocol used to connect mainframes directly with control units or ESCON aggregation switches (ESCON Directors with a bridge card). FICON runs over Fibre Channel at a data rate of 1.062 Gbps. One of the main advantages of FICON is the lack of performance degradation over distance that is seen with ESCON. FICON can reach a distance of 100 km before experiencing any significant drop in data throughput.

Coupling Facility

Coupling Facility (CF) links, also known as ISC (InterSystem Channel) links, are used to connect mainframes to a CF. The CF is used by multiple mainframes to share data in a sysplex or Parallel Sysplex environment. This data sharing capability is key to the high availability features of a GDPS. Coupling links run over Fibre Channel at data rates of 1.0625 Gbps (called ISC1 or ISC compatibility) and 2.1 Gbps (called ISC peer).

Sysplex Timer

Sysplex Timer links are the links used to provide the clock synchronization between the mainframes in a Parallel Sysplex. There are two types of links used. The first is the link between each mainframe and the Sysplex Timer, known as the ETR (external throughout rate) links. The second is the link between redundant Sysplex Timers, referred to as the CLO (control link oscillator) links. In a high availability GDPS environment, redundant Sysplex Timers are connected to each mainframe over ETR links, while the timers are connected to each other over the CLO links. This protocol operates at 16 Mbps.

PPRC

PPRC (peer-to-peer remote copy) is a facility used in certain IBM disk controllers that allows synchronous mirroring of data.

XRC

XRC (extended remote copy) is a facility used with certain IBM disk controllers that allows asynchronous mirroring of data.

GDPS

GDPS (Geographically Dispersed Parallel Sysplex) is a multisite parallel sysplex with sites up to 40 km apart. It uses custom automation to manage mirroring of critical data and to balance workload for regular use or for disaster recovery.

Client Optical Power Budget and Attenuation Requirements

Table A-1 shows the client optical power budget and attenuation requirements for the IBM storage protocols and IBM's implementation of other common protocols with high-end IBM servers that support ESCON, FICON, and Fibre Channel. For each protocol, the table shows the transmit power and receiver sensitivity ranges on the IBM server interface, the transponder type that supports this protocol on the Cisco ONS 15540, the resulting client loss budget, and what attenuation is required at 0 km. For the transmit powers and receiver sensitive ranges of the Cisco ONS 15540 transponder interfaces, refer to the [Cisco ONS 15540 ESP Hardware Installation Guide](#).

Table A-1 Optical Power Budget and Attenuation Requirements with High-End IBM Servers

Protocol	IBM Server Transmit (dBm)	IBM Server Receive (dBm)	Cisco ONS 15540 Transponder Type	Cisco ONS 15540 Client Loss Budget/Minimum Attenuation at 0 km
ESCON, SM	-3 to -8	-3 to -28	SM	Rx: 11 to 16 dB/none Tx: 23 to 28 dB/-3 dB
ESCON, MM ETR/CLO, MM	-15 to -20.5	-14 to -29	MM	Rx: 4.5 to 10 dB/none Tx: 24 to 29 dB/-14 dB
FICON, SM/LX	-4 to -8.5	-3 to -22	SM	Rx: 11.5 to 15 dB/none Tx: 17 to 22 dB/-3 dB
ATM 155, SM	-8 to -15	-8 to -32.5	SM	Rx: 4 to 11 dB/none Tx: 27.5 to 32.5 dB/-8 dB
ATM 155, MM	-14 to -19	-14 to -30	MM	Rx: 6 to 11 dB/none Tx: 25 to 30 dB/-14 dB
FDDI, MM	-14 to -19	-14 to -31.8	MM	Rx: 6 to 11 dB/none Tx: 26.8 to 31.8 dB/-14 dB
ISC, 1Gbps	-3 to -11	-3 to -20	SM	Rx: 8 to 16 dB/none Tx: 15 to 20 dB/-3 dB



Numerics

2.5-Gbps line card motherboards

- description [1-11](#)
- optical link loss [4-4](#)
- shelf configuration rules [3-12](#)

3R functions

- support for [1-4](#)
- transponders and [1-3](#)

4-channel mux/demux modules

- band pairings without splitter protection (table) [3-4](#)
- cabling rules [3-9](#)
- conflicting bands (table) [3-1](#)
- line card protection, example (figure) [3-4](#)
- optical link loss for data channels (table) [4-4](#)
- optical link loss for OSC (table) [4-5](#)
- shelf configuration rules without splitter protection [3-3](#)
- shelf configuration rules with splitter protection [3-2](#)
- transponder module placement with [3-5 to 3-7](#)
- See also add/drop mux/demux modules

8-channel mux/demux modules

- cabling rules [3-9](#)
- conflicting bands (table) [3-1](#)
- optical link loss for data channels (table) [4-4](#)
- optical link loss for OSC (table) [4-5](#)
- shelf configuration rules without splitter protection [3-4](#)
- shelf configuration rules with splitter protection [3-2](#)
- splitter protection example (figure) [3-3](#)
- transponder placement with [3-8 to 3-9](#)
- See also add/drop mux/demux modules

16-channel mux/demux modules

- cabling rules [3-12](#)
- optical link loss for data channels (table) [4-5](#)

- optical link loss for OSC (table) [4-5](#)
- shelf configuration rules [3-10](#)
- transponder module placement with [3-10 to 3-12](#)
- See also terminal mux/demux modules

A

add/drop mux/demux modules

- cascaded (figure) [1-14](#)
- cascaded in protected ring configurations (figure) [1-15](#)
- combining [1-13](#)
- description [1-12](#)
- logical view (figure) [1-13](#)
- physical layout [1-12](#)
- protected ring configurations (figure) [1-14](#)
- ring configurations [1-14](#)
- transponder placement with [3-5 to 3-8](#)
- See also 4-channel mux/demux modules; 8-channel mux/demux modules; mux/demux cabling; mux/demux modules

APS

- support for [1-2](#)

architecture

- description [1-3](#)
- figure [1-3](#)

ATM

- client equipment attenuation [A-4](#)
- client interface support [1-5](#)

attenuation

- ESCON and [A-4](#)
- line card motherboards [4-4](#)
- minimum for data channels [4-3](#)
- mux/demux modules [4-4](#)

Automatic Protection Switching. See APS

B

band allocation. See channel plans

bands

- add/drop mux/demux modules and [1-12](#)
- conflicting [3-1](#)
- mux/demux modules and [1-12](#)
- mux/demux module support (table) [1-12](#)
- terminal mux/demux modules and [1-13](#)

bidirectional path switching

- description [2-12](#)

bus topologies

- description [2-8](#)
- figure [2-8](#)

C

cabling. See mux/demux cabling

channel plans

- hubbed ring topologies, example [5-11](#)
- meshed ring topologies, example [5-34](#)
- meshed ring topologies with unprotected channels, example [5-53](#)

channels. See bands; data channels; OSC

chassis

- description [1-1](#)
- figure [1-2](#)
- optical backplane [2-3](#)

client protection

- description [2-6](#)
- implementation considerations [2-6](#)
- scheme (figure) [2-6](#)

client side interfaces

- encapsulation types [1-4](#)
- OFC [1-7](#)

components

- description [1-3 to 1-16](#)

Coupling Facility links

- client interface support [1-6](#)

description [A-3](#)

CPUs. See processor cards

D

data channels

- maximum number supported [1-2](#)
- optical link loss through 4-channel mux/demux modules [4-4](#)
- optical link loss through 8-channel mux/demux modules [4-4](#)
- optical link loss through 16-channel mux/demux modules [4-5](#)
- receiver sensitivity (table) [4-2](#)
- transmit power (table) [4-2](#)

dBs

- about [4-1](#)
- dBm [4-2](#)

decibels. See dBs

dense wavelength division multiplexing. See DWDM

documentation

- related [viii](#)

DS3

- client interface support [1-6](#)

dual shelf nodes

- configuring [5-8 to 5-10](#)

DWDM

- interfaces [1-2](#)

E

east/west motherboards. See line card motherboards

encapsulations [1-5](#)

Enterprise Systems Connection. See ESCON

ESCON

- client equipment attenuation [A-4](#)
- client interface support [1-5](#)
- client side attenuation [A-4](#)
- configuring protocol monitoring [1-9](#)

data rate as function of distance (figure) [A-3](#)
 extended range transponder modules
 description [1-7](#)
 extended remote copy. See XRC

F

Fast Ethernet
 client interface support [1-4](#)
 FDDI
 client equipment attenuation [A-4](#)
 client interface support [1-5](#)
 fiber
 testing requirements [4-5](#)
 Fiber Connection. See FICON
 fiber failure
 protection against [2-1](#)
 Fibre Channel
 autonegotiation support [1-7, 1-9, 1-10](#)
 client interface support [1-5](#)
 configuring protocol monitoring [1-9](#)
 FICON
 client equipment attenuation [A-4](#)
 client interface support [1-5](#)
 configuring protocol monitoring [1-9](#)
 description [A-3](#)

G

GDPS
 description [A-4](#)
 environment (figure) [A-1](#)
 Gigabit Ethernet
 client interface support [1-4](#)
 configuring protocol monitoring [1-9](#)

H

hubbed ring topologies
 configuring line card protection [5-22 to 5-33](#)
 configuring splitter protection [5-11 to 5-22](#)
 description [2-9](#)
 example (figure) [2-9](#)
 optical power budget with line card protection,
 example [5-23](#)
 optical power budget with splitter protection,
 example [5-12](#)

I

IBM protocols
 attenuation requirements [A-4](#)
 optical power budget [A-4](#)
 supported types [A-2 to A-4](#)
 interfaces
 processor [1-15](#)
 transponder [1-4](#)
 types [1-4](#)
 ISC compatibility
 client equipment attenuation [A-4](#)
 ITU-T G.692
 laser grid [1-2](#)

L

linear topologies. See bus topologies; point-to-point topologies
 line card motherboards
 description [1-11](#)
 optical link loss (table) [4-4](#)
 per shelf configuration rules [3-12, 3-13](#)
 line card protection
 client based [2-6](#)
 configuring hubbed ring topologies [5-22 to 5-33](#)
 configuring meshed ring topologies [5-44 to 5-52](#)

configuring meshed ring topologies with unprotected channels [5-58 to 5-63](#)

configuring point-to-point topologies [5-6 to 5-10](#)

y-cable based [2-4](#)

link loss. See optical link loss

logical mesh topologies. See meshed ring topologies

M

meshed ring topologies

adding unprotected channels [5-52](#)

configuring line card protection [5-44 to 5-52](#)

configuring line card protection with unprotected channels [5-58 to 5-63](#)

configuring splitter protection [5-35 to 5-43](#)

configuring splitter protection with unprotected channels [5-53 to 5-58](#)

description [2-10, 5-52](#)

example (figure) [2-10](#)

optical power budgets, examples [5-35, 5-44](#)

MM fiber. See multimode fiber

multimode fiber

other supported client signal encapsulations [1-6](#)

supported IBM storage protocols [1-5](#)

mux/demux cabling

description [3-9](#)

hubbed ring topologies with line card protection, example [5-25, 5-27, 5-29, 5-31, 5-33](#)

hubbed ring topologies with splitter protection, example [5-14, 5-16, 5-18, 5-20, 5-22](#)

meshed ring topologies with line card protection, example [5-46, 5-48, 5-49, 5-52](#)

meshed ring topologies with splitter protection, example [5-37, 5-39, 5-41, 5-43](#)

meshed ring topologies with unprotected channels, line card protection, example [5-61, 5-63](#)

meshed ring topologies with unprotected channels, splitter protection, example [5-56, 5-58](#)

point-to-point topologies with line card protection, 32 channels, example [5-10](#)

point-to-point topologies with line card protection, 16 channels, example [5-8](#)

point-to-point topologies without protection, example [5-4](#)

point-to-point topologies with splitter protection, example [5-6](#)

rules [3-9, 3-12](#)

mux/demux modules

bands supported [1-12](#)

configurations [1-13](#)

mapping to transponder modules (figure) [2-4](#)

meshed ring topologies and [5-34](#)

motherboards [1-11](#)

See also 4-channel mux/demux modules; 8-channel mux/demux modules; 16-channel mux/demux modules; add/drop mux/demux modules; mux/demux cabling; terminal mux/demux modules

N

network management

comparison (table) [1-17](#)

description [1-16](#)

NME

network management Ethernet

See NME

NME

description [1-17](#)

O

OC-1

client interface support [1-6](#)

OC-24

client interface support [1-6](#)

OFC

client signal encapsulation types supported [1-7](#)

open fiber control. See OFC

optical backplane

splitter protection and [2-3](#)

transponder to mux/demux module mapping (figure) [2-4](#)

transponder to mux/demux module mapping (table) [2-3](#)

optical link loss

- 2.5-Gbps line card motherboards [4-4](#)
- calculating [4-2](#)
- data channels [4-4](#)
- hubbed ring topologies with line card protection, example [5-23](#)
- hubbed ring topologies with splitter protection, example [5-12](#)
- meshed ring topologies and [5-34](#)
- meshed ring topologies with line card protection, example [5-44](#)
- meshed ring topologies with unprotected channels, line card protected, example [5-59](#)
- meshed ring topologies with unprotected channels, splitter protected, example [5-54](#)
- meshed ring with splitter protection, example [5-35](#)

OSC [4-5](#)

- point-to-point topologies with line card protection, example [5-7](#)
- point-to-point topologies without protection, example [5-2](#)
- point-to-point topologies with splitter protection, example [5-5](#)

See also optical power budgets

optical mux/demux modules. See mux/demux modules

optical power budgets

- overall [4-2](#)

See also optical link loss

optical power loss. See optical link loss

optical supervisory channel. See OSC

OSC

- description [1-11](#)
- information types [1-11](#)
- optical link loss through mux/demux modules [4-5](#)
- receiver sensitivity (table) [4-2](#)
- transmit power (table) [4-2](#)

P

Peer-to-Peer Remote Copy. See PPRC

point-to-point topologies

- configuring line card protection [5-6 to 5-10](#)
- configuring splitter protection [5-4 to 5-6](#)
- configuring without protection [5-2 to 5-4](#)
- description [2-7](#)
- equipment for [5-1](#)
- optical power budgets, example [5-2](#)
- optical power budgets, examples [5-5, 5-7](#)
- protection in [2-7](#)

power supplies

- description [1-1](#)

PPRC

- client interface support [A-2](#)
- description [A-4](#)

processor cards

- description [1-15](#)
- features [1-15](#)

processors. See processor cards

protection

- description [1-2](#)
- levels of [2-1](#)
- ring topologies [2-10](#)
- types [2-1 to 2-6](#)

See also APS; client protection; line card protection; splitter protection; y-cable protection

R

redundancy

- processor cards [1-16](#)

ring topologies

- protection in [2-10 to 2-12](#)
- shelf configuration rules [3-13](#)

See also hubbed ring topologies; meshed ring topologies

S

SANs

- IBM environment [A-1](#)

- SDH
 - client interface support [1-4](#)
 - configuring protocol monitoring [1-9](#)
 - security features
 - overview [1-16](#)
 - SFP optics
 - description [1-7](#)
 - shelf
 - configuration examples
 - hubbed ring topologies with line card protection [5-24](#), [5-26](#), [5-28](#), [5-30](#), [5-32](#)
 - hubbed ring topologies with splitter protection [5-13](#), [5-15](#), [5-17](#), [5-19](#), [5-21](#)
 - meshed ring topologies with line card protection [5-45](#), [5-47](#), [5-49](#), [5-51](#)
 - meshed ring topologies with splitter protection [5-36](#), [5-38](#), [5-40](#), [5-42](#)
 - meshed ring topologies with unprotected channels, line card protected [5-60](#), [5-62](#)
 - meshed ring topologies with unprotected channels, splitter protected [5-55](#), [5-57](#)
 - point-to-point topologies with line card protection, 32 channels [5-9](#)
 - point-to-point topologies with line card protection, 16 channels [5-7](#)
 - point-to-point topologies without protection [5-3](#)
 - point-to-point topologies with splitter protection [5-5](#)
 - configuration rules [3-1 to 3-13](#)
 - shelf configuration rules
 - 4-channel mux/demux modules [3-5 to 3-7](#)
 - 8-channel mux/demux modules [3-8 to 3-9](#)
 - 16-channel mux/demux modules [3-10 to 3-12](#)
 - ring topologies [3-13](#)
 - single-mode fiber
 - other supported client signal encapsulations [1-6](#)
 - supported IBM storage protocols [1-5](#)
 - slot mapping
 - transponder modules to 4-channel mux/demux modules [3-5](#)
 - transponder modules to 8-channel mux/demux modules [3-5](#)
 - transponder modules to 16-channel mux/demux modules [3-10](#)
 - SM fiber. See single-mode fiber
 - SONET
 - client interface support [1-4](#)
 - configuring protocol monitoring [1-9](#)
 - splitter motherboards. See line card motherboards
 - splitter protection
 - 4-channel mux/demux modules and [3-2](#)
 - 8-channel mux/demux modules and [3-2](#)
 - 16-channel mux/demux modules and [3-10](#)
 - configuring hubbed ring topologies [5-11 to 5-22](#)
 - configuring meshed ring topologies [5-35 to 5-43](#)
 - configuring meshed ring topologies with unprotected channels [5-53 to 5-58](#)
 - configuring point-to-point topologies [5-4 to 5-6](#)
 - considerations [2-2](#)
 - description [2-1](#)
 - optical backplane connections for [2-3](#)
 - scheme (figure) [2-2](#)
 - storage area networks
 - See SANs
 - Synchronous Digital Hierarchy. See SDH
 - Sysplex Timer
 - client interface support [1-6](#)
 - IBM storage environment and [A-3](#)
 - system
 - components [1-3 to 1-16](#)
 - functional overview [1-2](#)
 - system management
 - OSC and [1-11](#)
-
- T
 - terminal mux/demux modules
 - description [1-13](#)
 - optical link loss [1-13](#)
 - transponder placement with [3-10 to 3-12](#)
 - See also 16-channel mux/demux modules

theory of operation [1-2](#)

topologies. See bus topologies; hubbed ring topologies; meshed ring topologies; point-to-point topologies

transceivers. See SFP optics

transmitter launch power

- data channels [4-2](#)
- OSC [4-2](#)

transponder modules

- description [1-3](#)
- interfaces [1-4](#)
- line card motherboards [1-11](#)
- line card protection and [3-12, 3-13](#)
- mapping to mux/demux modules (figure) [2-4](#)
- placement for lower channels with 4-channel mux/demux modules [3-5 to 3-6](#)
- placement for upper channels with 4-channel mux/demux modules [3-6 to 3-7](#)
- placement with 8-channel mux/demux modules [3-8 to 3-9](#)
- placement with 16-channel mux/demux modules [3-11 to 3-12](#)

trunk side interfaces

- description [1-4](#)

U

Unidirectional Path Switched Ring. See UPSR

unidirectional path switching

- description [2-10](#)
- example (figure) [2-12](#)
- normal state (figure) [2-11](#)

unprotected channels

- adding [5-52](#)
- configuring in meshed ring topologies [5-53 to 5-63](#)

unprotected topologies. See point-to-point topologies

UPSR

- description [2-10](#)

X

XRC

- client interface support [A-2](#)
- description [A-4](#)

Y

y-cable protection

- considerations [2-5](#)
- description [2-4](#)

