



Fundamentals of DWDM Technology

The emergence of DWDM is one of the most recent and important phenomena in the development of fiber optic transmission technology. In the following discussion we briefly trace the stages of fiber optic technology and the place of DWDM in that development. We then examine the functions and components of a DWDM system, including the enabling technologies, and conclude with a high-level description of the operation of a DWDM system.

Evolution of Fiber Optic Transmission

The reality of fiber optic transmission had been experimentally proven in the nineteenth century, but the technology began to advance rapidly in the second half of the twentieth century with the invention of the fiberscope, which found applications in industry and medicine, such as in laparoscopic surgery.

After the viability of transmitting light over fiber had been established, the next step in the development of fiber optics was to find a light source that would be sufficiently powerful and narrow. The light-emitting diode (LED) and the laser diode proved capable of meeting these requirements. Lasers went through several generations in the 1960s, culminating with the semiconductor lasers that are most widely used in fiber optics today.

Light has an information-carrying capacity 10,000 times greater than the highest radio frequencies. Additional advantages of fiber over copper include the ability to carry signals over long distances, low error rates, immunity to electrical interference, security, and light weight.

Aware of these characteristics, researchers in the mid-1960s proposed that optical fiber might be a suitable transmission medium. There was an obstacle, however, and that was the loss of signal strength, or *attenuation*, seen in the glass they were working with. Finally, in 1970, Corning produced the first communication-grade fibers. With attenuation less than 20 decibels per kilometer (dB/km), this purified glass fiber exceeded the threshold for making fiber optics a viable technology.

Innovation at first proceeded slowly, as private and government monopolies that ran the telephone companies were cautious. AT&T first standardized transmission at DS3 speed (45 Mbps) for multimode fibers. Soon thereafter, single-mode fibers were shown to be capable of transmission rates 10 times that of the older type, as well as spans of 32 km (20 mi). In the early 1980s, MCI, followed by Sprint, adopted single-mode fibers for its long-distance network in the U.S.

Further developments in fiber optics are closely tied to the use of the specific regions on the optical spectrum where optical attenuation is low. These regions, called *windows*, lie between areas of high absorption. The earliest systems were developed to operate around 850 nm, the first window in silica-based optical fiber. A second window (S band), at 1310 nm, soon proved to be superior because

of its lower attenuation, followed by a third window (C band) at 1550 nm with an even lower optical loss. Today, a fourth window (L band) near 1625 nm is under development and early deployment. These four windows are shown relative to the electromagnetic spectrum in Figure 2-1.

Figure 2-1 Wavelength Regions

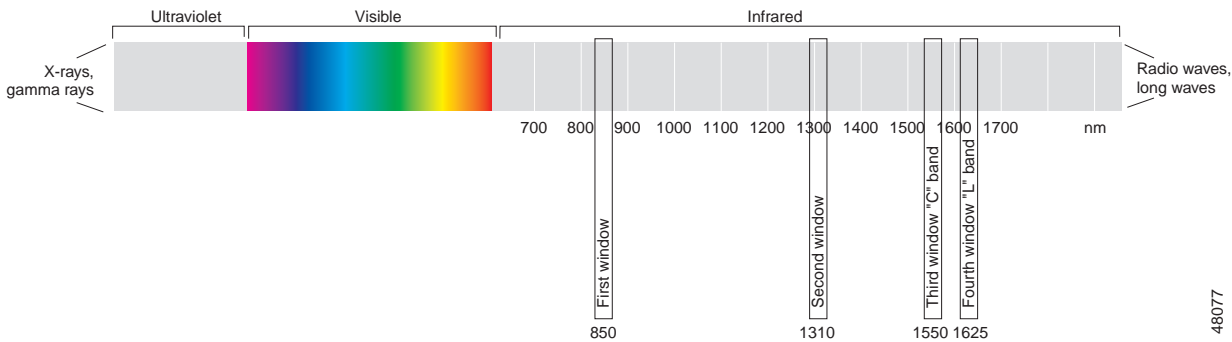

48077

Development of DWDM Technology

Early WDM began in the late 1980s using the two widely spaced wavelengths in the 1310 nm and 1550 nm (or 850 nm and 1310 nm) regions, sometimes called *wideband WDM*. Figure 2-2 shows an example of this simple form of WDM. Notice that one of the fiber pair is used to transmit and one is used to receive. This is the most efficient arrangement and the one most found in DWDM systems.

Figure 2-2 WDM with Two Channels

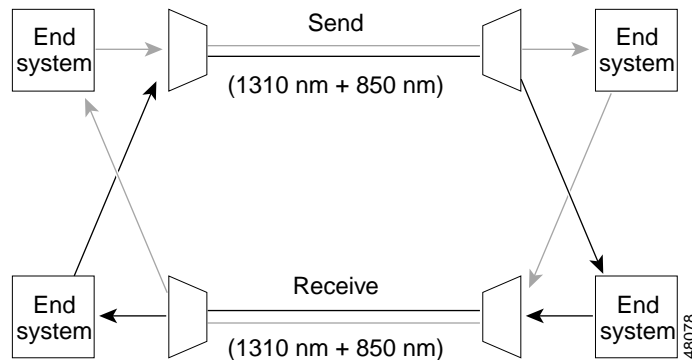

48078

The early 1990s saw a second generation of WDM, sometimes called *narrowband WDM*, in which two to eight channels were used. These channels were now spaced at an interval of about 400 GHz in the 1550-nm window. By the mid-1990s, dense WDM (DWDM) systems were emerging with 16 to 40 channels and spacing from 100 to 200 GHz. By the late 1990s DWDM systems had evolved to the point where they were capable of 64 to 160 parallel channels, densely packed at 50 or even 25 GHz intervals.

As Figure 2-3 shows, the progression of the technology can be seen as an increase in the number of wavelengths accompanied by a decrease in the spacing of the wavelengths. Along with increased density of wavelengths, systems also advanced in their flexibility of configuration, through add-drop functions, and management capabilities.

Figure 2-3 Evolution of DWDM

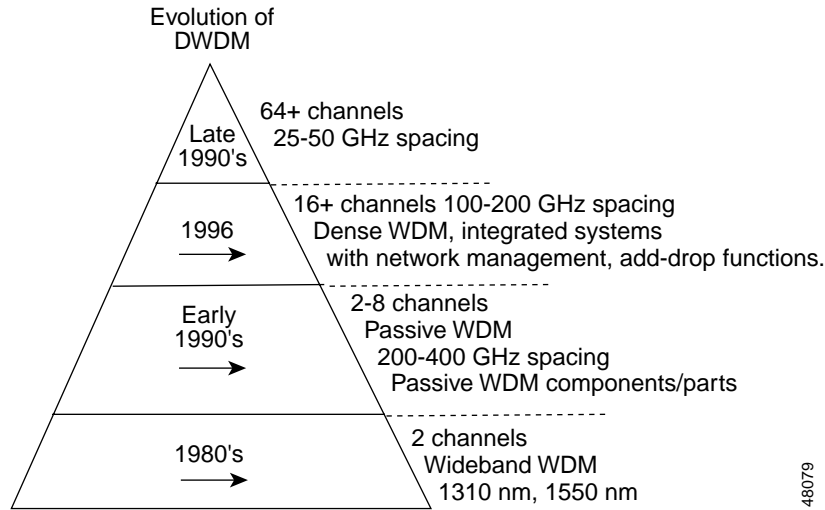

Increases in channel density resulting from DWDM technology have had a dramatic impact on the carrying capacity of fiber. In 1995, when the first 10 Gbps systems were demonstrated, the rate of increase in capacity went from a linear multiple of four every four years to four every year (see Figure 2-4).

Figure 2-4 Growth in Fiber Capacity

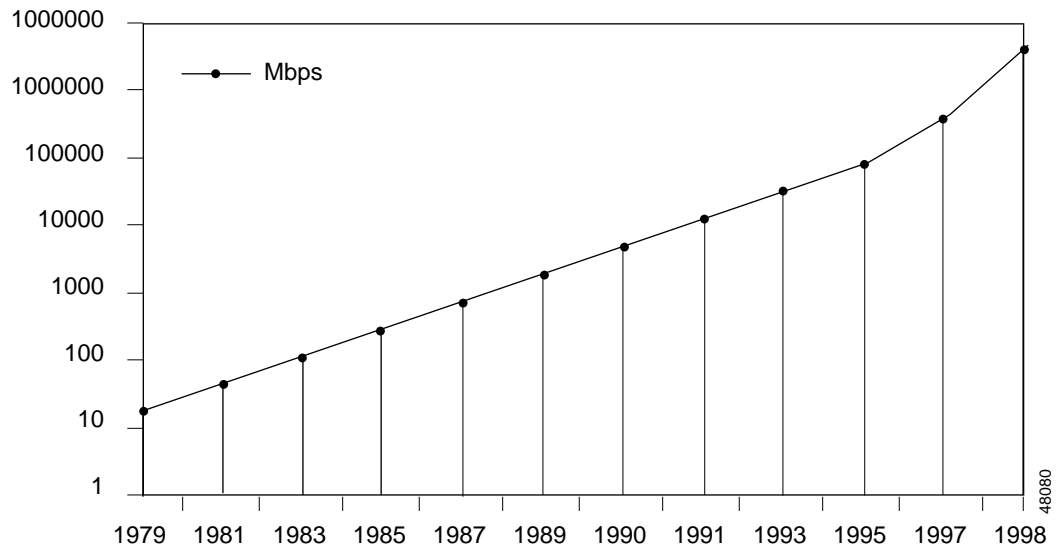

DWDM System Functions

At its core, DWDM involves a small number of physical-layer functions. These are depicted in Figure 2-5, which shows a DWDM schematic for four channels. Each optical channel occupies its own wavelength.

**Note**

Wavelength is expressed (usually in nanometers) as an absolute point on the electromagnetic spectrum. The effective light at a given wavelength is confined narrowly *around* its central wavelength.

Figure 2-5 DWDM Functional Schematic

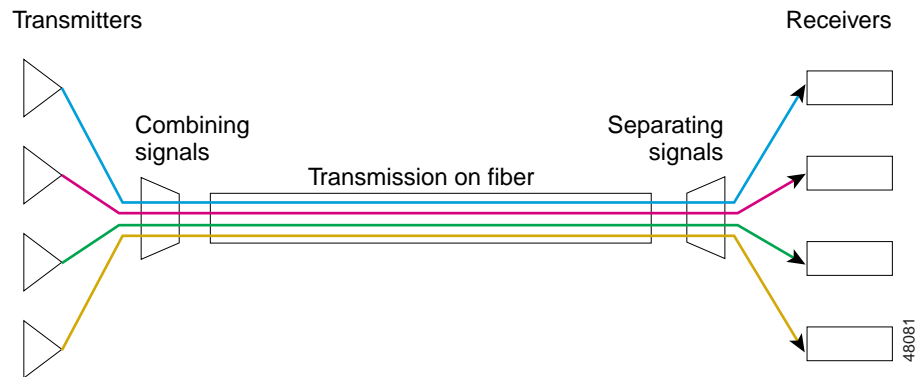

The system performs the following main functions:

- Generating the signal—The source, a solid-state laser, must provide stable light within a specific, narrow bandwidth that carries the digital data, modulated as an analog signal.
- Combining the signals—Modern DWDM systems employ multiplexers to combine the signals. There is some inherent loss associated with multiplexing and demultiplexing. This loss is dependent upon the number of channels but can be mitigated with optical amplifiers, which boost all the wavelengths at once without electrical conversion.
- Transmitting the signals—The effects of crosstalk and optical signal degradation or loss must be reckoned with in fiber optic transmission. These effects can be minimized by controlling variables such as channel spacings, wavelength tolerance, and laser power levels. Over a transmission link, the signal may need to be optically amplified.
- Separating the received signals—At the receiving end, the multiplexed signals must be separated out. Although this task would appear to be simply the opposite of combining the signals, it is actually more technically difficult.
- Receiving the signals—The demultiplexed signal is received by a photodetector.

In addition to these functions, a DWDM system must also be equipped with client-side interfaces to receive the input signal. This function is performed by transponders (see the [“Interfaces to DWDM”](#) section on page 2-20). On the DWDM side are interfaces to the optical fiber that links DWDM systems.

Enabling Technologies

Optical networking, unlike SONET/SDH, does not rely on electrical data processing. As such, its development is more closely tied to optics than to electronics. In its early form, as described previously, WDM was capable of carrying signals over two widely spaced wavelengths, and for a relatively short distance. To move beyond this initial state, WDM needed both improvements in existing technologies and invention of new technologies. Improvements in optical filters and narrowband lasers enabled

DWDM to combine more than two signal wavelengths on a fiber. The invention of the flat-gain optical amplifier, coupled in line with the transmitting fiber to boost the optical signal, dramatically increased the viability of DWDM systems by greatly extending the transmission distance.

Other technologies that have been important in the development of DWDM include improved optical fiber with lower loss and better optical transmission characteristics, EDFAs, and devices such as fiber Bragg gratings used in optical add/drop multiplexers.

Components and Operation

DWDM is a core technology in an optical transport network. The essential components of DWDM can be classified by their place in the system as follows:

- On the transmit side, lasers with precise, stable wavelengths
- On the link, optical fiber that exhibits low loss and transmission performance in the relevant wavelength spectra, in addition to flat-gain optical amplifiers to boost the signal on longer spans
- On the receive side, photodetectors and optical demultiplexers using thin film filters or diffractive elements
- Optical add/drop multiplexers and optical cross-connect components

These and other components, along with their underlying technologies, are discussed in the following sections. While much of this information, particularly the pros and cons of various competing technologies, may be of more importance to a system designer than to an end user or network designer, it may also be of interest to other readers. Note as well that this is summary information and is not intended to be complete or authoritative. For in-depth information on components and underlying technologies, refer to the sources cited in the “Additional Reading” section on page vii.

Optical Fibers

The following discussion of DWDM components and technologies includes a refresher on optical fibers, with emphasis on their application for DWDM. Background information on subjects such as the properties of light and optical theory can be found in many readily available printed sources and online, for example, in the tutorial at <http://www.vislab.usyd.edu.au/phonics/fibres/index.html>.

How Fiber Works

The main job of optical fibers is to guide lightwaves with a minimum of attenuation (loss of signal). Optical fibers are composed of fine threads of glass in layers, called the core and cladding, that can transmit light at about two-thirds the speed of light in a vacuum. Though admittedly an oversimplification, the transmission of light in optical fiber is commonly explained using the principle of *total internal reflection*. With this phenomenon, 100 percent of light that strikes a surface is reflected. By contrast, a mirror reflects about 90 percent of the light that strikes it.

Light is either reflected (it bounces back) or refracted (its angle is altered while passing through a different medium) depending upon the angle of incidence (the angle at which light strikes the interface between an optically denser and optically thinner material).

Total internal reflection happens when the following conditions are met:

- Beams pass from a more dense to a less dense material. The difference between the optical density of a given material and a vacuum is the material's refractive index.

- The incident angle is less than the critical angle. The critical angle is the angle of incidence at which light stops being refracted and is instead totally reflected.

The principle of total internal reflection within a fiber core is illustrated in [Figure 2-6](#). The core has a higher refractive index than the cladding, allowing the beam that strikes that surface at less than the critical angle to be reflected. The second beam does not meet the critical angle requirement and is refracted.

Figure 2-6 Principle of Total Internal Reflection

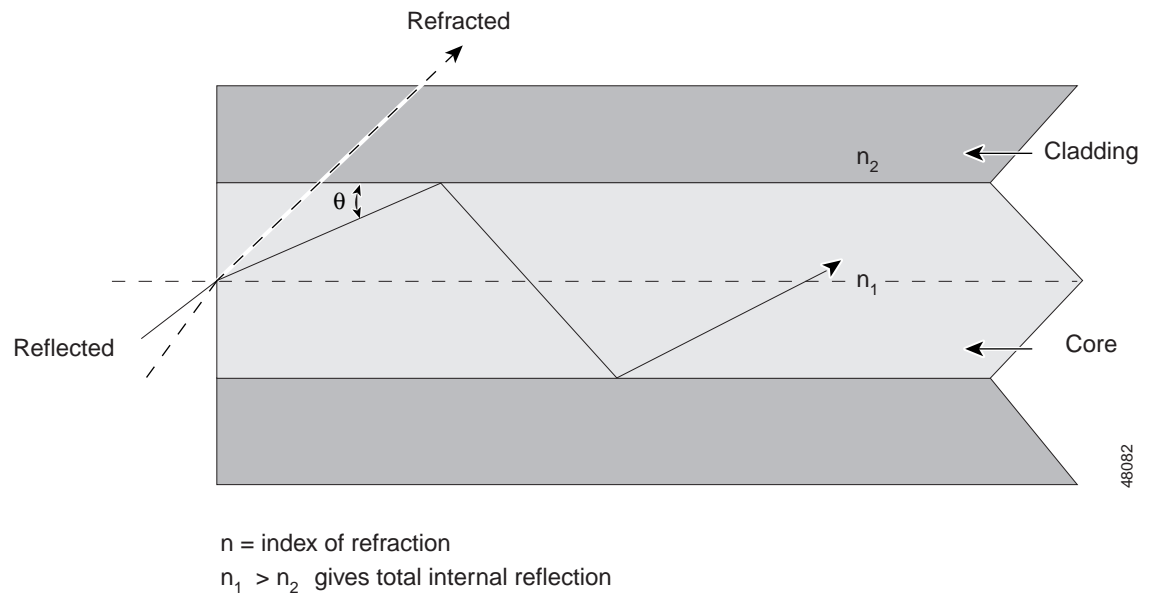

An optical fiber consists of two different types of highly pure, solid glass (silica)—the *core* and the *cladding*—that are mixed with specific elements, called *dopants*, to adjust their refractive indices. The difference between the refractive indices of the two materials causes most of the transmitted light to bounce off the cladding and stay within the core. The critical angle requirement is met by controlling the angle at which the light is injected into the fiber. Two or more layers of protective coating around the cladding ensure that the glass can be handled without damage.

Multimode and Single-Mode Fiber

There are two general categories of optical fiber in use today, multimode fiber and single-mode fiber. Multimode, the first type of fiber to be commercialized, has a larger core than single-mode fiber. It gets its name from the fact that numerous *modes*, or light rays, can be carried simultaneously through the waveguide. [Figure 2-7](#) shows an example of light transmitted in the first type of multimode fiber, called *step-index*. Step-index refers to the fact that there is a uniform index of refraction throughout the core; thus there is a step in the refractive index where the core and cladding interface. Notice that the two modes must travel different distances to arrive at their destinations. This disparity between the times that the light rays arrive is called *modal dispersion*. This phenomenon results in poor signal quality at the receiving end and ultimately limits the transmission distance. This is why multimode fiber is not used in wide-area applications.

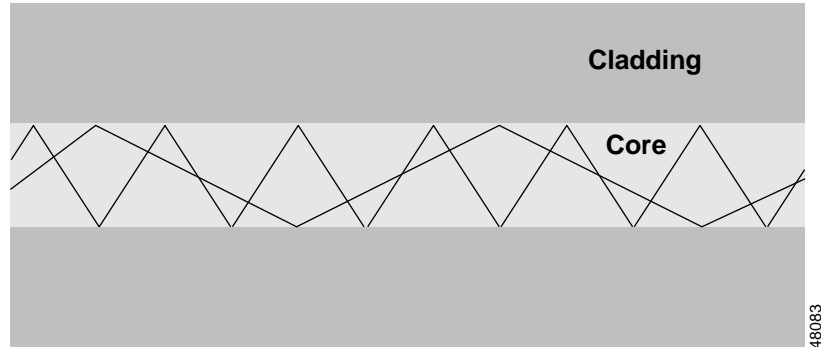
Figure 2-7 *Reflected Light in Step-Index Multimode Fiber*

To compensate for the dispersion drawback of step-index multimode fiber, graded-index fiber was invented. *Graded-index* refers to the fact that the refractive index of the core is graded—it gradually decreases from the center of the core outward. The higher refraction at the center of the core slows the speed of some light rays, allowing all the rays to reach their destination at about the same time and reducing modal dispersion.

The second general type of fiber, single-mode, has a much smaller core that allows only one mode of light at a time through the core (see [Figure 2-8](#)). As a result, the fidelity of the signal is better retained over longer distances, and modal dispersion is greatly reduced. These factors attribute to a higher bandwidth capacity than multimode fibers are capable of. For its large information-carrying capacity and low intrinsic loss, single-mode fibers are preferred for longer distance and higher bandwidth applications, including DWDM.

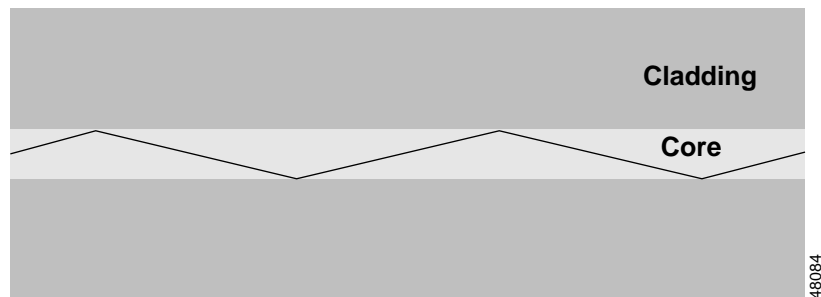
Figure 2-8 *Reflected Light in Single-Mode Fiber*

Single-Mode Fiber Designs

Designs of single-mode fiber have evolved over several decades. The three principle types and their ITU-T specifications are:

- Non-dispersion-shifted fiber (NDSF), G.652
- Dispersion-shifted fiber (DSF), G.653
- Non-zero dispersion-shifted fiber (NZ-DSF), G.655

As discussed earlier, and shown in [Figure 2-1](#), there are four windows within the infrared spectrum that have been exploited for fiber transmission. The first window, near 850 nm, was used almost exclusively for short-range, multimode applications. Non-dispersion-shifted fibers, commonly called standard

single-mode (SM) fibers, were designed for use in the second window, near 1310 nm. To optimize the fiber's performance in this window, the fiber was designed so that chromatic dispersion would be close to zero near the 1310-nm wavelength.

As optical fiber use became more common and the needs for greater bandwidth and distance increased, a third window, near 1550 nm, was exploited for single-mode transmission. The third window, or C band, offered two advantages: it had much lower attenuation, and its operating frequency was the same as that of the new erbium-doped fiber amplifiers (EDFAs). However, its dispersion characteristics were severely limiting. This was overcome to a certain extent by using narrower linewidth and higher power lasers. But because the third window had lower attenuation than the 1310-nm window, manufacturers came up with the dispersion-shifted fiber design, which moved the zero-dispersion point to the 1550-nm region. Although this solution now meant that the lowest optical attenuation and the zero-dispersion points coincided in the 1550-nm window, it turned out that there are destructive nonlinearities in optical fiber near the zero-dispersion point for which there is no effective compensation. Because of this limitation, these fibers are not suitable for DWDM applications.

The third type, non-zero dispersion-shifted fiber, is designed specifically to meet the needs of DWDM applications. The aim of this design is to make the dispersion low in the 1550-nm region, but not zero. This strategy effectively introduces a controlled amount of dispersion, which counters nonlinear effects such as four-wave mixing (see the “[Other Nonlinear Effects](#)” section on page 2-11) that can hinder the performance of DWDM systems.

Transmission Challenges

Transmission of light in optical fiber presents several challenges that must be dealt with. These fall into the following three broad categories:

- Attenuation—decay of signal strength, or loss of light power, as the signal propagates through the fiber
- Chromatic dispersion—spreading of light pulses as they travel down the fiber
- Nonlinearities—cumulative effects from the interaction of light with the material through which it travels, resulting in changes in the lightwave and interactions between lightwaves

Each of these effects has several causes, not all of which affect DWDM. The discussion in the following sections addresses those causes that are relevant to DWDM.

Attenuation

Attenuation in optical fiber is caused by intrinsic factors, primarily scattering and absorption, and by extrinsic factors, including stress from the manufacturing process, the environment, and physical bending. The most common form of scattering, *Rayleigh scattering*, is caused by small variations in the density of glass as it cools. These variations are smaller than the wavelengths used and therefore act as scattering objects (see [Figure 2-9](#)). Scattering affects short wavelengths more than long wavelengths and limits the use of wavelengths below 800 nm.

Figure 2-9 Rayleigh Scattering

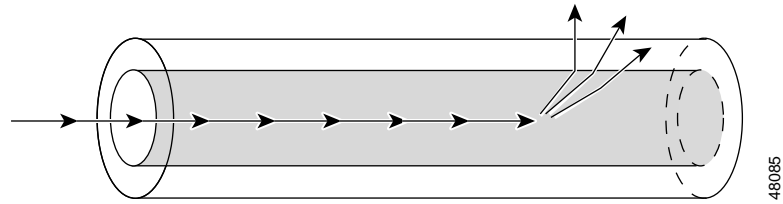

Attenuation due to absorption is caused by the intrinsic properties of the material itself, the impurities in the glass, and any atomic defects in the glass. These impurities absorb the optical energy, causing the light to become dimmer (see Figure 2-10). While Rayleigh scattering is important at shorter wavelengths, intrinsic absorption is an issue at longer wavelengths and increases dramatically above 1700 nm. However, absorption due to water peaks introduced in the fiber manufacturing process are being eliminated in some new fiber types.

Figure 2-10 Absorption

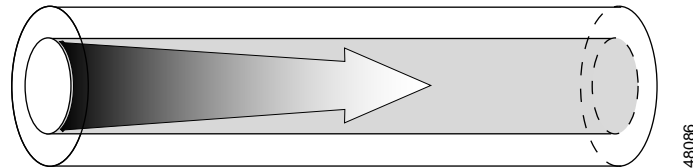

The primary factors affecting attenuation in optical fibers are the length of the fiber and the wavelength of the light. Figure 2-11 shows the loss in decibels per kilometer (dB/km) by wavelength from Rayleigh scattering, intrinsic absorption, and total attenuation from all causes.

Figure 2-11 Total Attenuation Curve

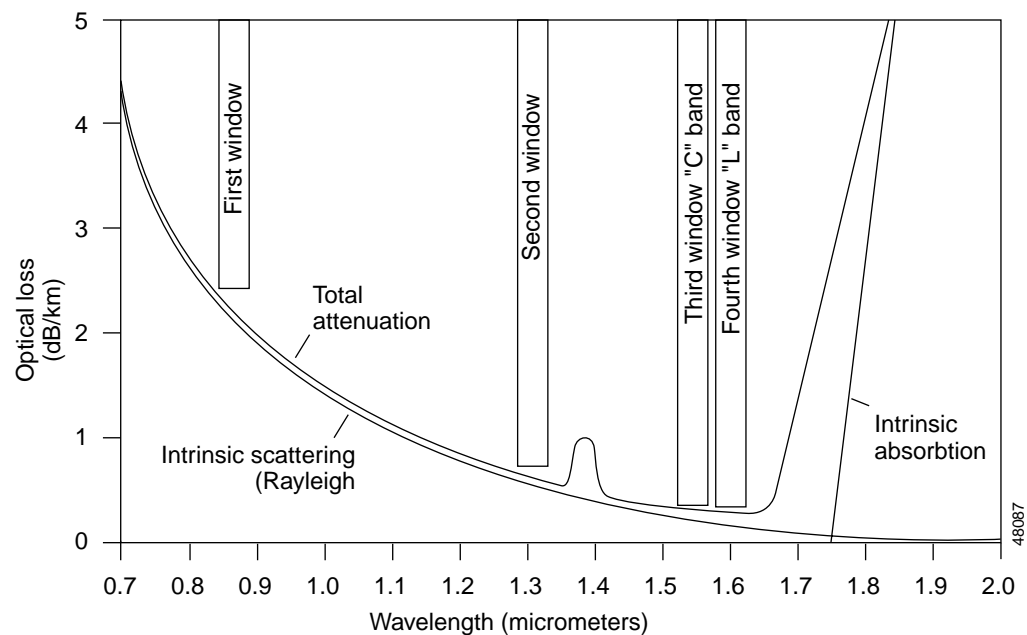

Attenuation in fiber is compensated primarily through the use of optical amplifiers, as described in the “Optical Amplifiers” section on page 2-15.

Dispersion

Dispersion is the spreading of light pulses as they travel down optical fiber. Dispersion results in distortion of the signal (see Figure 2-12), which limits the bandwidth of the fiber.

Figure 2-12 Principle of Dispersion

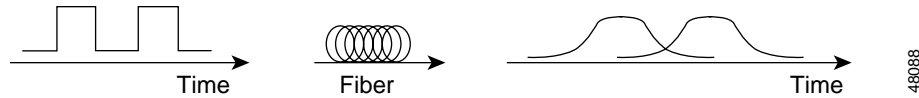

Two general types of dispersion affect DWDM systems. One of these effects, chromatic dispersion, is linear while the other, polarization mode dispersion (PMD), is nonlinear.

Chromatic Dispersion

Chromatic dispersion occurs because different wavelengths propagate at different speeds. The effect of chromatic dispersion increases as the square of the bit rate. In single-mode fiber, chromatic dispersion has two components, material dispersion and waveguide dispersion.

Material dispersion occurs when wavelengths travel at different speeds through the material. A light source, no matter how narrow, emits several wavelengths within a range. Thus, when this range of wavelengths travels through a medium, each individual wavelength arrives at a different time.

The second component of chromatic dispersion, waveguide dispersion, occurs because of the different refractive indices of the core and the cladding of fiber. The effective refractive index varies with wavelength as follows:

- At short wavelengths, the light is well confined within the core. Thus the effective refractive index is close to the refractive index of the core material.
- At medium wavelengths, the light spreads slightly into the cladding. This decreases the effective refractive index.
- At long wavelengths, much of the light spreads into the cladding. This brings the effective refractive index very close to that of the cladding.

This result of the phenomenon of waveguide dispersion is a propagation delay in one or more of the wavelengths relative to others.

Total chromatic dispersion, along with its components, is plotted by wavelength in Figure 2-13 for dispersion-shifted fiber. For non-dispersion-shifted fiber, the zero dispersion wavelength is 1310 nm.

Figure 2-13 Chromatic Dispersion

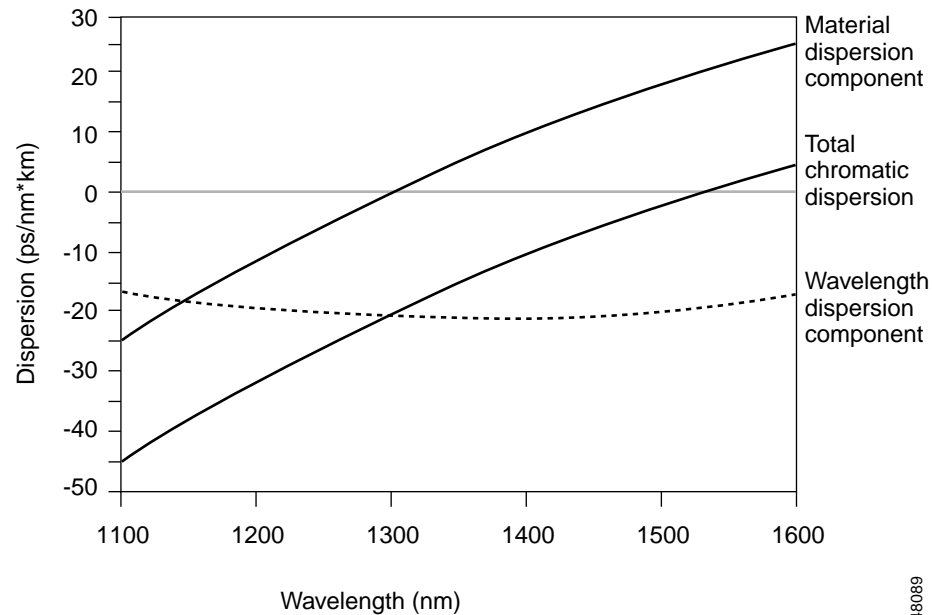

Though chromatic dispersion is generally not an issue at speeds below OC-48, it does increase with higher bit rates due to the spectral width required. New types of zero-dispersion-shifted fibers greatly reduce these effects. The phenomenon can also be mitigated with dispersion compensators.

Polarization Mode Dispersion

Most single-mode fibers support two perpendicular polarization modes, a vertical one and a horizontal one. Because these polarization states are not maintained, there occurs an interaction between the pulses that results in a smearing of the signal.

Polarization mode dispersion (PMD) is caused by ovality of the fiber shape as a result of the manufacturing process or from external stressors. Because stress can vary over time, PMD, unlike chromatic dispersion, is subject to change over time. PMD is generally not a problem at speeds below OC-192.

Other Nonlinear Effects

In addition to PMD, there are other nonlinear effects. Because nonlinear effects tend to manifest themselves when optical power is very high, they become important in DWDM.

Linear effects such as attenuation and dispersion can be compensated, but nonlinear effects *accumulate*. They are the fundamental limiting mechanisms to the amount of data that can be transmitted in optical fiber. The most important types of nonlinear effects are stimulated Brillouin scattering, stimulated Raman scattering, self-phase modulation, and four-wave mixing. In DWDM, four-wave mixing is the most critical of these types.

Four-wave mixing is caused by the nonlinear nature of the refractive index of the optical fiber. Nonlinear interactions among different DWDM channels creates sidebands that can cause interchannel interference. In Figure 2-14 three frequencies interact to produce a fourth frequency, resulting in cross-talk and signal-to-noise degradation.

Figure 2-14 Four-Wave Mixing

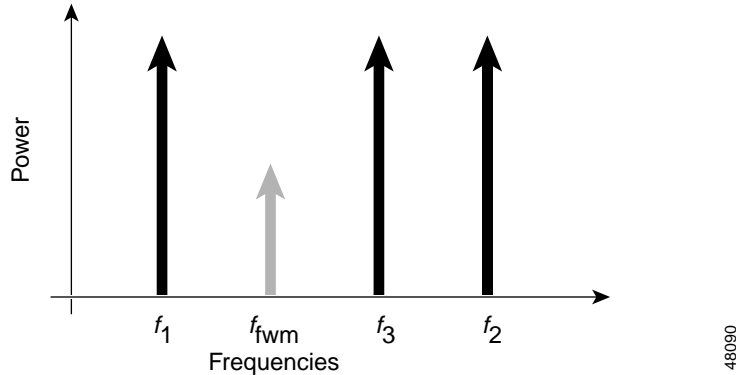

The effect of four-wave mixing is to limit the channel capacity of a DWDM system. Four-wave mixing cannot be filtered out, either optically or electrically, and increases with the length of the fiber. Due to its propensity for four-wave-mixing, DSF is unsuitable for WDM applications. This prompted the invention of NZ-DSF, which takes advantage of the fact that a small amount of chromatic dispersion can be used to mitigate four-wave mixing.

Summary

In the long-distance network, the majority of embedded fiber is standard single-mode (G.652) with high dispersion in the 1550-nm window, which limits the distance for OC-192 transmission. Dispersion can be mitigated to some extent, and at some cost, using dispersion compensators. Non-zero dispersion-shifted fiber can be deployed for OC-192 transport, but higher optical power introduces nonlinear effects.

In the short-haul network, PMD and nonlinear effects are not so critical as they are in long-haul systems, where higher speeds (OC-192 and higher) are more common. DWDM systems using optical signals of 2.5 Gbps or less are not subject to these nonlinear effects at short distances.

The major types of single-mode fibers and their application can be summarized as follows:

- Non-dispersion-shifted fiber (standard SM fiber)—accounts for greater than 95 percent of deployed plant; suitable for TDM (single-channel) use in the 1310-nm region or DWDM use in the 1550-nm region (with dispersion compensators). This type of fiber can also support 10 Gigabit Ethernet standard at distances over 300 meters.
- Dispersion-shifted fiber—suitable for TDM use in the 1550-nm region, but unsuitable for DWDM in this region.
- Non-zero dispersion-shifted fiber—good for both TDM and DWDM use in the 1550-nm region.
- Newer generation fibers—includes types that allow the energy to travel further into the cladding, creating a small amount of dispersion to counter four-wave mixing, and dispersion-flattened fibers, which permit use of wavelengths farther from the optimum wavelength without pulse spreading.



Note

As bit rates increase to 40 Gbps and beyond, the interdependence between system design and fiber design will become increasingly important for strategic planning.

Light Sources and Detectors

Light emitters and light detectors are active devices at opposite ends of an optical transmission system. Light sources, or light emitters, are transmit-side devices that convert electrical signals to light pulses. The process of this conversion, or modulation, can be accomplished by externally modulating a continuous wave of light or by using a device that can generate modulated light directly. Light detectors perform the opposite function of light emitters. They are receive-side opto-electronic devices that convert light pulses into electrical signals.

Light Emitters—LEDs and Lasers

The light source used in the design of a system is an important consideration because it can be one of the most costly elements. Its characteristics are often a strong limiting factor in the final performance of the optical link. Light emitting devices used in optical transmission must be compact, monochromatic, stable, and long-lasting.



Note

Monochromatic is a relative term; in practice there are only light sources within a certain range. Stability of a light source is a measure of how constant its intensity and wavelength are.

Two general types of light emitting devices are used in optical transmission, light-emitting diodes (LEDs) and laser diodes, or semiconductor lasers. LEDs are relatively slow devices, suitable for use at speeds of less than 1 Gbps, they exhibit a relatively wide spectrum width, and they transmit light in a relatively wide cone. These inexpensive devices are often used in multimode fiber communications. Semiconductor lasers, on the other hand, have performance characteristics better suited to single-mode fiber applications.

Figure 2-15 shows the general principles of launching laser light into fiber. The laser diode chip emits light in one direction to be focused by the lens onto the fiber and in the other direction onto a photodiode. The photodiode, which is angled to reduce back reflections into the laser cavity, provides a way of monitoring the output of the lasers and providing feedback so that adjustments can be made.

Figure 2-15 Typical Laser Design

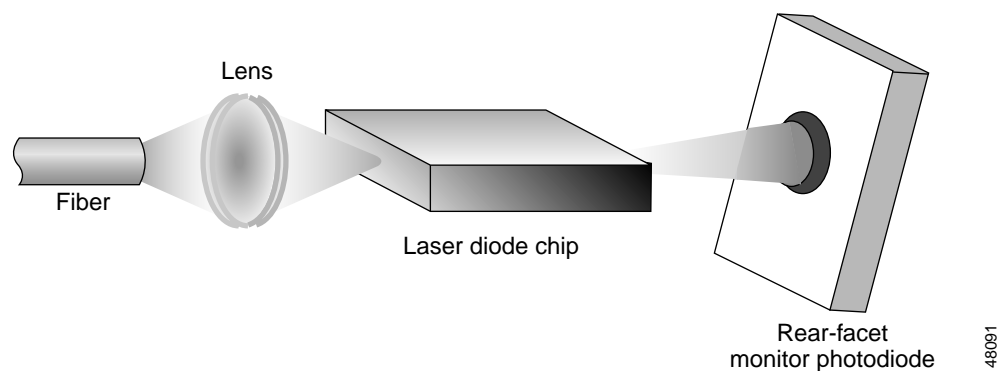

Requirements for lasers include precise wavelength, narrow spectrum width, sufficient power, and control of *chirp* (the change in frequency of a signal over time). Semiconductor lasers satisfy nicely the first three requirements. Chirp, however, can be affected by the means used to modulate the signal.

In directly modulated lasers, the modulation of the light to represent the digital data is done internally. With external modulation, the modulation is done by an external device. When semiconductor lasers are directly modulated, chirp can become a limiting factor at high bit rates (above 10 Gbps). External modulation, on the other hand, helps to limit chirp. The external modulation scheme is depicted in Figure 2-16.

Figure 2-16 External Modulation of a Laser

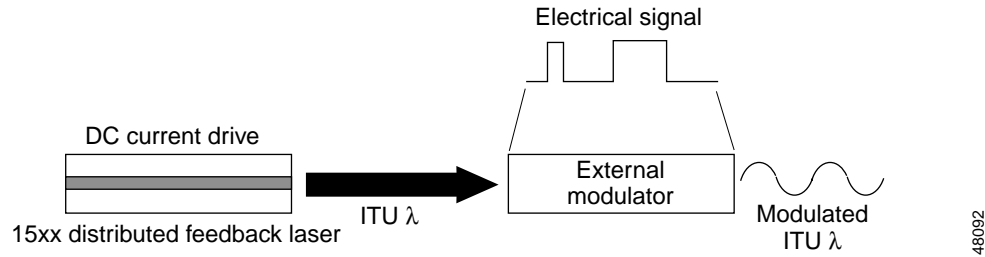

Two types of semiconductor lasers are widely used, monolithic Fabry-Perot lasers, and distributed feedback (DFB) lasers. The latter type is particularly well suited for DWDM applications, as it emits a nearly monochromatic light, is capable of high speeds, has a favorable signal-to-noise ratio, and has superior linearity. DFB lasers also have center frequencies in the region around 1310 nm, and from 1520 to 1565 nm. The latter wavelength range is compatible with EDFAs. There are many other types and subtypes of lasers. Narrow spectrum tunable lasers are available, but their tuning range is limited to approximately 100-200 GHz. Under development are wider spectrum tunable lasers, which will be important in dynamically switched optical networks.

ITU Grid

Cooled DFB lasers are available in precisely selected wavelengths. The ITU draft standard G.692 defines a laser grid for point-to-point WDM systems based on 100-GHz wavelength spacings with a center wavelength of 1553.52 nm (see Table 2-1).

Table 2-1 ITU Grid

Frequency (THz ¹)	Wavelength (nm ²)	Frequency (THz)	Wavelength (nm)	Frequency (THz)	Wavelength (nm)
196.1	1528.77	164.6	1540.56	193.1	1552.52
196.0	1529.55	194.5	1541.35	193.0	1553.33
195.9	1530.33	194.4	1542.14	192.9	1554.13
195.8	1531.12	194.3	1542.94	195.8	1554.94
195.7	1531.9	194.2	1543.73	192.7	1555.75
195.6	1532.68	194.1	1544.53	192.6	1556.56
195.5	1533.47	194.0	1545.32	195.5	1557.36
195.4	1534.25	193.9	1546.12	192.4	1558.17
195.3	1535.04	193.8	1546.92	192.3	1558.98
195.2	1535.82	193.7	1547.72	192.2	1559.79
195.1	1536.61	193.6	1548.51	192.1	1560.61

Table 2-1 ITU Grid (continued)

Frequency (THz ¹)	Wavelength (nm ²)	Frequency (THz)	Wavelength (nm)	Frequency (THz)	Wavelength (nm)
195.0	1537.40	193.5	1549.32	192.0	1561.42
194.9	1538.19	192.4	1550.12	191.9	1562.23
194.8	1538.98	193.3	1550.92	191.8	1563.05
194.7	1539.77	193.2	1551.72	191.7	1563.86

1. THz = terahertz
2. nm = nanometer

While this grid defines a standard, users are free to use the wavelengths in arbitrary ways and to choose from any part of the spectrum. In addition, manufacturers can deviate from the grid by extending the upper and lower bounds or by spacing the wavelengths more closely, typically at 50 GHz, to double the number of channels. The closer the spacing, the more channel crosstalk results. In addition, the impact of some fiber nonlinearities, such as FWM, increases. Spacing at 50 GHz also limits the maximum data rate per wavelength to 10 Gbps. The implications of the flexibility in implementation are twofold: There is no guarantee of compatibility between two end systems from different vendors, and there exists a design trade-off in the spacing of wavelengths between number of channels and maximum bit rate.

Light Detectors

On the receive end, it is necessary to recover the signals transmitted at different wavelengths on the fiber. Because photodetectors are by nature wideband devices, the optical signals are demultiplexed before reaching the detector.

Two types of photodetectors are widely deployed, the positive-intrinsic-negative (PIN) photodiode and the avalanche photodiode (APD). PIN photodiodes work on principles similar to, but in the reverse of, LEDs. That is, light is absorbed rather than emitted, and photons are converted to electrons in a 1:1 relationship. APDs are similar devices to PIN photodiodes, but provide gain through an amplification process: One photon acting on the device releases many electrons. PIN photodiodes have many advantages, including low cost and reliability, but APDs have higher receive sensitivity and accuracy. However, APDs are more expensive than PIN photodiodes, they can have very high current requirements, and they are temperature sensitive.

Optical Amplifiers

Due to attenuation, there are limits to how long a fiber segment can propagate a signal with integrity before it has to be regenerated. Before the arrival of optical amplifiers (OAs), there had to be a repeater for every signal transmitted, as discussed earlier and shown in [Figure 1-11](#). The OA has made it possible to amplify all the wavelengths at once and without optical-electrical-optical (OEO) conversion. Besides being used on optical links, optical amplifiers also can be used to boost signal power after multiplexing or before demultiplexing, both of which can introduce loss into the system.

Erbium-Doped Fiber Amplifier

By making it possible to carry the large loads that DWDM is capable of transmitting over long distances, the EDFA was a key enabling technology. At the same time, it has been a driving force in the development of other network elements and technologies.

Erbium is a rare-earth element that, when excited, emits light around 1.54 micrometers—the low-loss wavelength for optical fibers used in DWDM. Figure 2-17 shows a simplified diagram of an EDFA. A weak signal enters the erbium-doped fiber, into which light at 980 nm or 1480 nm is injected using a pump laser. This injected light stimulates the erbium atoms to release their stored energy as additional 1550-nm light. As this process continues down the fiber, the signal grows stronger. The spontaneous emissions in the EDFA also add noise to the signal; this determines the noise figure of an EDFA.

Figure 2-17 Erbium-Doped Fiber Amplifier Design

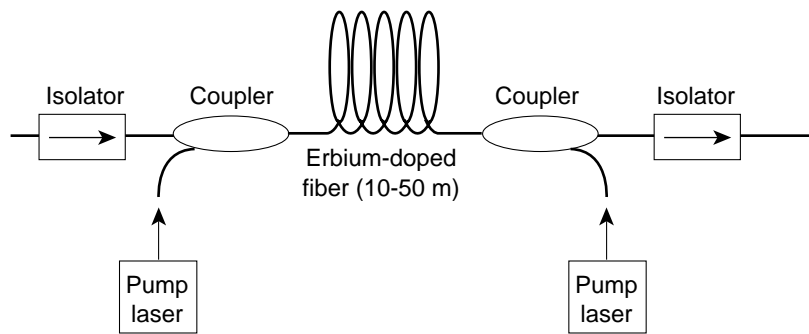

The key performance parameters of optical amplifiers are gain, gain flatness, noise level, and output power. EDFAs are typically capable of gains of 30 dB or more and output power of +17 dB or more. The target parameters when selecting an EDFA, however, are low noise and flat gain. Gain should be flat because all signals must be amplified uniformly. While the signal gain provided with EDFA technology is inherently wavelength-dependent, it can be corrected with gain flattening filters. Such filters are often built into modern EDFAs.

Low noise is a requirement because noise, along with signal, is amplified. Because this effect is cumulative, and cannot be filtered out, the signal-to-noise ratio is an ultimate limiting factor in the number of amplifiers that can be concatenated and, therefore, the length of a single fiber link. In practice, signals can travel for up to 120 km (74 mi) between amplifiers. At longer distances of 600 to 1000 km (372 to 620 mi) the signal must be regenerated. That is because the optical amplifier merely amplifies the signals and does not perform the 3R functions (reshape, retime, retransmit). EDFAs are available for the C-band and the L-band.

Multiplexers and Demultiplexers

Because DWDM systems send signals from several sources over a single fiber, they must include some means to combine the incoming signals. This is done with a multiplexer, which takes optical wavelengths from multiple fibers and converges them into one beam. At the receiving end the system must be able to separate out the components of the light so that they can be discreetly detected. Demultiplexers perform this function by separating the received beam into its wavelength components and coupling them to individual fibers. Demultiplexing must be done before the light is detected, because photodetectors are inherently broadband devices that cannot selectively detect a single wavelength.

In a unidirectional system (see [Figure 2-18](#)), there is a multiplexer at the sending end and a demultiplexer at the receiving end. Two system would be required at each end for bidirectional communication, and two separate fibers would be needed.

Figure 2-18 Multiplexing and Demultiplexing in a Unidirectional System

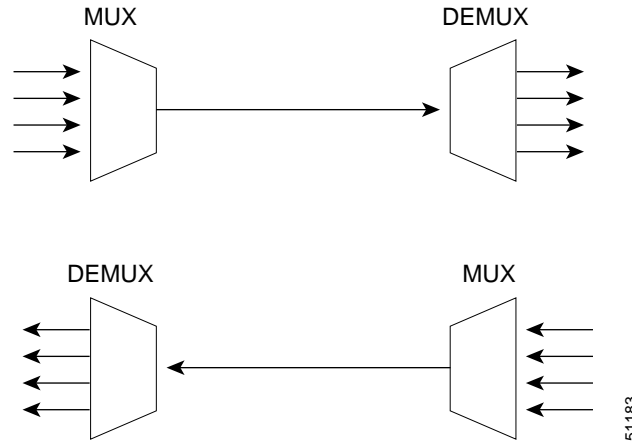

In a bidirectional system, there is a multiplexer/demultiplexer at each end (see [Figure 2-19](#)) and communication is over a single fiber pair.

Figure 2-19 Multiplexing and Demultiplexing in a Bidirectional System

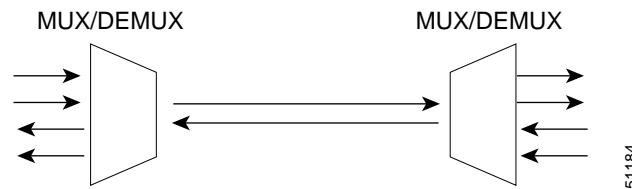

Multiplexers and demultiplexers can be either passive or active in design. Passive designs are based on prisms, diffraction gratings, or filters, while active designs combine passive devices with tunable filters. The primary challenges in these devices is to minimize cross-talk and maximize channel separation. Cross-talk is a measure of how well the channels are separated, while channel separation refers to the ability to distinguish each wavelength.

Techniques for Multiplexing and Demultiplexing

A simple form of multiplexing or demultiplexing of light can be done using a prism. [Figure 2-20](#) demonstrates the demultiplexing case. A parallel beam of polychromatic light impinges on a prism surface; each component wavelength is refracted differently. This is the “rainbow” effect. In the output light, each wavelength is separated from the next by an angle. A lens then focuses each wavelength to the point where it needs to enter a fiber. The same components can be used in reverse to multiplex different wavelengths onto one fiber.

Figure 2-20 Prism Refraction Demultiplexing

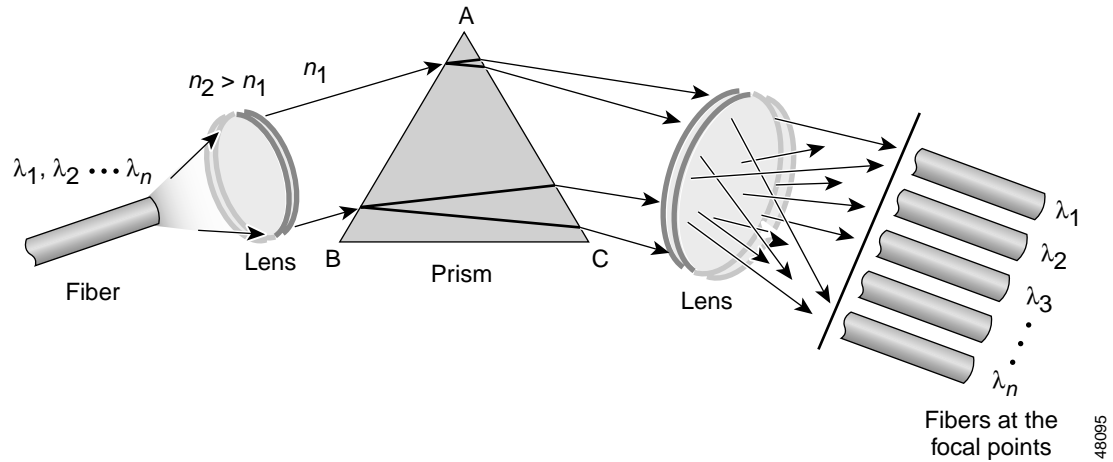

Another technology is based on the principles of diffraction and of optical interference. When a polychromatic light source impinges on a diffraction grating (see Figure 2-21), each wavelength is diffracted at a different angle and therefore to a different point in space. Using a lens, these wavelengths can be focused onto individual fibers.

Figure 2-21 Waveguide Grating Diffraction

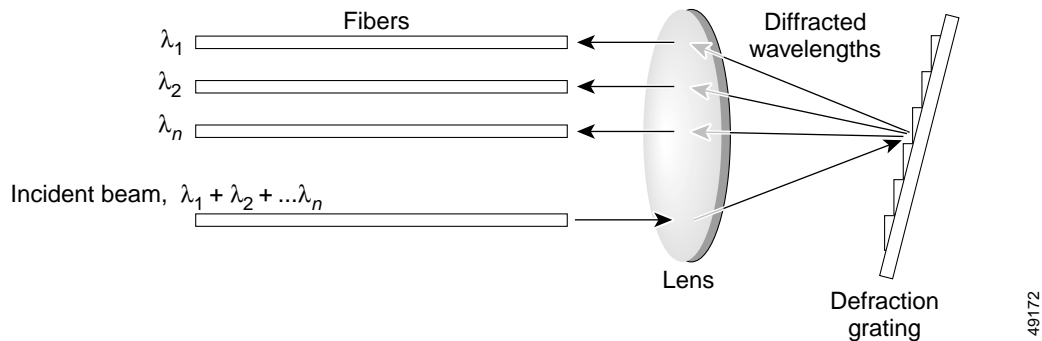

Arrayed waveguide gratings (AWGs) are also based on diffraction principles. An AWG device, sometimes called an optical waveguide router or waveguide grating router, consists of an array of curved-channel waveguides with a fixed difference in the path length between adjacent channels (see Figure 2-22). The waveguides are connected to cavities at the input and output. When the light enters the input cavity, it is diffracted and enters the waveguide array. There the optical length difference of each waveguide introduces phase delays in the output cavity, where an array of fibers is coupled. The process results in different wavelengths having maximal interference at different locations, which correspond to the output ports.

Figure 2-22 Arrayed Waveguide Grating

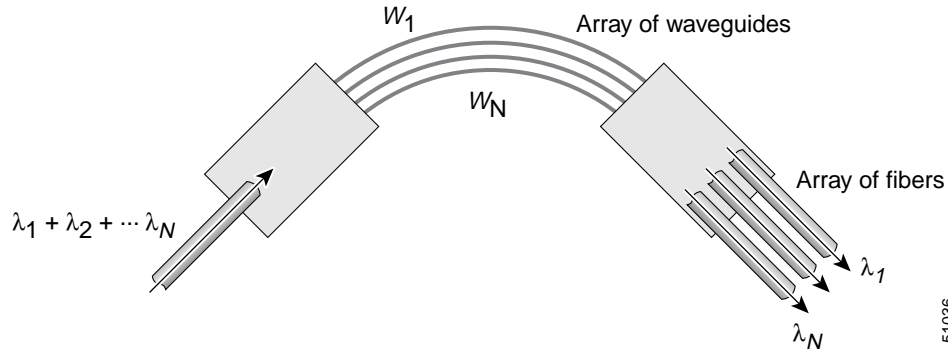

A different technology uses interference filters in devices called *thin film filters* or *multilayer interference filters*. By positioning filters, consisting of thin films, in the optical path, wavelengths can be sorted out (demultiplexed). The property of each filter is such that it transmits one wavelength while reflecting others. By cascading these devices, many wavelengths can be demultiplexed (see Figure 2-23).

Figure 2-23 Multilayer Interference Filters

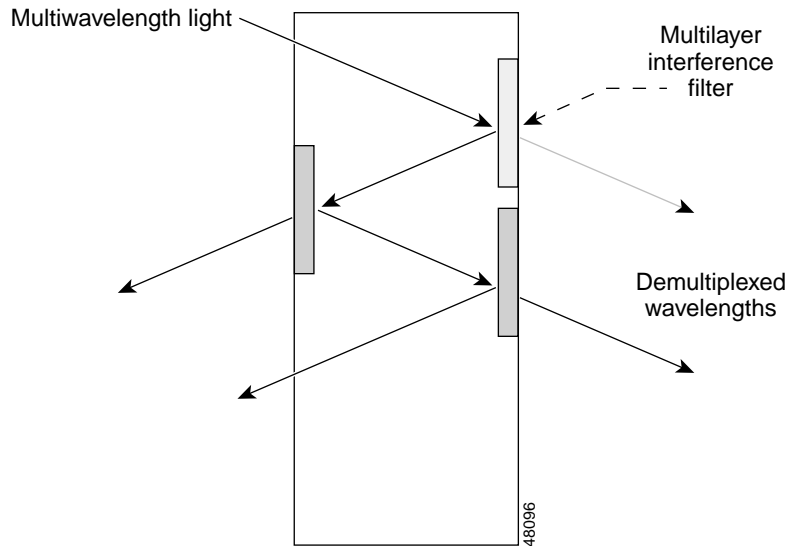

Of these designs, the AWG and thin film interference filters are gaining prominence. Filters offer good stability and isolation between channels at moderate cost, but with a high insertion loss. AWGs are polarization-dependent (which can be compensated), and they exhibit a flat spectral response and low insertion loss. A potential drawback is that they are temperature sensitive such that they may not be practical in all environments. Their big advantage is that they can be designed to perform multiplexing and demultiplexing operations simultaneously. AWGs are also better for large channel counts, where the use of cascaded thin film filters is impractical.

Optical Add/Drop Multiplexers

Between multiplexing and demultiplexing points in a DWDM system, as shown in Figure 2-18, there is an area in which multiple wavelengths exist. It is often desirable to be able to remove or insert one or more wavelengths at some point along this span. An optical add/drop multiplexer (OADM) performs this function. Rather than combining or separating all wavelengths, the OADM can remove some while passing others on. OADMs are a key part of moving toward the goal of all-optical networks.

OADMs are similar in many respects to SONET ADM, except that only optical wavelengths are added and dropped, and no conversion of the signal from optical to electrical takes place. Figure 2-24 is a schematic representation of the add-drop process. This example includes both pre- and post-amplification; these components that may or may not be present in an OADM, depending upon its design.

Figure 2-24 Selectively Removing and Adding Wavelengths

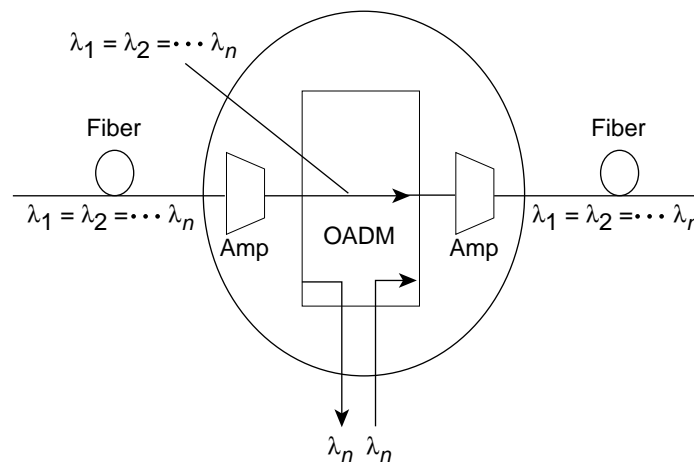

48097

There are two general types of OADMs. The first generation is a fixed device that is physically configured to drop specific predetermined wavelengths while adding others. The second generation is reconfigurable and capable of dynamically selecting which wavelengths are added and dropped.

Thin-film filters have emerged as the technology of choice for OADMs in current metropolitan DWDM systems because of their low cost and stability. For the emerging second generation of OADMs, other technologies, such as tunable fiber gratings and circulators, will come into prominence.

Interfaces to DWDM

Most DWDM systems support standard SONET/SDH short-reach optical interfaces to which any SONET/SDH compliant client device can attach. In today's long-haul WDM systems, this is most often an OC-48c/STM-16c interface operating at the 1310-nm wavelength. In addition, other interfaces important in metropolitan area and access networks are commonly supported: Ethernet (including Fast Ethernet and Gigabit Ethernet), ESCON, Sysplex Timer and Sysplex Coupling Facility Links, and Fibre Channel. The new 10 Gigabit Ethernet standard is supported using a very short reach (VSR) OC-192 interface over MM fiber between 10 Gigabit Ethernet and DWDM equipment.

On the client side there can be SONET/SDH terminals or ADMs, ATM switches, or routers. By converting incoming optical signals into the precise ITU-standard wavelengths to be multiplexed, *transponders* are currently a key determinant of the openness of DWDM systems.

Within the DWDM system a transponder converts the client optical signal from back to an electrical signal and performs the 3R functions (see [Figure 2-25](#)). This electrical signal is then used to drive the WDM laser. Each transponder within the system converts its client's signal to a slightly different wavelength. The wavelengths from all of the transponders in the system are then optically multiplexed. In the receive direction of the DWDM system, the reverse process takes place. Individual wavelengths are filtered from the multiplexed fiber and fed to individual transponders, which convert the signal to electrical and drive a standard interface to the client.

Figure 2-25 Transponder Functions



Future designs include passive interfaces, which accept the ITU-compliant light directly from an attached switch or router with an optical interface.

Operation of a Transponder Based DWDM System

[Figure 2-26](#) shows the end-to-end operation of a unidirectional DWDM system.

Figure 2-26 Anatomy of a DWDM System

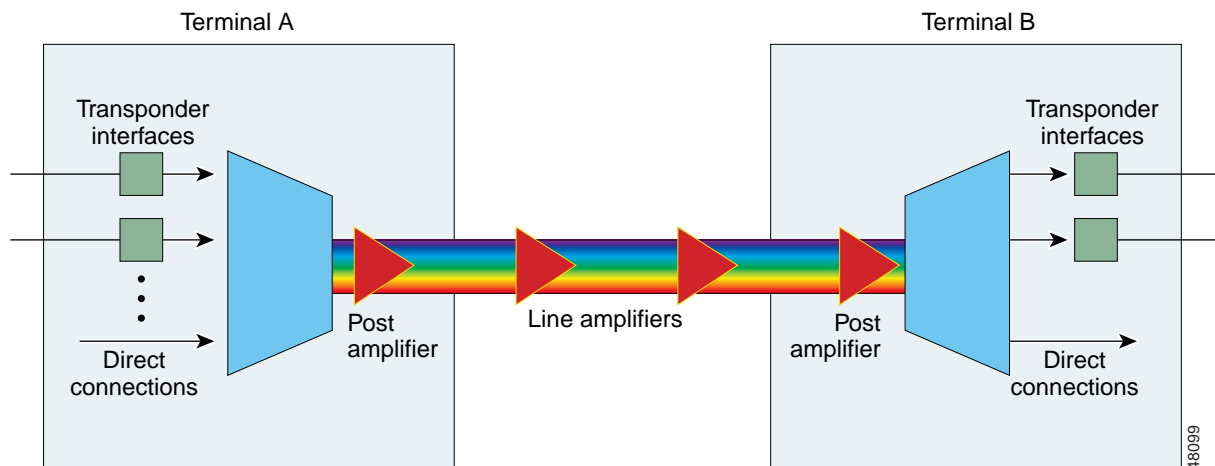

The following steps describe the system shown in [Figure 2-26](#):

1. The transponder accepts input in the form of standard single-mode or multimode laser. The input can come from different physical media and different protocols and traffic types.
2. The wavelength of each input signal is mapped to a DWDM wavelength.
3. DWDM wavelengths from the transponder are multiplexed into a single optical signal and launched into the fiber. The system might also include the ability to accept direct optical signals to the multiplexer; such signals could come, for example, from a satellite node.
4. A post-amplifier boosts the strength of the optical signal as it leaves the system (optional).
5. Optical amplifiers are used along the fiber span as needed (optional).
6. A pre-amplifier boosts the signal before it enters the end system (optional).

7. The incoming signal is demultiplexed into individual DWDM lambdas (or wavelengths).
8. The individual DWDM lambdas are mapped to the required output type (for example, OC-48 single-mode fiber) and sent out through the transponder.