



China Integrated SS7, V5.1, System Supplement

May 2000

Corporate Headquarters

Cisco Systems, Inc.
170 West Tasman Drive
San Jose, CA 95134-1706
USA

<http://www.cisco.com>

Tel: 408 526-4000
800 553-NETS (6387)

Fax: 408 526-4100

THE SPECIFICATIONS AND INFORMATION REGARDING THE PRODUCTS IN THIS MANUAL ARE SUBJECT TO CHANGE WITHOUT NOTICE. ALL STATEMENTS, INFORMATION, AND RECOMMENDATIONS IN THIS MANUAL ARE BELIEVED TO BE ACCURATE BUT ARE PRESENTED WITHOUT WARRANTY OF ANY KIND, EXPRESS OR IMPLIED. USERS MUST TAKE FULL RESPONSIBILITY FOR THEIR APPLICATION OF ANY PRODUCTS.

THE SOFTWARE LICENSE AND LIMITED WARRANTY FOR THE ACCOMPANYING PRODUCT ARE SET FORTH IN THE INFORMATION PACKET THAT SHIPPED WITH THE PRODUCT AND ARE INCORPORATED HEREIN BY THIS REFERENCE. IF YOU ARE UNABLE TO LOCATE THE SOFTWARE LICENSE OR LIMITED WARRANTY, CONTACT YOUR CISCO REPRESENTATIVE FOR A COPY.

The following information is for FCC compliance of Class A devices: This equipment has been tested and found to comply with the limits for a Class A digital device, pursuant to part 15 of the FCC rules. These limits are designed to provide reasonable protection against harmful interference when the equipment is operated in a commercial environment. This equipment generates, uses, and can radiate radio-frequency energy and, if not installed and used in accordance with the instruction manual, may cause harmful interference to radio communications. Operation of this equipment in a residential area is likely to cause harmful interference, in which case users will be required to correct the interference at their own expense.

The following information is for FCC compliance of Class B devices: The equipment described in this manual generates and may radiate radio-frequency energy. If it is not installed in accordance with Cisco's installation instructions, it may cause interference with radio and television reception. This equipment has been tested and found to comply with the limits for a Class B digital device in accordance with the specifications in part 15 of the FCC rules. These specifications are designed to provide reasonable protection against such interference in a residential installation. However, there is no guarantee that interference will not occur in a particular installation.

Modifying the equipment without Cisco's written authorization may result in the equipment no longer complying with FCC requirements for Class A or Class B digital devices. In that event, your right to use the equipment may be limited by FCC regulations, and you may be required to correct any interference to radio or television communications at your own expense.

You can determine whether your equipment is causing interference by turning it off. If the interference stops, it was probably caused by the Cisco equipment or one of its peripheral devices. If the equipment causes interference to radio or television reception, try to correct the interference by using one or more of the following measures:

- Turn the television or radio antenna until the interference stops.
- Move the equipment to one side or the other of the television or radio.
- Move the equipment farther away from the television or radio.
- Plug the equipment into an outlet that is on a different circuit from the television or radio. (That is, make certain the equipment and the television or radio are on circuits controlled by different circuit breakers or fuses.)

Modifications to this product not authorized by Cisco Systems, Inc. could void the FCC approval and negate your authority to operate the product.

The Cisco implementation of TCP header compression is an adaptation of a program developed by the University of California, Berkeley (UCB) as part of UCB's public domain version of the UNIX operating system. All rights reserved. Copyright © 1981, Regents of the University of California.

NOTWITHSTANDING ANY OTHER WARRANTY HEREIN, ALL DOCUMENT FILES AND SOFTWARE OF THESE SUPPLIERS ARE PROVIDED "AS IS" WITH ALL FAULTS. CISCO AND THE ABOVE-NAMED SUPPLIERS DISCLAIM ALL WARRANTIES, EXPRESSED OR IMPLIED, INCLUDING, WITHOUT LIMITATION, THOSE OF MERCHANTABILITY, FITNESS FOR A PARTICULAR PURPOSE AND NONINFRINGEMENT OR ARISING FROM A COURSE OF DEALING, USAGE, OR TRADE PRACTICE.

IN NO EVENT SHALL CISCO OR ITS SUPPLIERS BE LIABLE FOR ANY INDIRECT, SPECIAL, CONSEQUENTIAL, OR INCIDENTAL DAMAGES, INCLUDING, WITHOUT LIMITATION, LOST PROFITS OR LOSS OR DAMAGE TO DATA ARISING OUT OF THE USE OR INABILITY TO USE THIS MANUAL, EVEN IF CISCO OR ITS SUPPLIERS HAVE BEEN ADVISED OF THE POSSIBILITY OF SUCH DAMAGES.

Access Registrar, AccessPath, Any to Any, AtmDirector, Browse with Me, CCDA, CCDE, CCDP, CCIE, CCNA, CCNP, CCSI, CD-PAC, the Cisco logo, Cisco Certified Internetwork Expert logo, *CiscoLink*, the Cisco Management Connection logo, the Cisco NetWorks logo, the Cisco Powered Network logo, Cisco Systems Capital, the Cisco Systems Capital logo, Cisco Systems Networking Academy, the Cisco Systems Networking Academy logo, the Cisco Technologies logo, ConnectWay, Fast Step, FireRunner, Follow Me Browsing, FormShare, GigaStack, IGX, Intelligence in the Optical Core, Internet Quotient, IP/VC, Kernel Proxy, MGX, Natural Network Viewer, NetSonar, Network Registrar, the Networkers logo, *Packet*, PIX, Point and Click Internetworking, Policy Builder, Precept, RateMUX, ScriptShare, Secure Script, ServiceWay, Shop with Me, SlideCast, SMARTnet, SVX, *The Cell*, TrafficDirector, TransPath, ViewRunner, Virtual Loop Carrier System, Virtual Voice Line, VlanDirector, Voice LAN, Wavelength Router, Workgroup Director, and Workgroup Stack are trademarks; Changing the Way We Work, Live, Play, and Learn, Empowering the Internet Generation, The Internet Economy, and The New Internet Economy are service marks; and Aironet, ASIST, BPX, Catalyst, Cisco, Cisco IOS, the Cisco IOS logo, Cisco Systems, the Cisco Systems logo, the Cisco Systems Cisco Press logo, Enterprise/Solver, EtherChannel, EtherSwitch, FastHub, FastLink, FastPAD, FastSwitch, GeoTel, IOS, IP/TV, IPX, LightStream, LightSwitch, MICA, NetRanger, Post-Routing, Pre-Routing, Registrar, StrataView Plus, Stratm, TeleRouter, and VCO are registered trademarks of Cisco Systems, Inc. or its affiliates in the U.S. and certain other countries. All other trademarks mentioned in this document are the property of their respective owners. The use of the word partner does not imply a partnership relationship between Cisco and any of its resellers. (0004R)

China Integrated SS7, V5.1, System Supplement

Copyright © <2000>, Cisco Systems, Inc.

All rights reserved.

SECTION 1 – CHINA INTEGRATED SS7 SYSTEM OVERVIEW

1.1 Introduction	1-1
1.2 Integrated SS7 System Hardware	1-3
1.3 Integrated SS7 System Software	1-4
1.3.1 Integrated SS7 Software Components	1-6

SECTION 2 – INSTALLATION

2.1 Introduction	2-1
2.2 Installation Checklist	2-2
2.3 Verifying Hardware Components	2-3
2.3.1 Non-Redundant Systems	2-3
2.3.2 Redundant Systems	2-4
2.4 Installing the SS7 Shelf: VCO/4K Systems	2-6
2.4.1 Specifications	2-6
2.4.2 Installation	2-7
2.5 Installing Cards And Links: Non-redundant or Side A	2-14
2.6 Installing Peripherals: Non-redundant Systems	2-22
2.7 Installing Cards And Links: Side B Of Redundant Systems	2-26
2.8 Installing Peripherals: Redundant Systems	2-30
2.9 Installing SS7 Selector Switch: Redundant Systems	2-33
2.9.1 Specifications	2-34
2.9.2 Installation	2-34

SECTION 3 – SOFTWARE INSTALLATION AND NETWORK CONFIGURATION

3.1 Introduction	3-1
3.1.1 Network Information Worksheets	3-1
3.1.2 Special Considerations For On-Line Help	3-4
3.2 Installation Checklist	3-5
3.3 Running sys-config	3-7
3.4 Modifying The Integrated SS7 /etc/hosts File	3-25
3.4.1 Modifying The /etc/hosts File For Non-Redundant Configurations	3-27
3.4.2 Modifying The /etc/hosts File For Redundant Configurations	3-27
3.5 Testing The Installation	3-28
3.5.1 Testing Non-Redundant Configurations	3-28
3.5.2 Testing Redundant Configurations	3-29

SECTION 4 – INTEGRATED SS7 CONFIGURATION

4.1	Introduction	4-1
4.2	Configuration Worksheets	4-1
4.3	SS7 Layers Configuration	4-5
4.3.1	MML HELP Command	4-6
4.3.2	Site Configuration Example	4-6
4.3.2.1	MTP Level 2 Provisioning Part	4-8
4.3.2.2	MTP Level 3 Provisioning	4-12
4.3.2.3	TUP Level Provisioning Configuration File	4-14
4.3.3	Creating/Modifying and Loading the Configuration Files for TUP	4-17
4.4	Platform Configuration And Resource Provisioning	4-20
4.4.1	Cktint Configuration File: CktInt.cfg	4-20
4.4.1.1	Rotary/Cyclic Port Selection	4-25
4.4.2	Resource Provisioning Files: tup_ckt_ss7_to_sds & tup_grp_ss7_to_sds	4-26
4.4.2.1	tup_ckt_ss7_to_sds	4-27
4.4.2.2	tup_grp_ss7_to_sds	4-29
4.5	Redundancy Configuration	4-31
4.6	2k to 4k and 4k to 2k Configurator	4-34
4.6.1	2k to 4k Configurator Software	4-34
4.6.2	4k to 2k Configurator Software	4-34
4.6.3	Installation	4-34
4.6.4	Checksums and Sizes	4-35
	2k to 4k Configurator Software	4-35
	4k to 2k Configurator Software	4-35

SECTION 5 – SYSTEM ADMINISTRATION

5.1	Introduction	5-1
5.2	Starting The SS7 Stack And Circuit Interworking	5-1
5.3	CONFIGURING CktInt AND SS7 STACK FOR AUTOSTART	5-3
5.4	MONITORING THE SS7 LINK STATUS	5-4
5.4.1	Display Link Status	5-4
5.4.2	Daily Log Files	5-4
5.4.3	Enabling and Disabling SS7 Message Logging	5-5
5.5	Managing Circuits And Circuit Groups (isup_console)	5-5
5.5.1	Examples	5-7
5.6	Initiating A Switchover	5-9
5.7	Bringing Down The Integrated SS7 System	5-11
5.7.1	Powering Down the SPARC	5-12
5.8	Remote Access	5-12
5.9	Using Scripts/Alias	5-13

SECTION 6 – TUP

6.1 INTRODUCTION	6-1
6.2 Templates	6-3
6.3 CHINA TUP STATE MACHINES	6-5
6.3.1 Basic State Machine	6-6
6.3.2 Outgoing Call Control States	6-7
6.3.3 Incoming Call Control States	6-8
6.4 SS7 Commands and Reports Overview	6-9
6.5 CIRCUIT INTERWORKING COMMANDS AND REPORTS (Standard)	6-12
6.5.1 SS7 Circuit Query (\$30 01) Command (Standard)	6-12
6.5.2 SS7 Circuit Sync (\$30 02) Command (Standard)	6-14
6.5.3 SS7 Network Message Generation (\$49) Command (Standard)	6-16
6.5.4 SS7 Host Call Load Control (\$C0 04) Command (Standard)	6-28
6.5.5 SS7 Host Assume/Relinquish Port Control (\$C0 05) Command (Standard)	6-31
6.5.6 SS7 Circuit Status (\$B0 01) Report (Standard)	6-33
6.5.7 SS7 System Port Status (\$D3) Report (Standard)	6-36
6.5.8 SS7 Circuit Group Status (\$D9) Report (Standard)	6-38
6.5.9 SS7 Network Message Reception (\$EA) Report (Standard)	6-40
6.5.10 SS7 Alarm Condition (\$F0) Report (Standard)	6-48
6.6 CIRCUIT INTERWORKING COMMANDS AND REPORTS (Extended)	6-50
6.6.1 SS7 Circuit Query (\$30 01) Command (Extended)	6-50
6.6.2 SS7 Circuit Sync (\$30 02) Command (Extended)	6-52
6.6.3 SS7 Network Message Generation (\$49) Command (Extended)	6-54
6.6.4 SS7 Host Call Load Control (\$C0 04) Command (Extended)	6-68
6.6.5 SS7 Host Assume/Relinquish Port Control (\$C0 05) Command (Extended)	6-71
6.6.6 SS7 Circuit Status (\$B0 01) Report (Extended)	6-73
6.6.7 SS7 System Port Status (\$D3) Report (Extended)	6-76
6.6.8 SS7 Circuit Group State (\$D9) Report (Extended)	6-78
6.6.9 SS7 Network Message Reception (\$EA) Report (Extended)	6-80
6.6.10 SS7 Alarm Condition (\$F0) Report (Extended)	6-88
6.7 CALL FLOW EXAMPLES	6-90
6.7.1 Outbound COT Call Flow Examples	6-93

APPENDIX A – UNIX/VI EDITOR BASICS

APPENDIX B – FILE STRUCTURE

APPENDIX C – UPGRADING/RE-INSTALLING THE OPERATING PLATFORM

APPENDIX D – UPGRADING/RE-INSTALLING THE INTEGRATED SS7 SOFTWARE

APPENDIX E – TUP MESSAGE TYPES AND PARAMETERS

Figure 1.1: Sample Integrated SS7 System Configuration	1-2
Figure 1.2: Integrated SS7 System from a Software Point of View	1-4
Figure 1.3: Software Configuration Example with Eight Hosts	1-5
Figure 1.4: Integrated SS7 System Software Components	1-6
Figure 2.1: SS7 Shelf Back View (Door Closed)	2-7
Figure 2.2: Connecting P2 Ribbon Cable	2-8
Figure 2.3: Connecting P2 Ribbon Cable	2-9
Figure 2.4: Right-side NEBS Bracket	2-10
Figure 2.5: SS7 Shelf Front View (Door Closed)	2-11
Figure 2.6: Ground Stud Stackup	2-12
Figure 2.7: VME SS7 Shelf A&B Power Inputs	2-13
Figure 2.8: SPARC CPU5V Switch Locations	2-14
Figure 2.9: SPARC CPU5V Switch Settings	2-15
Figure 2.10: Installation of SPARC CPU/Sbus Assembly and Storage Subsystem: VME SS7 Shelf	2-16
Figure 2.11: Cutaway Side View	2-17
Figure 2.12: Ethernet Pathway	2-18
Figure 2.13: SS7 Shelf Rear Distribution Panel	2-19
Figure 2.14: SS7 Network Link Connections (4-link)	2-20
Figure 2.15: SS7 Network Link Connections (8-link)	2-21
Figure 2.16: Serial A+B Port Location	2-22
Figure 2.17: ASCII Terminal Connections	2-23
Figure 2.18: Modem Drive Connections	2-24
Figure 2.19: CD-ROM Drive Connections	2-25
Figure 2.20: Assembly and Storage Subsystem Installation: Side B VME SS7 Shelf	2-27
Figure 2.21: Front View of Redundant SS7 System	2-29
Figure 2.22: Modem Connections on Redundant Systems	2-32
Figure 2.23: SS7 Selector Switch (4-link)	2-33
Figure 2.24: Ground Stud Stackup	2-35
Figure 2.25: SS7 Selector Switch DC Power Inlet	2-36
Figure 2.26: SS7 Selector Switch Status/Control Connections	2-37
Figure 2.27: SS7 Selector Switch to Signaling Links	2-38
Figure 2.28: SS7 Selector Switch A/B Toggle Switch Position	2-39
Figure 3.1: Terminal Type Screen	3-7
Figure 3.2: Host Name Screen	3-8

Figure 3.3: Network Connectivity Screen	3-9
Figure 3.4: IP Address Screen	3-10
Figure 3.5: Confirm Host, Network, And IP Address Screen	3-11
Figure 3.6: Name Service Screen	3-12
Figure 3.7: Domain Name Screen	3-13
Figure 3.8: Name Server Screen	3-14
Figure 3.9: Specify Name Server Information Screen	3-15
Figure 3.10: Confirm Information Screen	3-15
Figure 3.11: Sample Name Service Error Screen	3-16
Figure 3.12: Subnet Screen	3-17
Figure 3.13: Confirm Information Screen	3-18
Figure 3.14: Netmask Screen	3-19
Figure 3.15: Default Region Screen	3-20
Figure 3.16: Default Time Zone Screen	3-21
Figure 3.17: Default Date and Time Screen	3-22
Figure 3.18: Confirm Time Zone and Date and Time Screen	3-23
Figure 3.19: Specify Root Password Screen	3-24
Figure 3.20: /etc/hosts Files in a Redundant Configuration	3-26
Figure 4.1: Site Configuration Example	4-7
Figure 4.2: MTP Level 2 Provisioning Example	4-8
Figure 4.3: MTP Level 3 Provisioning Example	4-12
Figure 4.4: TUP Level Provisioning Example	4-14
Figure 4.5: Sample CktInt.cfg File	4-20
Figure 4.6: Resource Group Configuration File Example	4-25
Figure 4.7: Sample tup_ckt_ss7_to_sds Configuration File	4-27
Figure 4.8: Sample Line From tup_grp_ss7_to_sds File	4-29
Figure 5.1: Sample Link Status Display	5-4
Figure 5.2: Sample Status Display	5-7
Figure 5.3: SS7 Selector Switch A/B Toggle Switch In AUTO Position	5-10
Figure 5.4: AAC A/B Toggle Switch In AUTO Position	5-10
Figure 6.1: Circuit Interworking	6-2
Figure 6.2: Basic State Machine	6-6
Figure 6.3: Substates for Outgoing Busy State	6-7
Figure 6.4: Incoming Call Control States	6-8
Figure 6.5: Handling of Commands by the Integrated SS7 System	6-9

Figure 6.6: Handling of Reports by the Integrated SS7 System	6-10
Figure 6.7: Typical Calling Line Identity Parameter Format (per protocol spec)	6-21
Figure 6.8: SS7 \$49 Command Calling Line Identity Parameter Format	6-21
Figure 6.9: Sample Calling Line Identity Parameter Per Protocol Coding	6-22
Figure 6.10: Sample Calling Line Identity Parameter Coding for SS7 \$49 Command	6-22
Figure 6.11: Typical Original Called Address Parameter Format (per protocol spec)	6-23
Figure 6.12: SS7 \$49 Command Original Called Address Parameter Format	6-23
Figure 6.13: Sample Called Address Parameter Per Protocol Coding	6-23
Figure 6.14: Sample Called Address Parameter Coding for SS7 \$49 Command	6-24
Figure 6.15: Typical Incoming Trunk and Transit Exchange ID Parameter Format (per protocol spec)	6-24
Figure 6.16: SS7 \$49 Command Incoming Trunk and Transit Exchange ID Parameter Format	6-24
Figure 6.17: Sample Incoming Trunk and Transit Exchange ID Parameter Per Protocol Coding	6-25
Figure 6.18: Sample Incoming Trunk and Transit Exchange ID Parameter Coding for SS7 \$49 Command	6-25
Figure 6.19: Typical Calling Line Identity Parameter Format (per protocol spec)	6-42
Figure 6.20: SS7 \$EA Report Calling Line Identity Parameter Format	6-43
Figure 6.21: Sample Calling Line Identity Parameter Per Protocol Coding	6-43
Figure 6.22: Sample Calling Line Identity Parameter Coding for SS7 \$EA Report	6-44
Figure 6.23: Typical Original Called Address Parameter Format (per protocol spec)	6-44
Figure 6.24: SS7 \$EA Report Original Called Address Parameter Format	6-44
Figure 6.25: Sample Called Address Parameter Per Protocol Coding	6-45
Figure 6.26: Sample Called Address Parameter Coding for SS7 \$EA Report	6-45
Figure 6.27: Typical Incoming Trunk and Transit Exchange ID Parameter Format (per protocol spec)	6-46
Figure 6.28: SS7 \$EA Report Incoming Trunk and Transit Exchange ID Parameter Format	6-46
Figure 6.29: Sample Incoming Trunk and Transit Exchange ID Parameter Per Protocol Coding	6-47
Figure 6.30: Sample Incoming Trunk and Transit Exchange ID Parameter Coding for SS7 \$EA Report	6-47
Figure 6.31: Typical Calling Line Identity Parameter Format (per protocol spec)	6-60
Figure 6.32: SS7 \$49 Command Calling Line Identity Parameter Format	6-60
Figure 6.33: Sample Calling Line Identity Parameter Per Protocol Coding	6-61
Figure 6.34: Sample Calling Line Identity Parameter Coding for SS7 \$49 Command	6-61
Figure 6.35: Typical Original Called Address Parameter Format (per protocol spec)	6-62

Figure 6.36: SS7 \$49 Command Original Called Address Parameter Format	6-62
Figure 6.37: Sample Called Address Parameter Per Protocol Coding	6-63
Figure 6.38: Sample Called Address Parameter Coding for SS7 \$49 Command	6-63
Figure 6.39: Typical Incoming Trunk and Transit Exchange ID Parameter Format (per protocol spec)	6-64
Figure 6.40: SS7 \$49 Command Incoming Trunk and Transit Exchange ID Parameter Format 6-64	
Figure 6.41: Sample Incoming Trunk and Transit Exchange ID Parameter Per Protocol Coding	6-65
Figure 6.42: Sample Incoming Trunk and Transit Exchange ID Parameter Coding for SS7 \$49 Command	6-65
Figure 6.43: Typical Calling Line Identity Parameter Format (per protocol spec)	6-82
Figure 6.44: SS7 \$EA Report Calling Line Identity Parameter Format	6-83
Figure 6.45: Sample Calling Line Identity Parameter Per Protocol Coding	6-83
Figure 6.46: Sample Calling Line Identity Parameter Coding for SS7 \$EA Report	6-84
Figure 6.47: Typical Original Called Address Parameter Format (per protocol spec)	6-84
Figure 6.48: SS7 \$EA Report Original Called Address Parameter Format	6-84
Figure 6.49: Sample Called Address Parameter Per Protocol Coding	6-85
Figure 6.50: Sample Called Address Parameter Coding for SS7 \$EA Report	6-85
Figure 6.51: Typical Incoming Trunk and Transit Exchange ID Parameter Format (per protocol spec)	6-86
Figure 6.52: SS7 \$EA Report Incoming Trunk and Transit Exchange ID Parameter Format 6-86	
Figure 6.53: Sample Incoming Trunk and Transit Exchange ID Parameter Per Protocol Coding	6-87
Figure 6.54: Sample Incoming Trunk and Transit Exchange ID Parameter Coding for SS7 \$EA Report	6-87
Figure 6.55: Non-SS7-To-SS7 Call Establishment	6-90
Figure 6.56: SS7-to-Non-SS7 Call Establishment	6-91
Figure 6.57: SS7-to-SS7 Call Establishment	6-92
Figure B.1: Cktint Directory Tree	B-1

Table 4.1: CktInt.cfg Parameters	4-21
Table 4.2: Resource Group Configuration File Fields	4-26
Table 4.3: Circuit Configuration Fields	4-29
Table 4.4: Circuit Group Configuration Fields	4-30
Table 6.1: Circuit Interworking Commands.	6-11
Table 6.2: Circuit Interworking Reports	6-11
Table A.1: UNIX Basics	A-1
Table A.2: vi editor Commands	A-3
Table B.1: Cktint Directories	B-1
Table E.1: TUP Message Types Listed By Binary Code	E-1
Table E.2: TUP Message Types Listed By Name	E-3
Table E.3: TUP Message Parameters Listed By Binary Code	E-6
Table E.4: TUP Message Parameters Listed By Name	E-7

Preface

The *China Integrated SS7 System Supplement* provides detailed information about how to use the Integrated SS7 System to integrate Signaling System No 7 (SS7) networks with VCO/4K Systems. This supplement is organized as follows:

- **Section 1**—Contains a product overview
- **Section 2**—Contains instructions for installing the system hardware
- **Section 3**—Describes how to unpack the software with the sys-config script and how to configure the system on the network
- **Section 4**—Describes how to configure the Integrated SS7 system components
- **Section 5**—Describes how to manage the Integrated SS7 system
- **Section 6**—Describes TUP applications
- **Appendix A**—Lists basic UNIX/vi editor basics
- **Appendix B**—Describes the file structure of the Integrated SS7 system software
- **Appendix C**—Contains instructions for upgrading/re-installing the Integrated SS7 operating platform
- **Appendix D**—Contains instructions for upgrading/re-installing the Integrated SS7 system software
- **Appendix E**—Lists the TUP message types and parameters

For information about the enhancements, problems corrected, special considerations, and known functional constraints, refer to the *China Integrated SS7 TUP Release Notes*.

This supplement is intended for programmers familiar with the VCO/4K Systems, SS7 concepts, UNIX, and Ethernet.

Cisco Connection Online

Cisco Connection Online (CCO) is Cisco Systems' primary, real-time support channel. Maintenance customers and partners can self-register on CCO to obtain additional information and services.

Available 24 hours a day, 7 days a week, CCO provides a wealth of standard and value-added services to Cisco's customers and business partners. CCO services include product information, product documentation, software updates, release notes, technical tips, the Bug Navigator, configuration notes, brochures, descriptions of service offerings, and download access to public and authorized files.

CCO serves a variety of users through two interfaces that update and enhance simultaneously: a character-based version and a multimedia version that resides on the World Wide Web (WWW). The character-based CCO supports Zmodem, Kermit, Xmodem, FTP, and Internet e-mail, and it is excellent for quick access to information over lower bandwidths. The WWW version of CCO provides richly formatted documents with photographs, figures, graphics, and video, as well as hyperlinks to related information.

You can access CCO in the following ways:

- WWW: <http://www.cisco.com>
- WWW: <http://www-europe.cisco.com>
- WWW: <http://www-china.cisco.com>
- Telnet: [cco.cisco.com](telnet://cco.cisco.com)
- Modem: From North America, 408 526-8070; from Europe, 33 1 6446 40 82. Use the following terminal settings: VT100 emulation; databits: 8; parity: none; stop bits: 1; and connection rates up to 28.8 kbps.

For a copy of CCO's Frequently Asked Questions (FAQ), contact cco-help@cisco.com. For additional information, contact cco-team@cisco.com.

NOTE: If you need personal technical assistance with a Cisco product that is under warranty or covered by a maintenance contract, contact Cisco's Technical Assistance Center (TAC) at 800 553-2447, 408 526-7209, or tac@cisco.com. To obtain general information about Cisco Systems, Cisco products, or upgrades, contact 800 553-6387, 408 526-7208, or cs-rep@cisco.com.

See the front matter of this document for details about the standard Cisco product warranties.

Section 1 CHINA INTEGRATED SS7 SYSTEM OVERVIEW

1.1 INTRODUCTION

The China Integrated SS7 product serves as a gateway between Signaling System No. 7 (SS7) intelligent networks and Public Switched Telephone Networks (PSTN) by integrating the SS7 network with a VCO/4K system and host computer(s). This integration can significantly improve call processing because the call setup information arrives independent of the voice traffic. Independent signaling increases the call processing rate by a minimum of 60% over the rates of other signaling methods. SS7 integration also reduces network congestion and deployment costs through greater port utilization and alternative routing capabilities.

The China Integrated SS7 product allows the service provider to implement the following enhanced services:

- Telephone User Part (TUP) services for call processing and switching, such as:
 - *Operator Services System support*
 - *ISDN or Feature Group D Interworking*
 - *Personal Communication Services (PCS)/Enhanced Services Billing*
 - *Integration of full Service Switching Point (SSP) functionality on the VCO/4K*
 - *Wireless and wire line interworking*

The Integrated SS7 is a system consisting of both hardware and software components that are installed in a VME SS7 shelf that can be mounted in a 19-inch utility rack with a VCO/4K system. An Integrated SS7 system can support one VCO/4K system and up to eight host computers that all reside on Ethernet LAN.

Figure 1.1 is an illustration of an Integrated SS7 system configured with a VCO/4K and four host computers. The Integrated SS7 system connects directly to the Ethernet LAN and SS7 network.

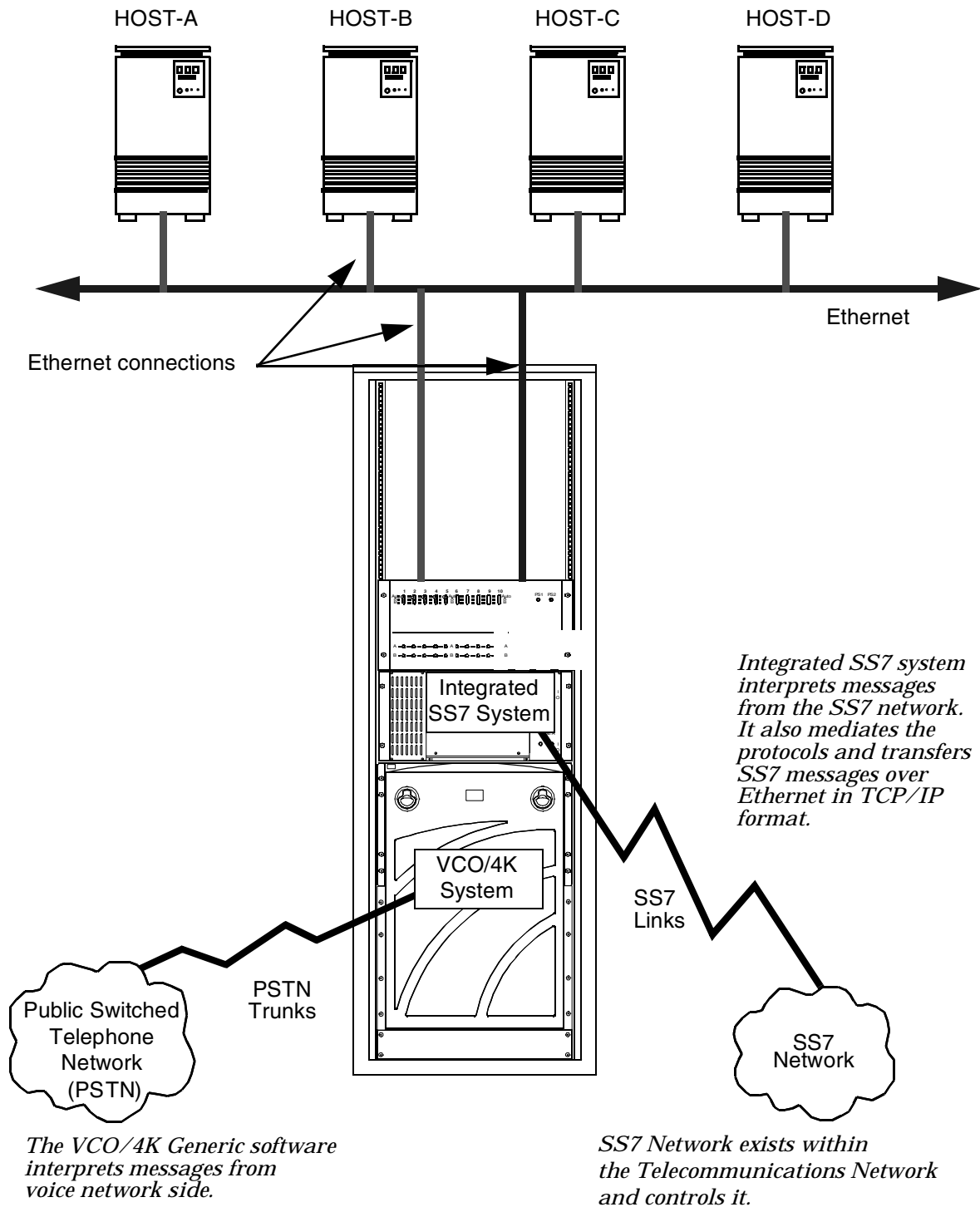

Figure 1.1: Sample Integrated SS7 System Configuration

1.2 INTEGRATED SS7 SYSTEM HARDWARE

A non-redundant Integrated SS7 system consists of the following hardware components:

- One SPARC CPU/Sbus Assembly
- One Storage Subsystem (3.5-inch 1.4MB floppy disk and 1GB, 2GB, or 4GB hard drive with SCSI interfaces)
- One VME SS7 Shelf
- One external CD-ROM drive
- One modem
- One administrative console

NOTE: The modem and administrative console can be customer supplied.

The CPU/Sbus Assembly runs at 110 MHz and is equipped with 32MB or 64MB RAM. Ports on the card's front panel support connections to the Integrated SS7 system peripherals and SS7 network.

The hardware includes an external CD-ROM drive so that the Integrated SS7 system software can be reinstalled if the factory-installed version is damaged or corrupted. The power supply in the CD-ROM drive is a universal power supply with 100–120/200–220 VAC, and 47–63 hertz. The external CD-ROM drive does not need to be connected to the system for normal operation.

For redundant systems, an Integrated SS7 system consists of the following hardware components:

- Two SPARC CPU/Sbus Assemblies
- Two Storage Subsystems (3.5-inch 1.4MB floppy disk and 1GB, 2GB, or 4GB hard drive with SCSI interfaces)
- One VME SS7 Shelf
- One external CD-ROM drive
- One SS7 selector switch for redundancy
- One modem/A/B transfer switch
- Two administrative consoles (or one dual session console)

NOTE: The modem/A/B transfer switch and administrative console can be customer supplied.

Modem support and console operation can also be done using Telnet sessions.

Note that the Integrated SS7 hardware for redundant configurations includes an SS7 selector switch, which provides SS7 link redundancy for both sides of the redundant Integrated SS7 system. The selector switch is a –48 VDC device, designed to mount in a 19-inch utility rack separate from the VCO/4K. When installing in a site with AC power only, an AC to DC converter is required. (The converter is supplied by the customer.)

CAUTION: Do not mount the SS7 selector switch in the VCO/4K or power it with the VCO/4K's power supply.

The hardware for a redundant Integrated SS7 system configuration includes one external CD-ROM drive and one modem. The external CD-ROM drive can be connected to either side of the configuration without affecting the operation of the system. The modem is connected to both sides of the redundant system by an electronic A/B transfer switch (which you must purchase separately).

A single ASCII terminal can also be connected to both sides with a second electronic A/B transfer switch. However, the transfer switch must be capable of providing surgeless, spikeless change-overs. If the transfer switch does not have this capability, the Integrated SS7 system may abort and return to the boot monitor when change overs occur.

1.3 INTEGRATED SS7 SYSTEM SOFTWARE

From a software point of view, the Integrated SS7 system sits between the host computer and the VCO/4K system on the Ethernet as shown in Figure 1.2. To the host application, the Integrated SS7 system is the server. However, to the VCO/4K generic software, the Integrated SS7 is a client. The Integrated SS7 system also provides the interface to the SS7 Network.

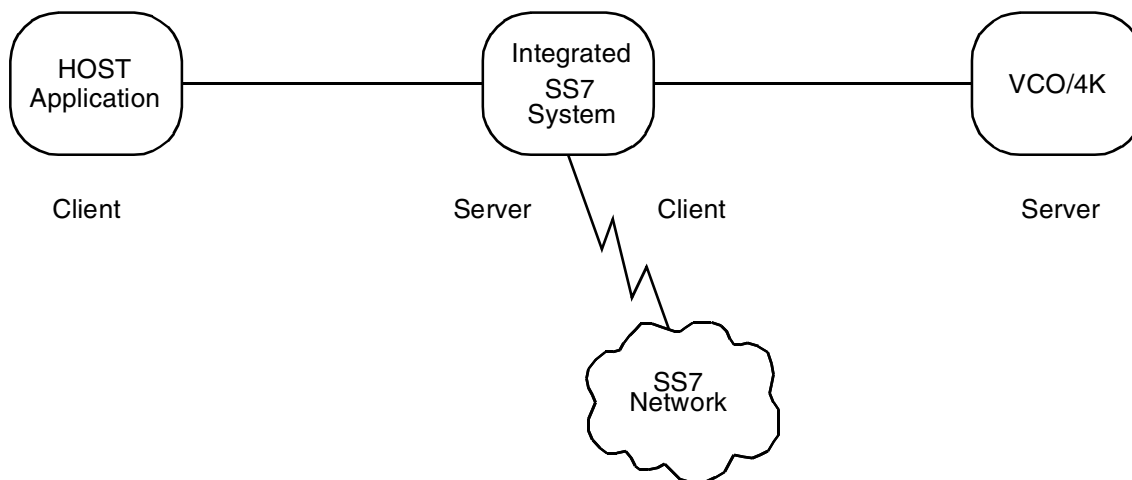

Figure 1.2: Integrated SS7 System from a Software Point of View

The Integrated SS7 software supports up to eight TCP connections as shown in Figure 1.3. These are logical links, not physical links.

CAUTION: Additional TCP connections affect VCO/4K call handling capacity. Optimal performance can be achieved with four or fewer simultaneously active TCP connections.

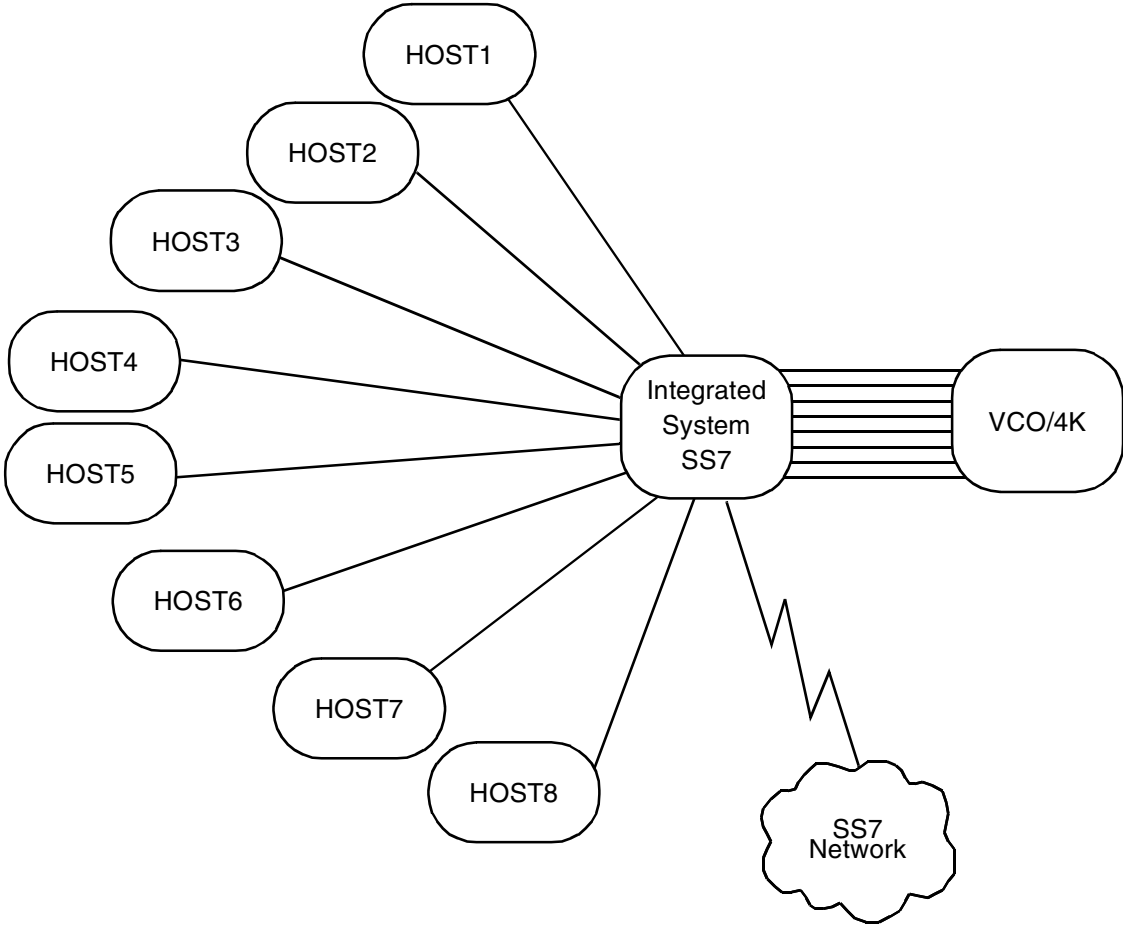

Figure 1.3: Software Configuration Example with Eight Hosts

For each logical link between the host and the Integrated SS7 system, there also is a logical link between the Integrated SS7 system and the VCO/4K. This provides an end-to-end communication path between each host and the VCO/4K.

At initialization, the Integrated SS7 system waits for a connection request from a host. Once a host connection is established, the Integrated SS7 system sends a connection request to the VCO/4K.

The hosts share the incoming SS7 call load in either a ROUNDROBIN or BROADCAST mode. In ROUNDROBIN mode, the next host computer in line becomes the controlling host. In BROADCAST mode, the Integrated SS7 sends a report to all active host computers and a host takes control of the call port depending on the call port addresses specified in the host's application program.

SS7 messages from the host are sent to Integrated SS7 software through commands with a destination VCA of \$C1. SS7 messages from the network are translated into host reports with a source VCA of \$C1.

1.3.1 Integrated SS7 Software Components

The Integrated SS7 software is installed on the Integrated SS7 system's hard drive and consists of the following components:

- Solaris OS
- Software modules that perform the actual interworking processes
- Software modules that interface between the SS7 network, VCO/4K, and the host computer
- Software modules that provide configuration, control, and administration functions

Figure 1.4 is an illustration of the Integrated SS7 system software architecture.

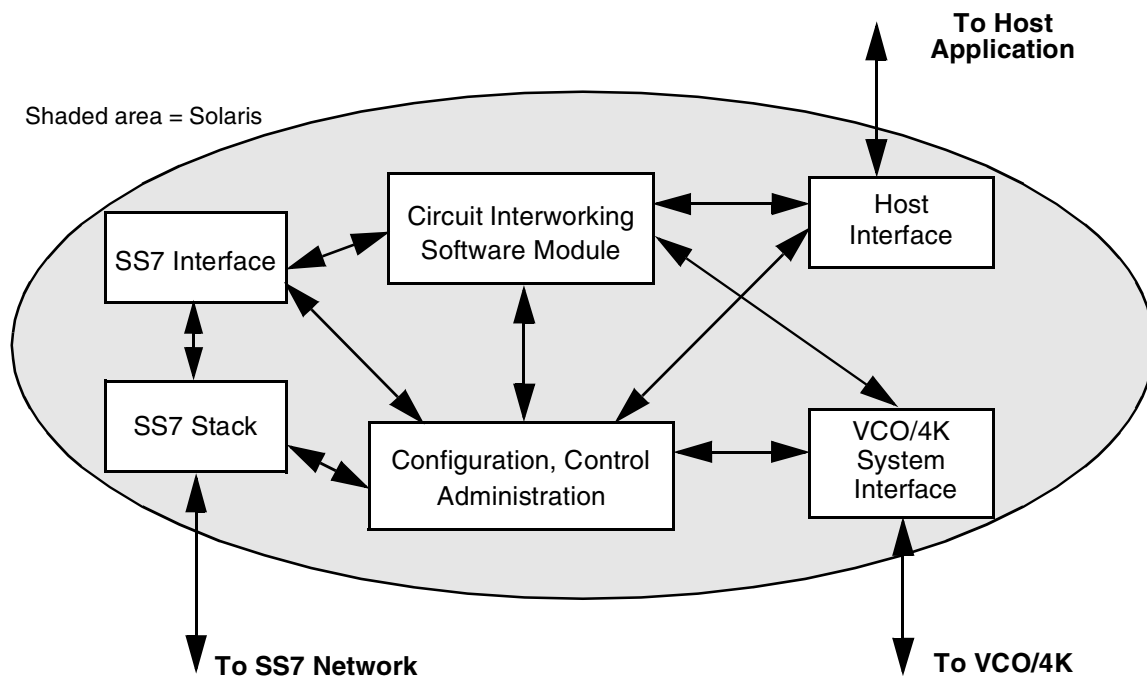

Figure 1.4: Integrated SS7 System Software Components

SS7 Stack

Provides the data link for signaling. The stack consists of three layers that map one for one to the first three layers of the standard SS7 protocol (Message Transfer Part (MTP) Level 1, MTP Level 2, and MTP Level 3). For further information on the function of these stacks, refer to *Section 4.3*.

Circuit Interworking Software Module

Translates SS7 signals for the VCO/4K and host applications and performs call processing and circuit maintenance tasks. SS7 messages are encapsulated and presented to the host system in VCO/4K or SS7 commands and reports.

During call processing, the Circuit Interworking software acts upon the call setup and call clearing messages. The rest of the call processing is the responsibility of the host application. The Circuit Interworking software transmits information to the host, it translates all SS7 messages into SS7 Network Message Reception (SEA) reports. The host application is then responsible for generating SS7 messages using the Integrated SS7 Network Message Generation(\$49) command.

The host application, through the SS7 \$49 Command, is also responsible for generating the SS7 call acceptance message (ACM), SS7 answer message (ANC), and the SS7 call clearing message (CLF).

Circuit Interworking software supports SS7-to-SS7 calls, SS7-to-VCO/4K calls, and VCO/4K-to-SS7 calls.

Interface Software Modules (SS7 Interface—Host Interface—VCO/4K System Interface)

The Integrated SS7 system software includes interface software modules for the SS7 network, VCO/4K, and host computer. All modules communicate over Ethernet using TCP/IP.

When the VCO/4K Interface software module receives a report from the VCO/4K, the report is passed to the Circuit Interworking software. Call control commands are also transmitted to the VCO/4K by the Circuit Interworking software through the VCO/4K's Interface.

The SS7 Network Interface software module manages the interface to SS7 links on the Integrated SS7 system. SS7 messages from the network are transmitted to the Circuit Interworking software through this interface. SS7 messages generated by the Circuit Interworking software to the SS7 network also pass through the SS7 Network Interface software module.

The Host Interface software module manages the interface to the host computer. This interface supports the transmission of both SS7 and VCO/4K-related event reports to the host, as well as receipt of command messages destined for either the SS7 network or the VCO/4K. All received messages are passed to the Circuit Interworking software module, where they are processed by the software module or passed to the SS7 network or VCO/4K.

Configuration, Control, and Administration

The Integrated SS7 System Configuration data contains the information necessary for the Circuit Interworking software module to interface with the VCO/4K, host computer, and SS7 network.

The Integrated SS7 System Resource Provisioning data contains the circuit IDs and the circuit groups.

The Integrated SS7 Call Processing Configuration data dictates the content of SS7 messages that are generated and transmitted to the SS7 network by the Circuit Interworking software.

Section 2 INSTALLATION

2.1 INTRODUCTION

This section describes how to install the Integrated SS7 hardware in a VCO/4K system. This section is organized as follows:

- *Section 2.2* is a list of the tasks that must be completed for an Integrated SS7 hardware installation.
- *Section 2.3* is a list of hardware components. Before you begin the installation, verify that you have received all components. If components are missing, contact Cisco Systems Technical Support.
- *Section 2.4* describes how to install the VME SS7 Shelf. The SS7 Shelf is an external VME enclosure for the Integrated SS7 hardware (SPARC CPU/Sbus Assembly and SS7 Storage Subsystem). It allows VCO/4K customers to implement SS7 applications without reducing the number of slots available for port interface and service circuit cards.
- *Section 2.5* describes how to install the cards in non-redundant systems or Side A of redundant systems. This subsection also describes how to physically connect the links to the SS7 network.
- *Section 2.6* describes how to install the ASCII terminal, modem, and CD-ROM on non-redundant systems. This completes the installation on non-redundant systems. *If you have a redundant system, skip this subsection.*
- *Section 2.7* describes how to install the cards in Side B of a redundant system, and how to connect the Side B links to the SS7 network.
- *Section 2.8* describes how to install the ASCII terminals, modem, and CD-ROM on redundant systems.
- *Section 2.9* describes how to install the SS7 selector switch for redundant systems. The SS7 selector switch provides SS7 link redundancy connection to sides A and B of the Integrated SS7 system.

2.2 INSTALLATION CHECKLIST

This subsection summarizes the tasks that must be completed for an Integrated SS7 hardware installation. Items are listed in the order they should be completed.

NOTE: This list is independent of installing the VCO/4K system. Cisco Systems recommends the VCO/4K system be completely installed prior to an SS7 installation.

Hardware Installation Task List

1. Verify hardware components (see *Section 2.3*).
2. Install hardware into the VME shelf:
 - CPU
 - Hard drive
 - Back plane ribbon
 - Verify jumper settings
 - Mount VME SS7 shelf and fall back switch
 - Power VME SS7 shelf and fall back switch
3. Install cables:
 - Data links
 - Fall back switch
 - Ethernet/LAN
 - Console/status control and Y-cable
 - Modem (if used)
4. Verify configuration information (refer to SS7 Facilities Planning Checklist):
 - IP address(es)*
 - SPARC Hostname(s)*
 - VCO/4K hostname(s*)
 - Host socket(s)*
 - Name service, domain, subnet (check with LAN administrator)
 - SS7 point codes—Cisco, STPs, Tandem switch
 - CICs
 - Route set names
 - Link set names
 - Span locations on VCO/4K
5. Connect console to A-side SPARC and boot A-side SPARC.

** Need two for a redundant system, or one for a non-redundant system.*

2.3 VERIFYING HARDWARE COMPONENTS

Your hardware depends on whether you ordered a non-redundant or redundant system.

2.3.1 Non-Redundant Systems

If you ordered a non-redundant system, you should have received the following components:

- SPARC CPU5V/Sbus assembly
- Storage Subsystem
- One P2 ribbon cable
- One cable with micro D-26 to DB-25 connectors
- One two-way splitter cable with DB-25 to DB-25 connectors
- Either four (4-link) or eight (8-link) SS7 network link cables with micro D-26 to DB-37 connectors
- One three-way splitter cable with DB-37 to three DB-25s
- External CD-ROM drive with SCSI cable

NOTE: The power supply in the CD-ROM drive is a universal power supply with 100–120/200–220 VAC, and 47–63 hertz.

- One VME SS7 Shelf and a NEBS bracket mounting kit

NOTE: The VME shelf has an internal cable harness for connection to ports on the CPU5V to the rear connection panel.

In addition to these components, a non-redundant system requires the following components, which you must purchase separately:

- Ethernet AUI cable or LAN transceiver

*NOTE: You **must** use shielded cables for your Ethernet AUI connections.*

- Modem (for remote maintenance)/one 25-foot EIA/TIA-232 cable with DB-25 to DB-25 connectors

*NOTE: **There is no modem capability with an 8-link system.** Instead, you must arrange dial-up to a local network and Telnet access to the SS7 subsystem.*

- ASCII terminal with cable
- Null modem (essential for installation/configuration)

CAUTION: Attaching a terminal to the SS7 SPARC serial port can cause an SS7 reboot/halt under certain failure conditions. This complication is in the Solaris operating system, which hangs when the VT console is either powered down or has a power supply failure.

Cisco Systems recommends disconnecting the VT terminal(s) from the SPARC processor serial connection and either (a) reconnecting for active use only, or (b) leaving disconnected and performing all terminal functions via a Telnet session from the host or another connectivity device.

- 19-inch utility rack
- -48 VDC power source

NOTE: If your site has AC power only, an AC-to-DC rectifier of sufficient output power must be used.

2.3.2 Redundant Systems

If you ordered a redundant system, you should have received the following components:

- Two SPARC CPU5V/Sbus assemblies
- Two Storage Subsystems
- Two P2 ribbon cables
- Two cables with micro D-26 to DB-25 connectors
- Two two-way splitter cables with DB-25 to DB-25 connectors
- Either eight (4-link) or 16 (8-link) SS7 network link cables with micro D-26 to DB-37 connectors
- Two three-way splitter cables with DB-37 to DB-25 connectors
- External CD-ROM Drive with SCSI cable

NOTE: The power supply in the CD-ROM drive is a universal power supply with 100–120/200–220 VAC, and 47–63 hertz.

- One VME SS7 Shelf and a NEBS bracket mounting kit

NOTE: The VME shelf has an internal cable harness for connection to ports on the CPU5V to the rear connection panel.

- One SS7 Selector Switch
- Eight cables with DB-25 to DB-37 connectors
- Four cables with DB-25 to DB-37 connectors
- One EBS Status/Control cable assembly

In addition to these components, a redundant installation requires the following components, which you must purchase separately:

- Two Ethernet AUI cable or LAN transceivers

*NOTE: You **must** use shielded cables for your Ethernet AUI connections.*

- Modem (for remote maintenance)/two 25-foot EIA/TIA-232 cables with DB-25 to DB-25 connectors

NOTE: Cisco Systems recommends a separate modem to each side. Otherwise, the modem connection can hang periodically and be unusable.

- A/B transfer switch for single modem (available from Cisco Systems)

*NOTE: **There is no modem capability with an 8-link system.** Instead, you must arrange dial-up to a local network and Telnet access to the SS7 subsystem.*

- Two ASCII terminals with cables
- Two null modems (essential for installation/configuration), or one null modem and one ASCII terminal with dual session capability (available from Cisco Systems)

CAUTION: Attaching a terminal to the SS7 SPARC serial port can cause an SS7 reboot/halt under certain failure conditions. This complication is in the Solaris operating system, which hangs when the VT console is either powered down or has a power supply failure.

Cisco Systems recommends disconnecting the VT terminal(s) from the SPARC processor serial connection and either (a) reconnecting for active use only, or (b) leaving disconnected and performing all terminal functions via a Telnet session from the host or another connectivity device.

- 19-inch utility rack for the SS7 Selector Switch and VME SS7 Shelf
- Two -48 VDC power sources for the SS7 Selector Switch and VME SS7 Shelf

NOTE: If your site has AC power only, an AC-to-DC rectifier of sufficient output power must be used.

2.4 INSTALLING THE SS7 SHELF: VCO/4K SYSTEMS

This subsection describes how to install the VME SS7 Shelf.

2.4.1 Specifications

Part Number:	Contact your Cisco Systems sales representative
Dimensions:	Height — 8.75 inches (22.23 cm) Depth — 20 inches (50.8 cm) Width — 19 inches (48.26 cm) Designed to mount in a 19" rack
Power Input:	-48 VDC — dual input
Current:	5.0 amps maximum, 2.5 amps typical per input
Input Fuse Size:	10 amps/250 volts
Compliance:	EMI/EMC FCC Part 15 (U.S. and Canada) EN55022/50082 (for Europe) NEBS GR-63-CORE (Issue 1, 1995) GR-1089-CORE (Issue 2, 1997) UL 1950 CSA C22.2 EN60950 (for Europe) IEC-950
Weight (max.):	40 lbs.
Operational Temperature Range:	40 to 100°F 10 to 40°C
Operational Temperature Gradient:	15°F (10°C) per hour
Operational Humidity:	20 to 80 percent (%), non-condensing
Operational Altitude:	0 to 10,000 ft 0 to 3,048 m

2.4.2 Installation

To install the VME SS7 shelf, complete the following steps:

1. Locate the VME SS7 shelf. Open the rear door by unscrewing the four captive fastener screws (see Figure 2.1).

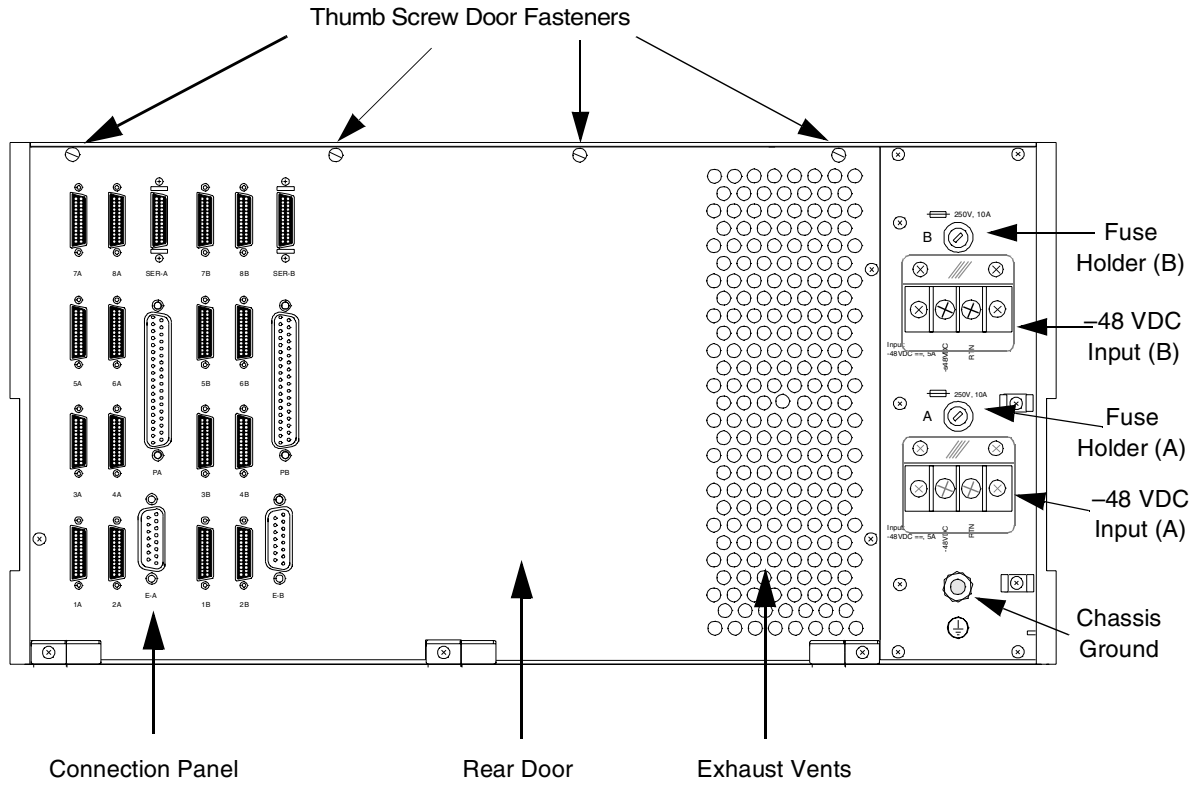

Figure 2.1: SS7 Shelf Back View (Door Closed)

2. Locate the P2 ribbon cable and connect the cable to the bottom, left side DIN connectors, labeled 1 and 3, as shown in Figure 2.2. *The red stripe (pin 1) goes toward the right.*

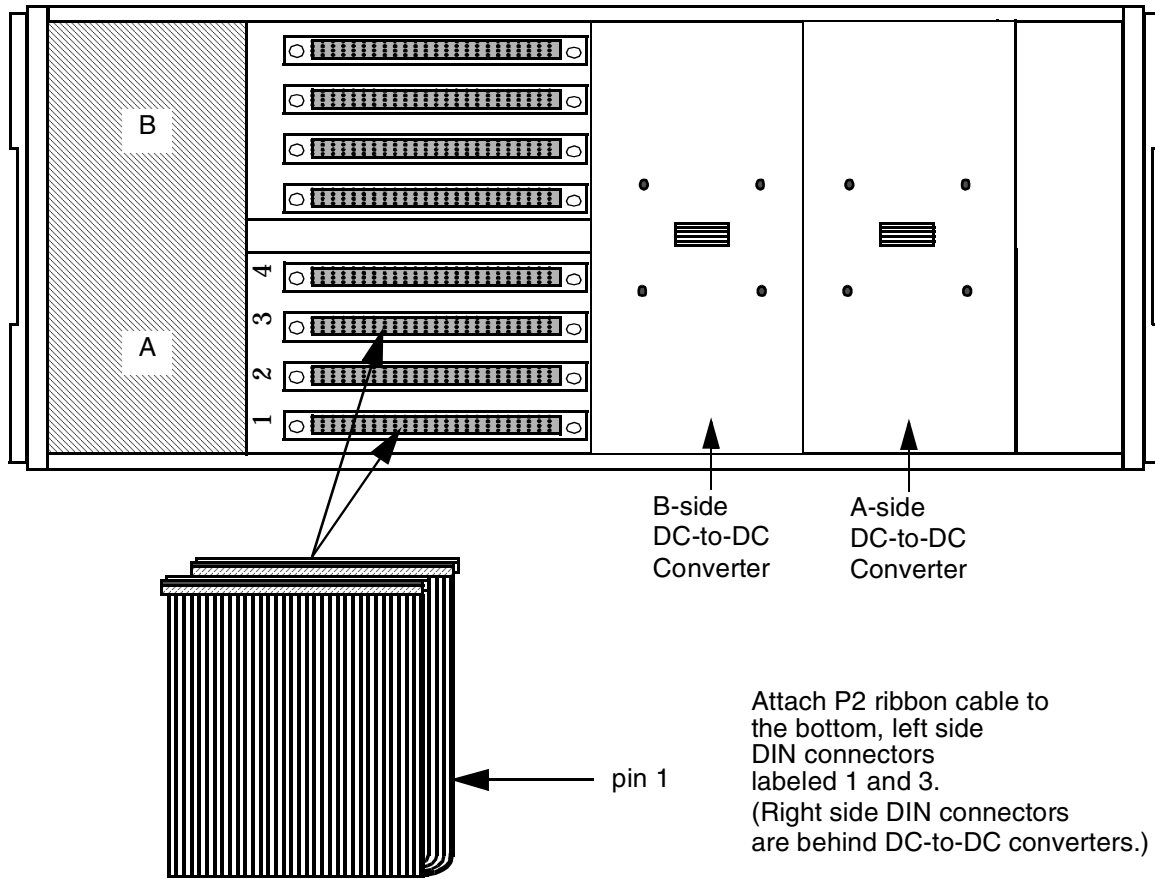

Figure 2.2: Connecting P2 Ribbon Cable

3. If you have a non-redundant configuration, go to Step 5.
If you have a redundant configuration, locate the second P2 ribbon cable and connect the cable to the top, left side DIN connectors, labeled 1 and 3, as shown in Figure 2.3. *The red stripe (pin 1) goes toward the right.*

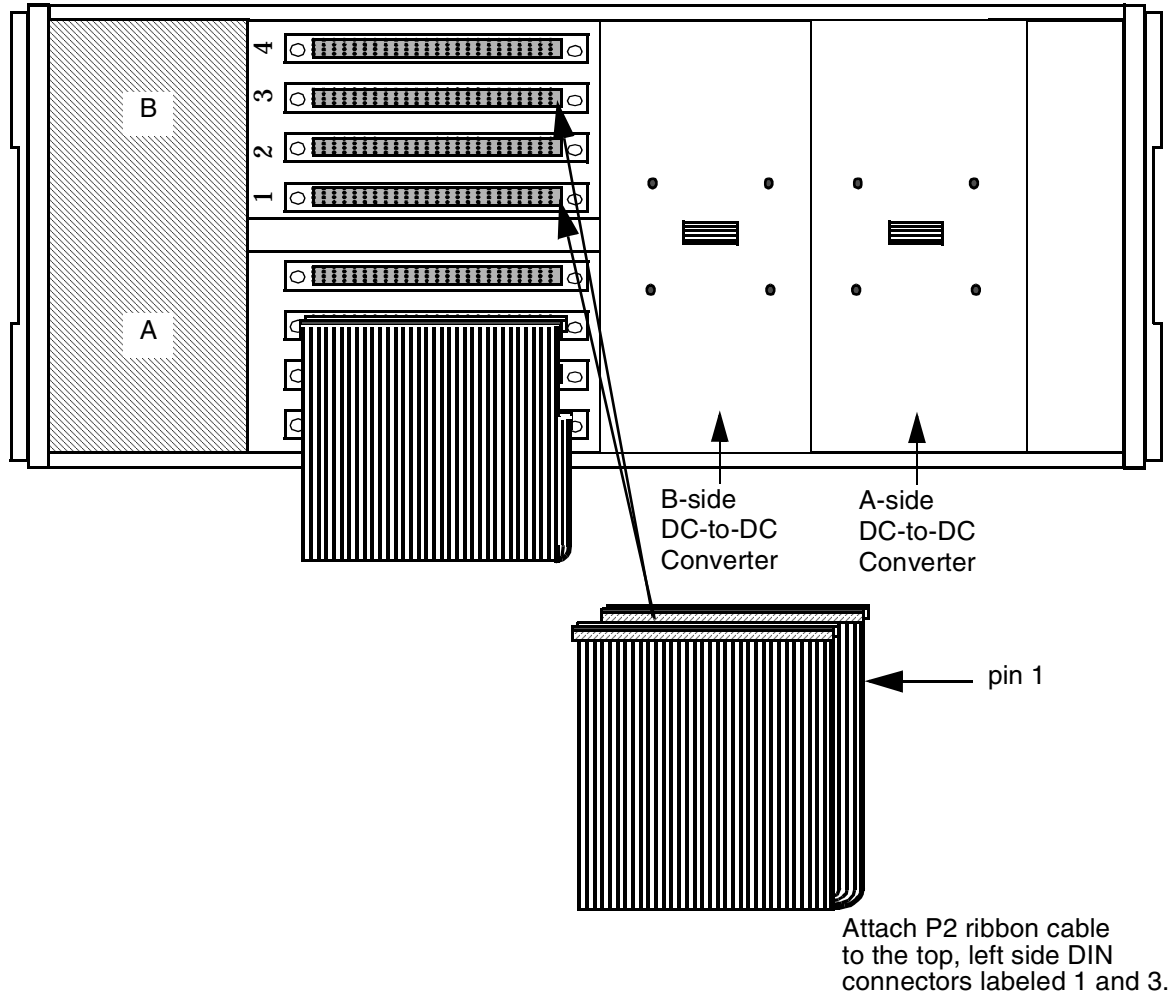

Figure 2.3: Connecting P2 Ribbon Cable

4. Close the rear door and hand tighten the top captive screws.

5. For NEBS-compliant earthquake rack installation, you *must* locate and install the brackets that were shipped with your VME SS7 shelf.

To install these brackets, complete the following:

- a. Identify which bracket goes on which side. The right-side bracket is stamped with the part number 700-06753-01. The left-side bracket is stamped with the part number 700-06845-01.
- b. Locate the four M5 x 10mm SEM screws included in the bracket kit.
- c. Hold each bracket flush against the appropriate side of the SS7 VME shelf and line up the side screw holes; make sure the front bracket bend is parallel with the SS7 chassis rack-mount ears (refer to Figure 2.4).
- d. Use a #2 Phillips-head screwdriver to hand-tighten two screws on the side of each bracket.
- e. Use an adjustable torque wrench equipped with a #2 Phillips bit to tighten each screw to 21 to 29 in.-lb.

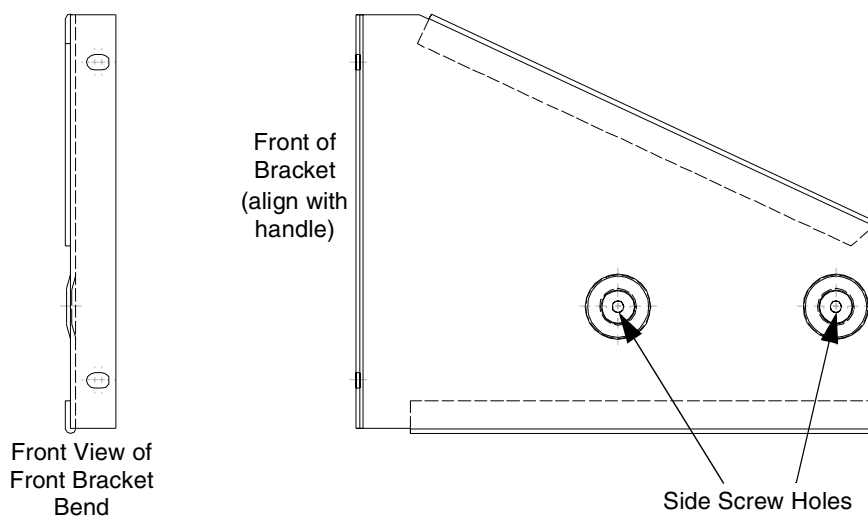

Figure 2.4: Right-side NEBS Bracket

6. Install the VME SS7 Shelf in a 19-inch rack.
 - a. Make sure your screws go through both the shelf handles and the mounting brackets (if you chose to install them).
 - b. Use an adjustable torque wrench to tighten all four appropriate mounting screws in accordance with common workmanship standards.

NOTE: The shelf requires its own -48 VDC power source, which is not supplied by Cisco Systems. The shelf cannot be powered by the VCO/4K.

NOTE: Cisco Systems recommends using at least two people to install the SS7 shelf.

7. Go to the front of the shelf and verify that both power switches are in the off position (down).

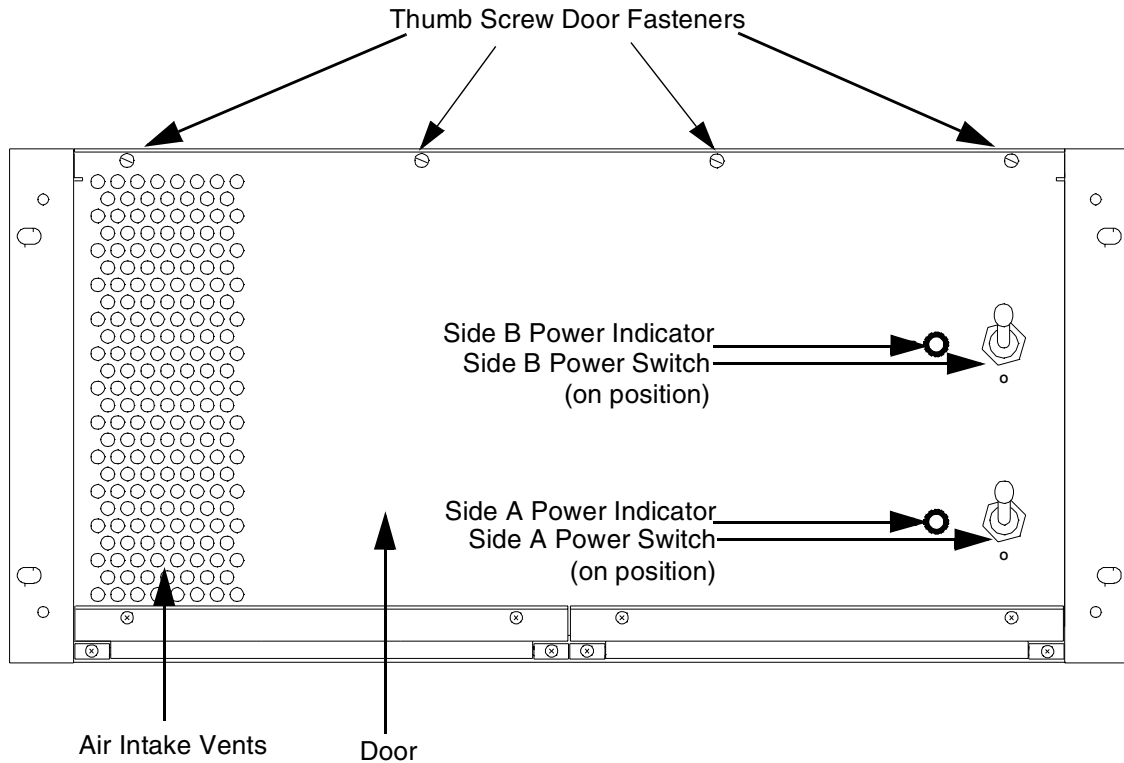

Figure 2.5: SS7 Shelf Front View (Door Closed)

The toggle switches are designed with spring-loaded locking mechanisms so the shelf cannot be accidentally powered on or off. Unlock the toggle switch by gently pulling the switch outward. Flip the switch downward to turn the power off. When the toggle is in the proper position, the spring mechanism locks the switch in place.

8. Attach building ground to the ground point on the rear of the SS7 chassis (see Figure 2.7). Use 14 AWG green/yellow stranded wire and an M5 lug. Attach the M5 lug to the SS7 chassis ground point according to the stackup shown below (Figure 2.6). Use an adjustable torque wrench to tighten the nut to 21 to 29 in.-lb.

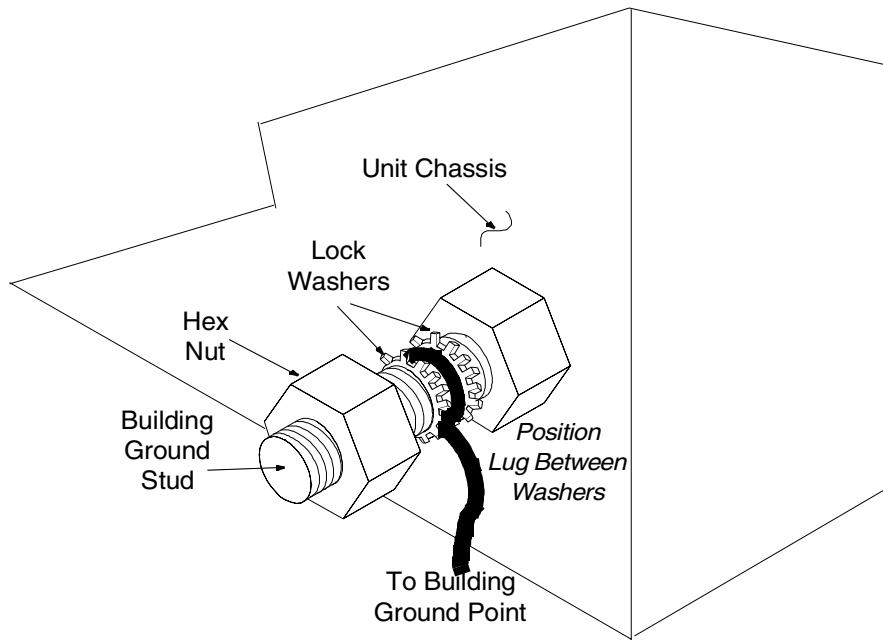

Figure 2.6: Ground Stud Stackup

9. Configure your -48 VDC power source (purchased separately) for the VME SS7 Shelf.

CAUTION: Disconnect the power source supplying the feed circuit(s) that enter your SS7 shelf. Tag the circuits at the disconnect points to warn others not to turn the power on while work is being completed. Leave the power feed disconnected until you have completed power source installation in the shelf and are ready to test it.

The power source connector on the SS7 shelf is a terminal block with an attached 3-pin modular pigtail power connector, as shown in Figure 2.7.

NOTE: All shelves, whether they are used in a non-redundant or redundant configuration, are equipped with two DC-to-DC converters, which are identical and interchangeable.

For redundant systems, the DC-to-DC converter for side A is mounted on the right, and the converter for side B is mounted on the left (when viewed from the rear of the unit). Each converter operates independent of the other; they do not share the load. If you have a problem with a converter on a redundant shelf, that side of the shelf will not operate until you replace the converter.

For non-redundant systems, the converter on side A supplies all of the DC voltages for shelf slots 1 through 4. The converter installed in side B can be used as a spare. In redundant systems, the converter in side B supplies power for shelf slots 5 through 8.

10. Make a power cable for your shelf. Use 14 AWG color-coded stranded wire per the pinouts represented in Figure 2.7. Cisco Systems supplies a male three-pin connector mate for the end of your power cable; white conductors are -48 VDC, A-side or B-side inputs, and black conductors are Battery Return, A-side or B-side inputs.

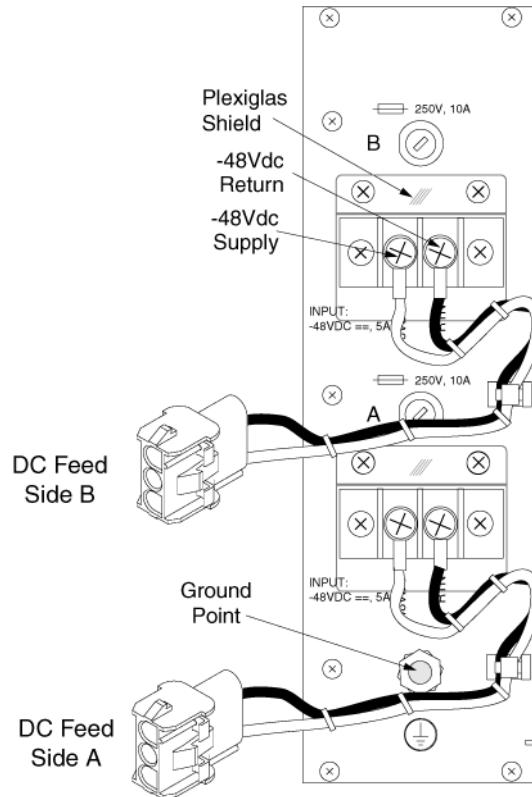

Figure 2.7: VME SS7 Shelf A&B Power Inputs

11. Go to the back of the shelf and connect the power cable(s) to the DC feed connector(s) shown in Figure 2.7 (A for a non-redundant system or A and B for redundant systems).
12. Connect the other end of the power cable(s) to your power source.
13. Reconnect the power source supplying the feed circuit(s) that enter your SS7 shelf.
14. To test the shelf, go to the front of the shelf and flip the power switch(es) on (upward position) and verify that the appropriate green LED illuminates.

If the LED does not illuminate, perform the following checks:

- a. Verify that the -48 VDC power source is on and that there is -48 VDC at the end of the cable to the shelf.
- b. Check the main power fuse (one each on A and B inputs).
- c. **Turn the power off** and remove the DC-to-DC power converter back panel. Verify that the connectors for the DC-to-DC converter are tight.
- d. Check the 15-amp fuse on the converter.
- e. Verify that the green LED on the front of the system is good.

If you cannot locate the problem, contact Cisco Systems Technical Support.

15. After you have tested the shelf, toggle the shelf's power switch(es) off (downward position).

2.5 INSTALLING CARDS AND LINKS: NON-REDUNDANT OR SIDE A

To install the Integrated SS7 system hardware on a non-redundant system or side A of redundant systems, complete the following steps:

CAUTION: Observe antistatic precautions when handling the cards to avoid damaging sensitive CMOS devices. Wear a ground strap connected to the grounded system equipment frame whenever dealing with system components.

1. If you haven't already done so, verify that you have all of the hardware components with your order. If you are missing components, contact Cisco Systems Technical Support.
2. Power off the VCO/4K, according to the instructions in the *VCO/4K System Maintenance Manual*.
3. Remove the SPARC CPU/Sbus assembly from its packaging.

Verify that the DIP switches are set correctly, as shown in Figure 2.9.

CAUTION: If the DIP switch settings are not correct on the SPARC CPU5V, the VCO/4K database gets corrupted. This applies to both redundant and non-redundant systems.

Figure 2.8 shows the location of the switches on a SPARC CPU5V.

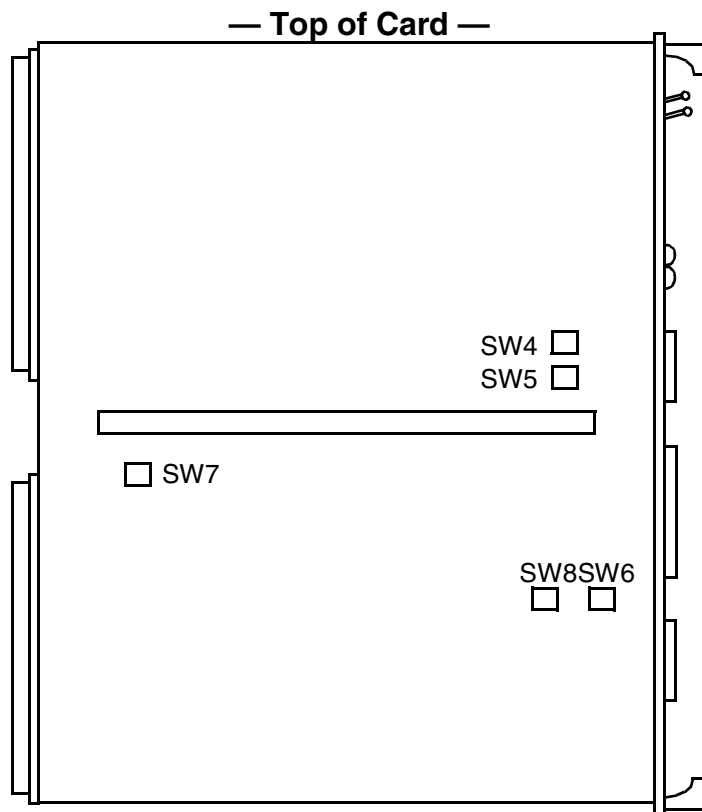
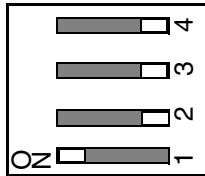

Figure 2.8: SPARC CPU5V Switch Locations

Figure 2.9 shows the correct setting for each switch on a SPARC CPU5V.



SW4

- S4-1 = on
- S4-2 = off
- S4-3 = off
- S4-4 = off

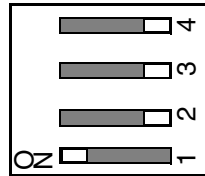

SW5

- S5-1 = on
- S5-2 = off
- S5-3 = off
- S5-4 = off

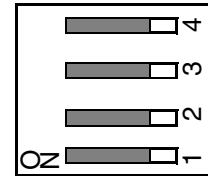

SW6

- S6-1 = off
- S6-2 = off
- S6-3 = off
- S6-4 = off



SW7

- S7-1 = on
- S7-2 = on
- S7-3 = on for production systems
off for development systems
- S7-4 = off

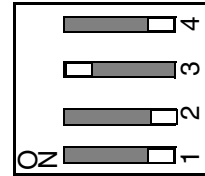

SW8

- S8-1 = off
- S8-2 = off
- S8-3 = on
- S8-4 = off

NOTE: When S7-3 is on, the SPARC-5V resets when the VCO/4K reboots.

Figure 2.9: SPARC CPU5V Switch Settings

4. Install the SPARC CPU/Sbus assembly and Storage Subsystem. These components are installed in the SS7 Shelf, as shown in Figure 2.10.

Note that the cards are installed horizontally. Rotate the CPU/Sbus assembly 90° counterclockwise, and install it in slots 1 and 2. Rotate the Storage Subassembly 90° counterclockwise, and install it in slots 3 and 4.

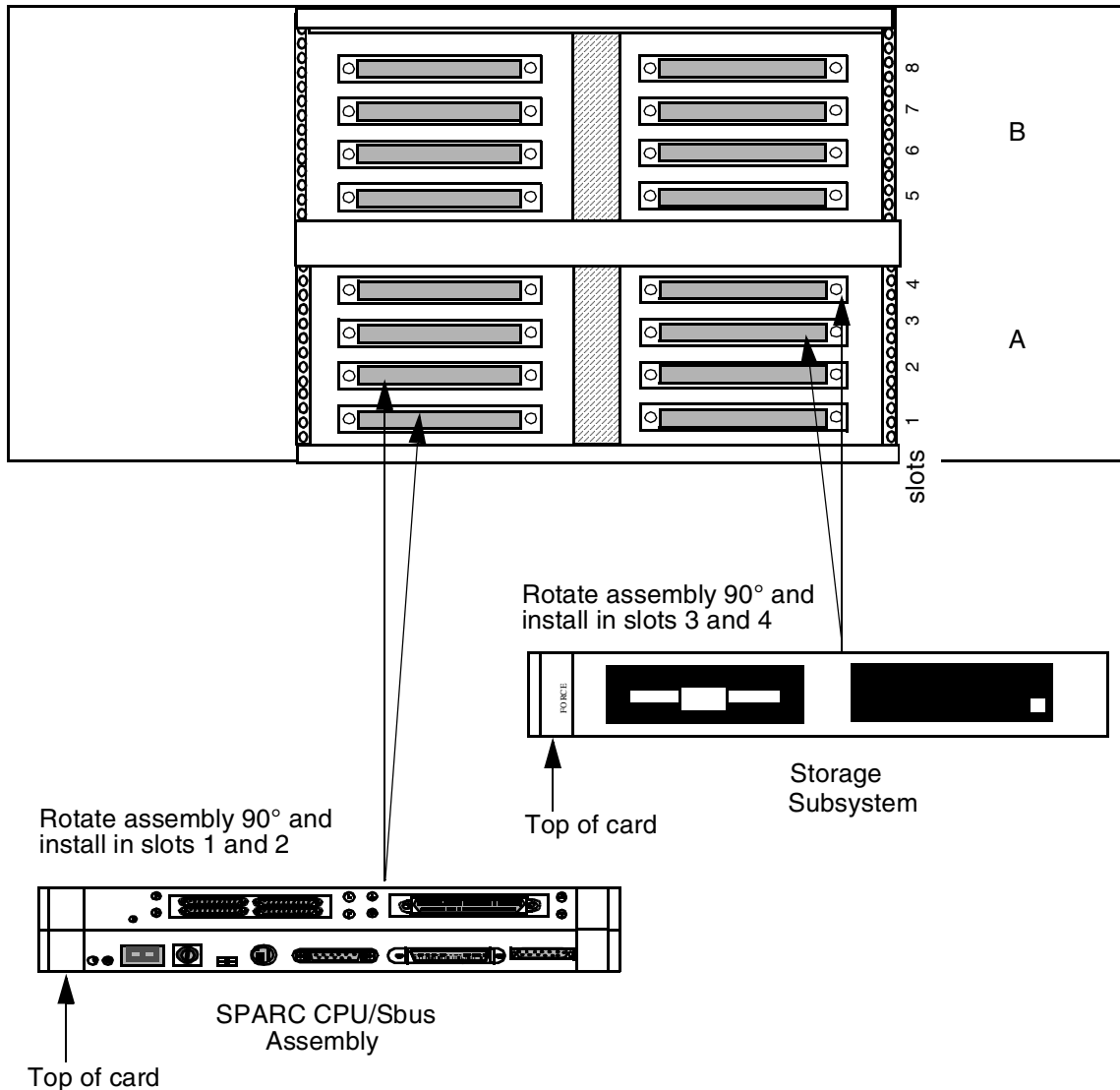

Figure 2.10: Installation of SPARC CPU/Sbus Assembly and Storage Subsystem: VME SS7 Shelf

NOTE: When attaching cables, make sure you tighten all jack screws and other locking mechanisms to secure cables in place.

5. Locate the LAN A cable (D-15 male) on the bottom right inside wall of your shelf (see Figure 2.11).
6. Connect the D-15 male connector to the Ethernet port of your SPARC CPU (see Figure 2.12).
7. Connect and lock into place a shielded Ethernet AUI cable or Ethernet transceiver to the D-15 female locking connector labeled E-A on the back distribution panel, as shown in Figure 2.13.
8. Connect to your LAN.

*NOTE: You **must** use shielded cables for your Ethernet AUI connections.*

NOTE: The Integrated SS7 system, VCO/4K, and host(s) must all be on the same IP subnet.

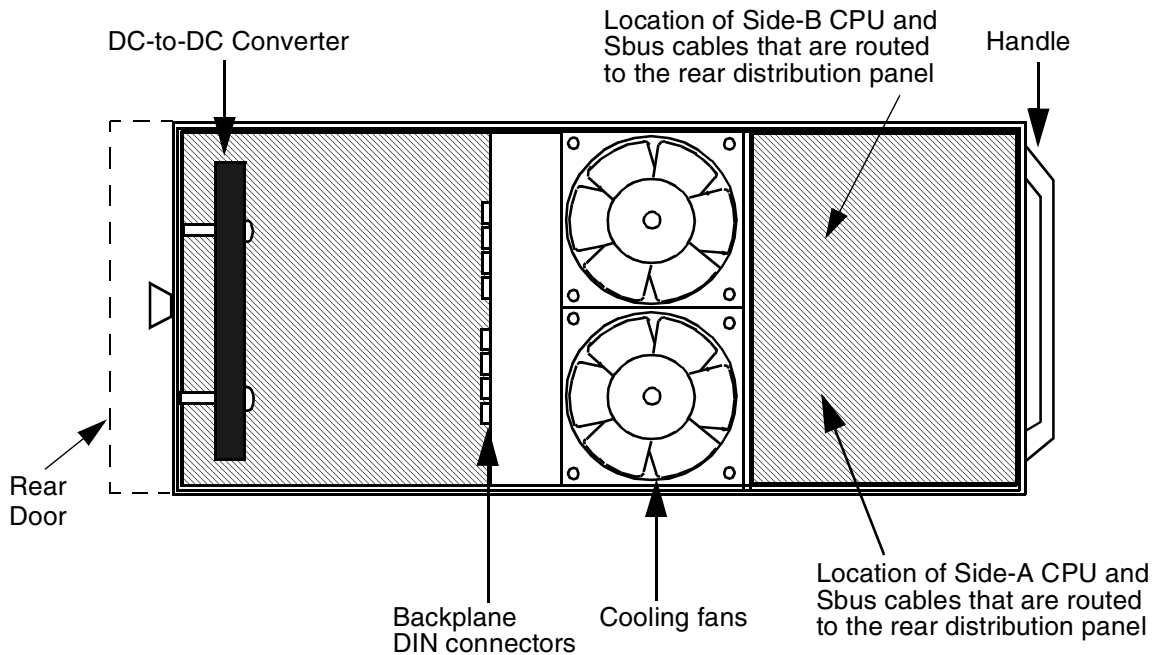

Figure 2.11: Cutaway Side View

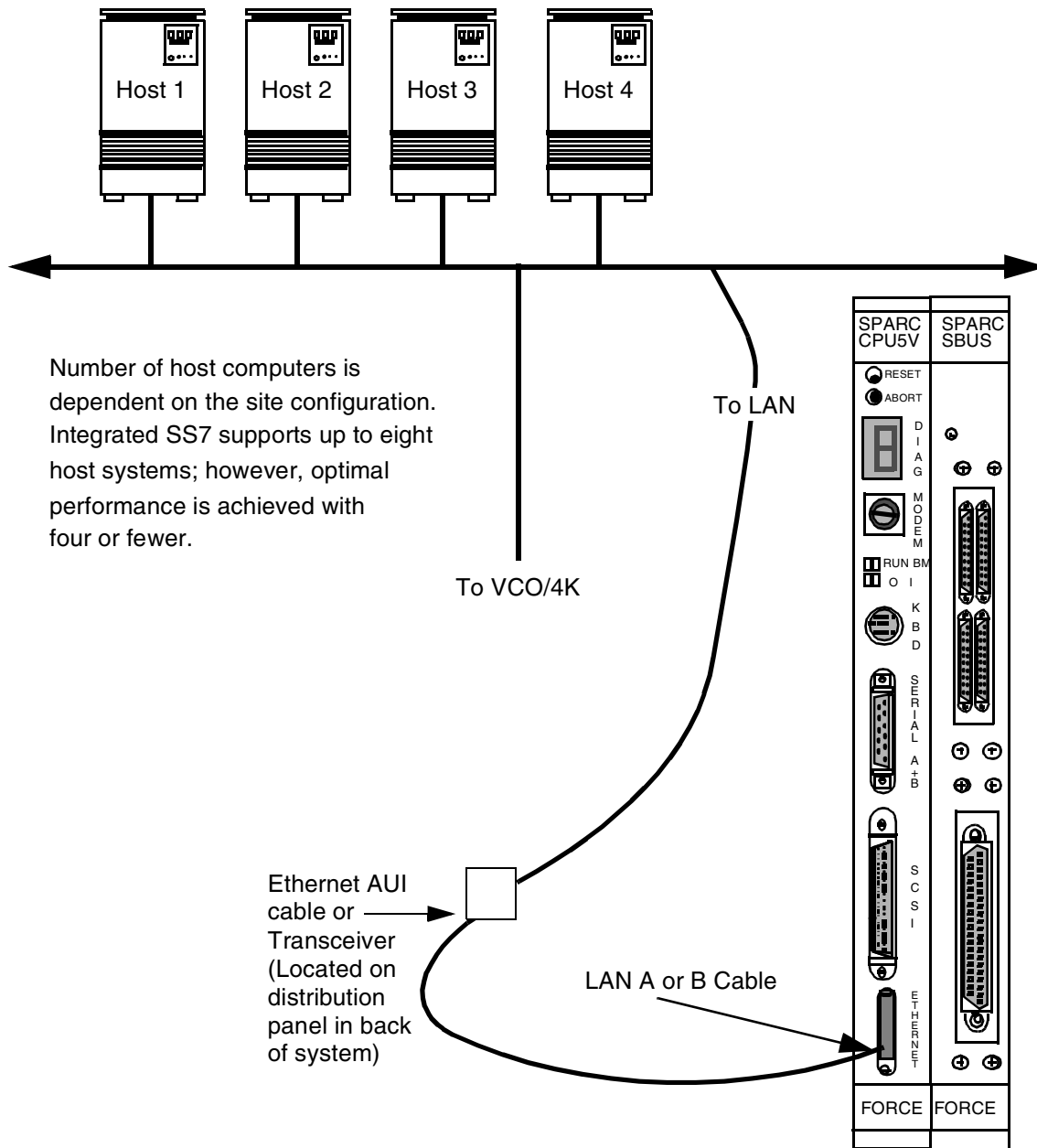

Figure 2.12: Ethernet Pathway

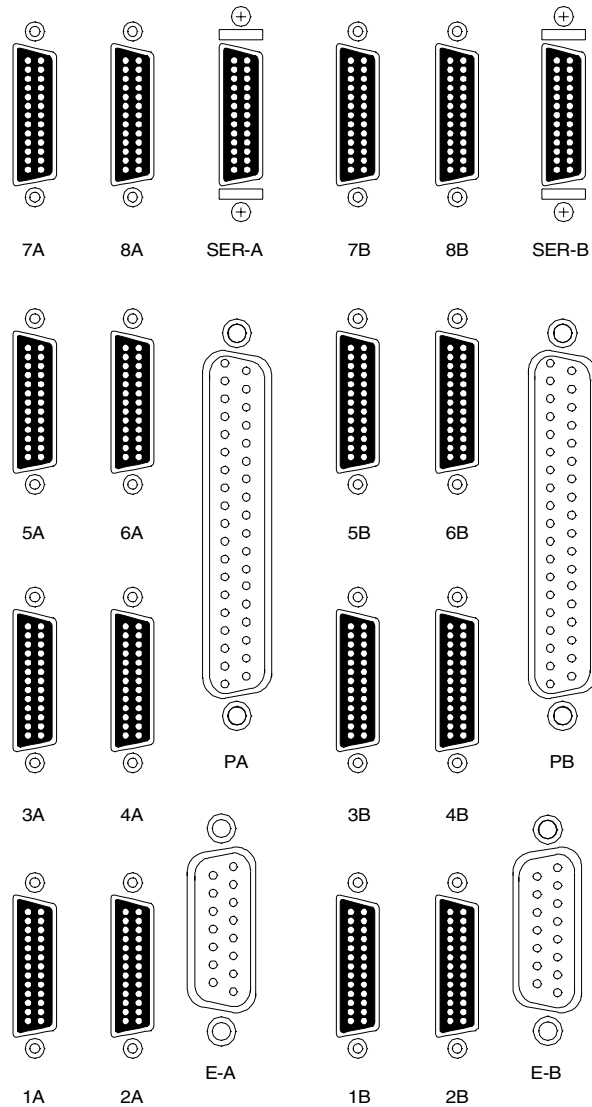

Figure 2.13: SS7 Shelf Rear Distribution Panel

9. Locate the A-side SS7 link ribbon cables (micro D-26 male) located in the internal ribbon-cable bundle on the bottom right inside wall of your shelf. The cables should be labeled 1A through 4A, then 5A through 8A for 8 links.

Connect the micro D-26 male end of the first cable (1A) to port 1 on the Sbus card. The associated micro D-26 female end of the cable located on the rear distribution panel (refer to Figure 2.13) is labeled identically.

NOTE: If your site has only one link to the SS7 network, it must connect to the Sbus Port 1.

If your site has more than one SS7 network link, connect the micro D-26 male end of the additional cables to their respective ports (ports 2 to 4 or 2 to 8) on the Sbus card, as shown in Figure 2.14 or Figure 2.15. The micro D-26 female ends located on the rear distribution panel (refer to Figure 2.13) are labeled identically (2A through 8A).

10. Locate the SS7 link cables (micro D-26 male to DB-37 male) and connect the micro D-26 end(s) of the cable(s) to the appropriate location(s) on the rear distribution panel. Connect the DB-37 end(s) of the cable(s) to the link(s) for your SS7 network.

NOTE: If your site has more than one link, pay close attention to which physical Sbus port location you are using for each SS7 network link. This information is required to configure the system later in the installation.

Cisco Systems strongly recommends clearly labeling both ends of each cable with the physical port location (1A to 8A).

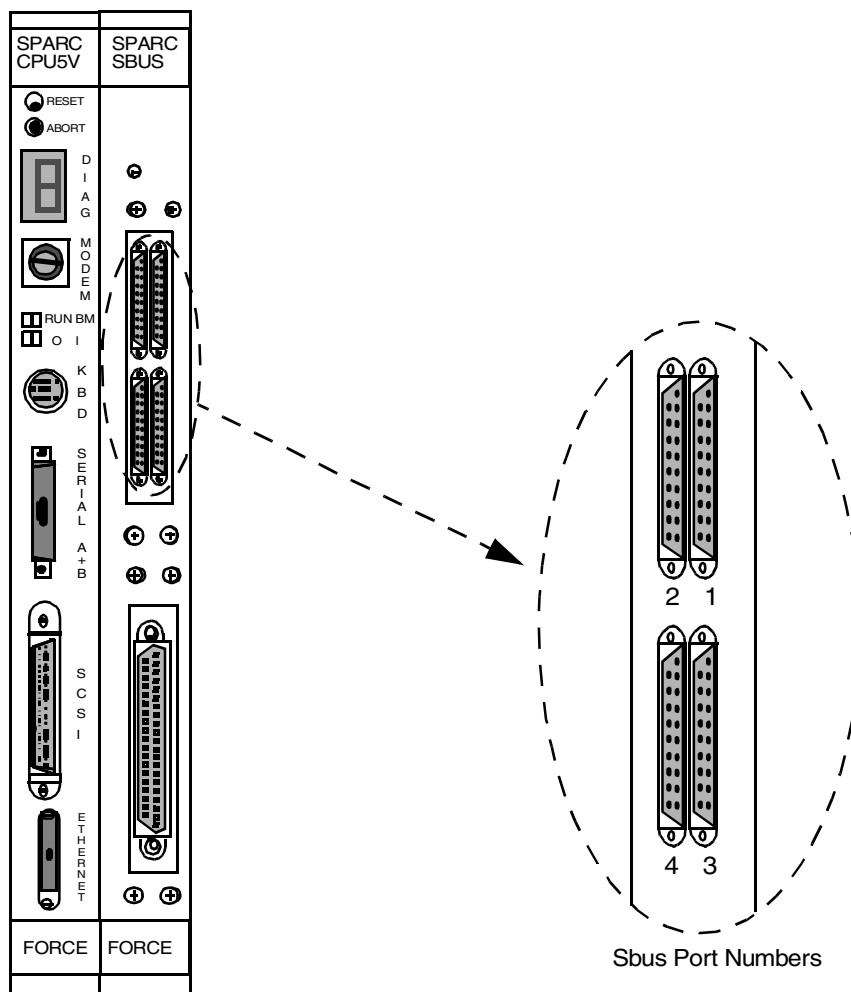

Figure 2.14: SS7 Network Link Connections (4-link)

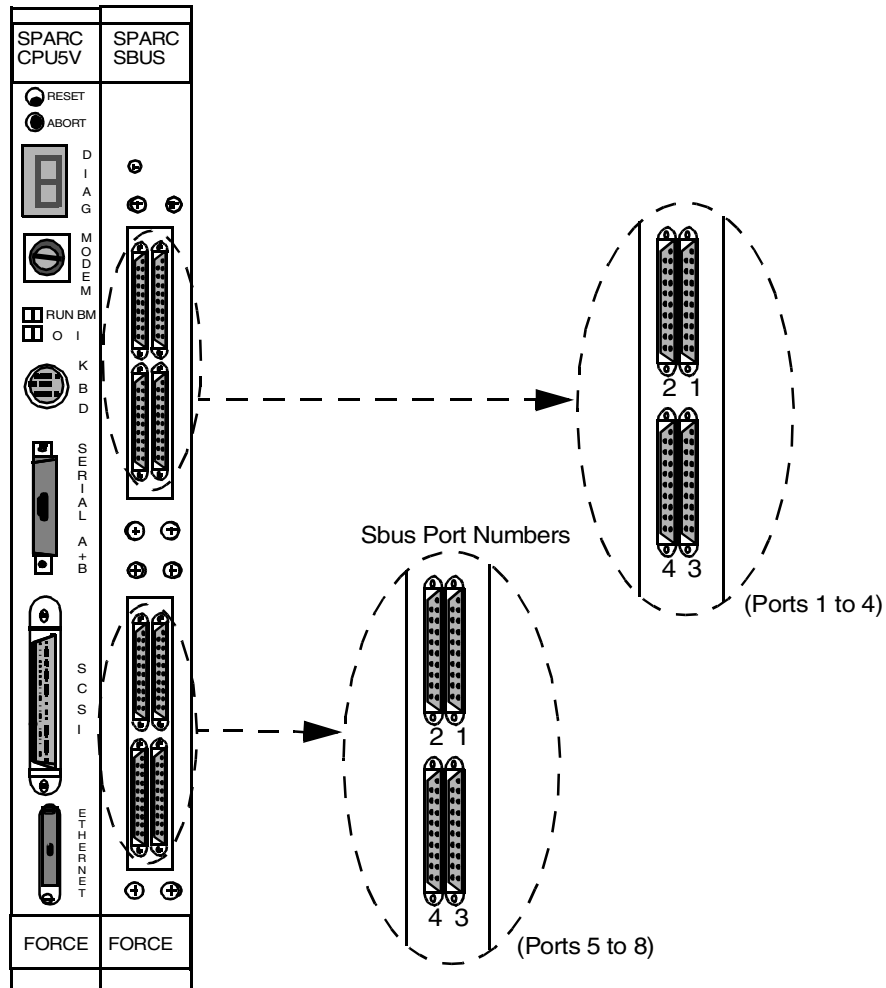

Figure 2.15: SS7 Network Link Connections (8-link)

2.6 INSTALLING PERIPHERALS: NON-REDUNDANT SYSTEMS

This subsection describes how to install the peripherals on non-redundant systems. If you have a redundant system, skip this section.

To install the Integrated SS7 peripherals on non-redundant systems, complete the following steps:

NOTE: When attaching cables, make sure you tighten all jack screws and other locking mechanisms to secure cables in place.

1. Locate the Serial A ribbon cable (micro D-26 male) located in the internal ribbon-cable bundle on the bottom right inside wall of your shelf.
2. Connect the micro D-26 male end of the cable to the SPARC CPU port labeled Serial A+B, as shown in Figure 2.16.

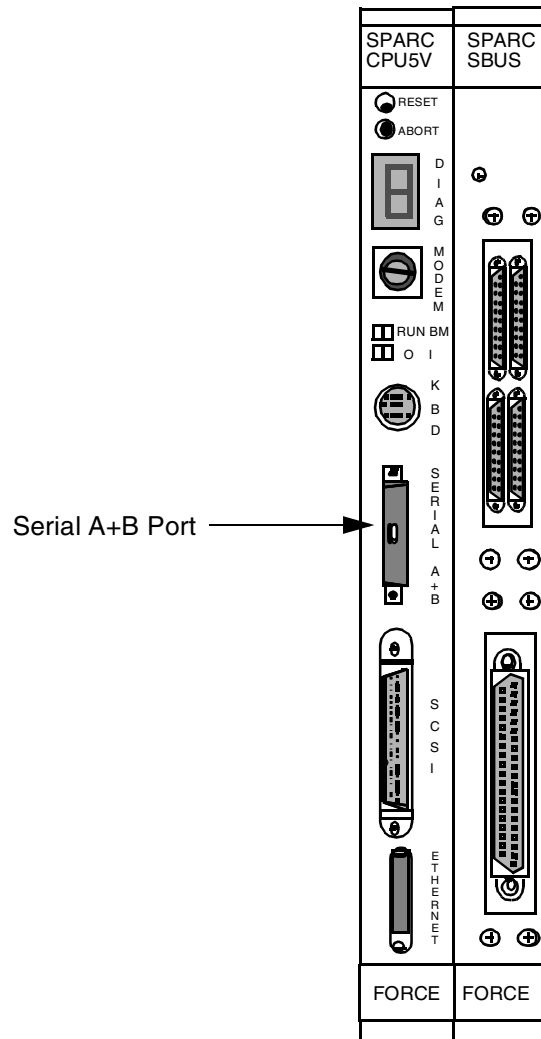

Figure 2.16: Serial A+B Port Location

3. Locate the two-way splitter cable:
 - a. Connect the single DB-25 end to the micro D-26 female connection labeled SER-A on the rear distribution panel.
 - b. Connect the DB-25 end labeled A to the ASCII terminal via the null cable or null modem, as shown in Figure 2.17.
 - c. Leave the end labeled B disconnected; it is used in redundant configurations.

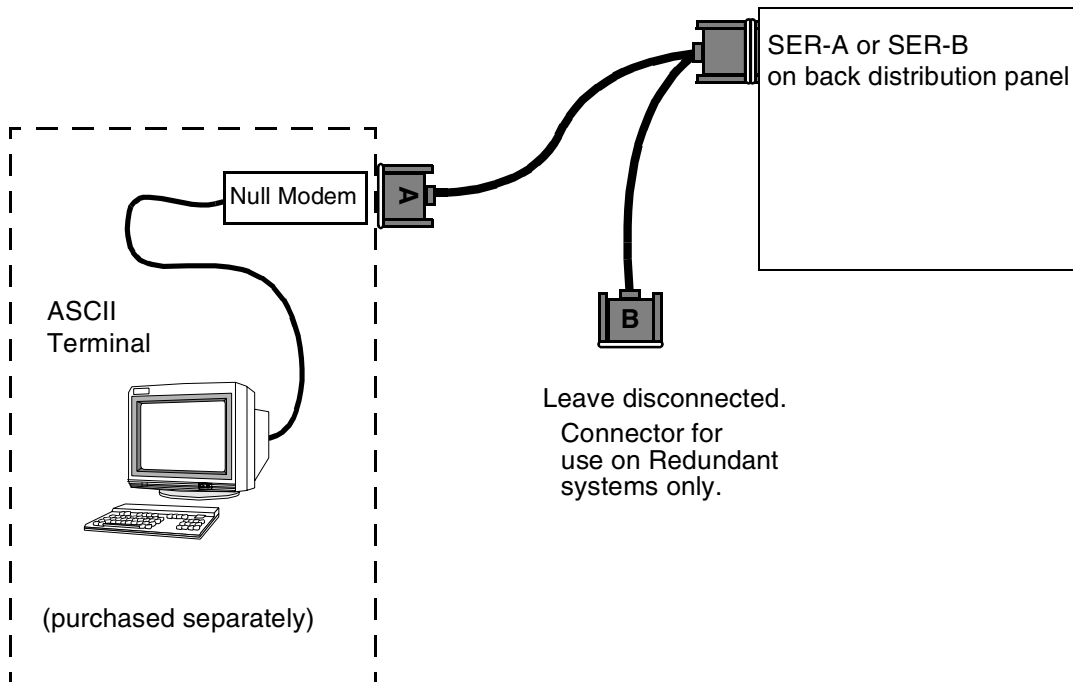

Figure 2.17: ASCII Terminal Connections

NOTE: When configuring the ASCII terminal, use VT100 Emulation. Also, use data settings of 9600 baud, eight bit, no-parity, and one stop bit.

CAUTION: Attaching a terminal to the SS7 SPARC serial port can cause an SS7 reboot/halt under certain failure conditions. This complication is in the Solaris operating system, which hangs when the VT console is either powered down or has a power supply failure.

Cisco Systems recommends disconnecting the VT terminal from the SPARC processor serial connection and either (a) reconnecting for active use only, or (b) leaving disconnected and performing all terminal functions via a Telnet session from the host or another connectivity device.

NOTE: Step 4 and Step 5 are unnecessary for 8-link systems. Instead, you must arrange dial-up to a local network and Telnet access to the SS7 subsystem.

4. Locate and set up the modem according to the instructions in the manufacturer's user documentation.
5. To connect the modem to the system:
 - a. Locate the ribbon cable labeled PA (DB-37) located in the internal ribbon-cable bundle on the bottom right inside wall of your shelf.
 - b. Connect the end of the cable to the serial port on the Sbus.
 - c. Locate and connect the DB-37 end of the three-way splitter cable to the DB-37 connector labeled PA on the rear distribution panel (see Figure 2.13).
 - d. Locate the 25-foot EIA/TIA-232 cable.
 - e. Locate the TTY0 connector on the three-way splitter. Connect the DB-25 female end of the EIA/TIA-232 cable to TTY0 (see Figure 2.18).
 - f. Connect the DB-25 male end of the 25-foot EIA/TIA-232 cable to the modem.

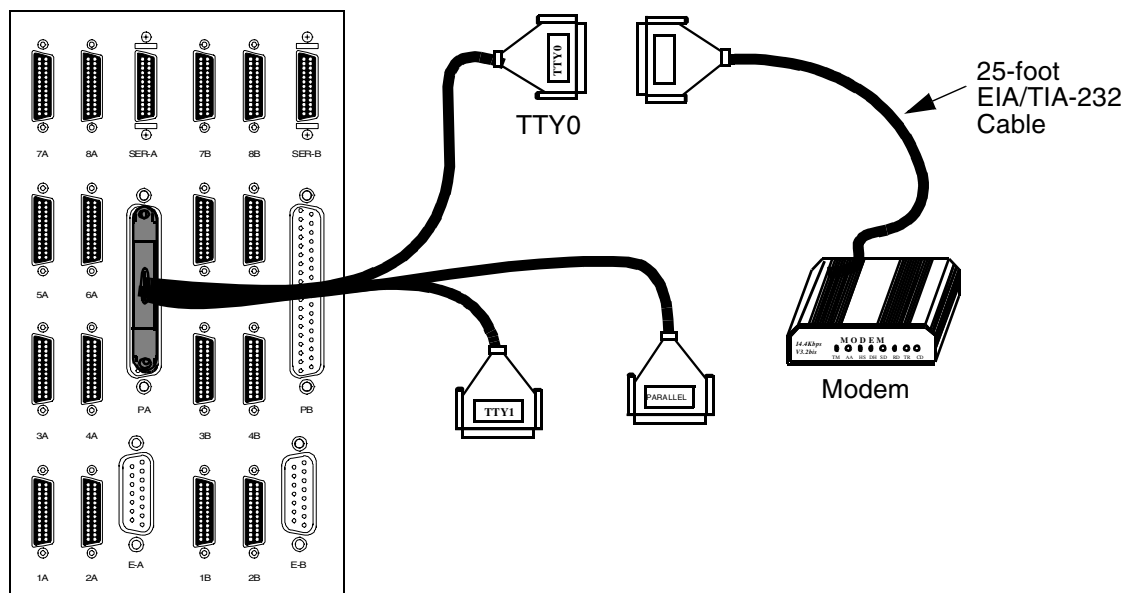

Figure 2.18: Modem Drive Connections

NOTE: Step 6 is optional. The CD-ROM drive is only needed to re-install Solaris.

6. To connect the CD-ROM drive to the system:
 - a. Locate the CD-ROM drive's SCSI cable.
 - b. Connect one end of the SCSI cable to the SCSI port on the SPARC CPU (see Figure 2.19).
 - c. Connect the other end of the SCSI cable to the CD-ROM drive.
 - d. Set the SCSI address of the CD-ROM drive to a value of 6.

NOTE: The CD is not hot pluggable. The Integrated SS7 system must be re-booted before you can use the drive.

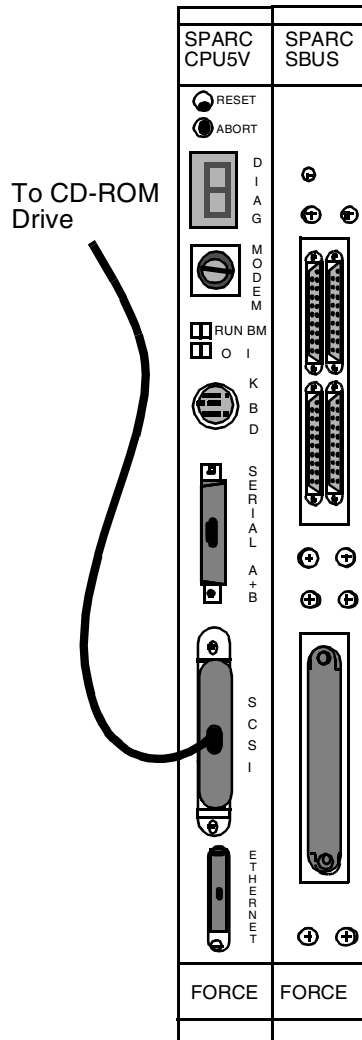

Figure 2.19: CD-ROM Drive Connections

7. Power up the VCO/4K according to the instructions in the *VCO/4K System Maintenance Manual*.
8. Power up the shelf by flipping the A-side power switch on (upward). See Figure 2.5 for the location of the power switch.

This completes the hardware installation process for non-redundant systems.

NOTE: Make sure you remove the CD-ROM and its associated cable after completing your software download process. Close and resecure the front door after CD-ROM removal. The front door must be closed in order to meet NEBS and EMI compliance.

2.7 INSTALLING CARDS AND LINKS: SIDE B OF REDUNDANT SYSTEMS

This section describes how to install the cards on side B of redundant systems.

CAUTION: Observe antistatic precautions when handling the cards to avoid damaging sensitive CMOS devices. Wear a ground strap connected to the grounded system equipment frame whenever dealing with system components.

1. Remove the second SPARC CPU/Sbus assembly from its packaging.

Verify that the DIP switches are set correctly.

CAUTION: If the DIP switch settings are not correct on the SPARC CPU5V, the VCO/4K database gets corrupted. This applies to both redundant and non-redundant systems.

Figure 2.8 shows the location of the switches on a SPARC CPU5V. Figure 2.9 shows the correct setting for each switch.

2. Install the second SPARC CPU assembly and Storage Subsystem into side B of the SS7 shelf as shown in Figure 2.20.

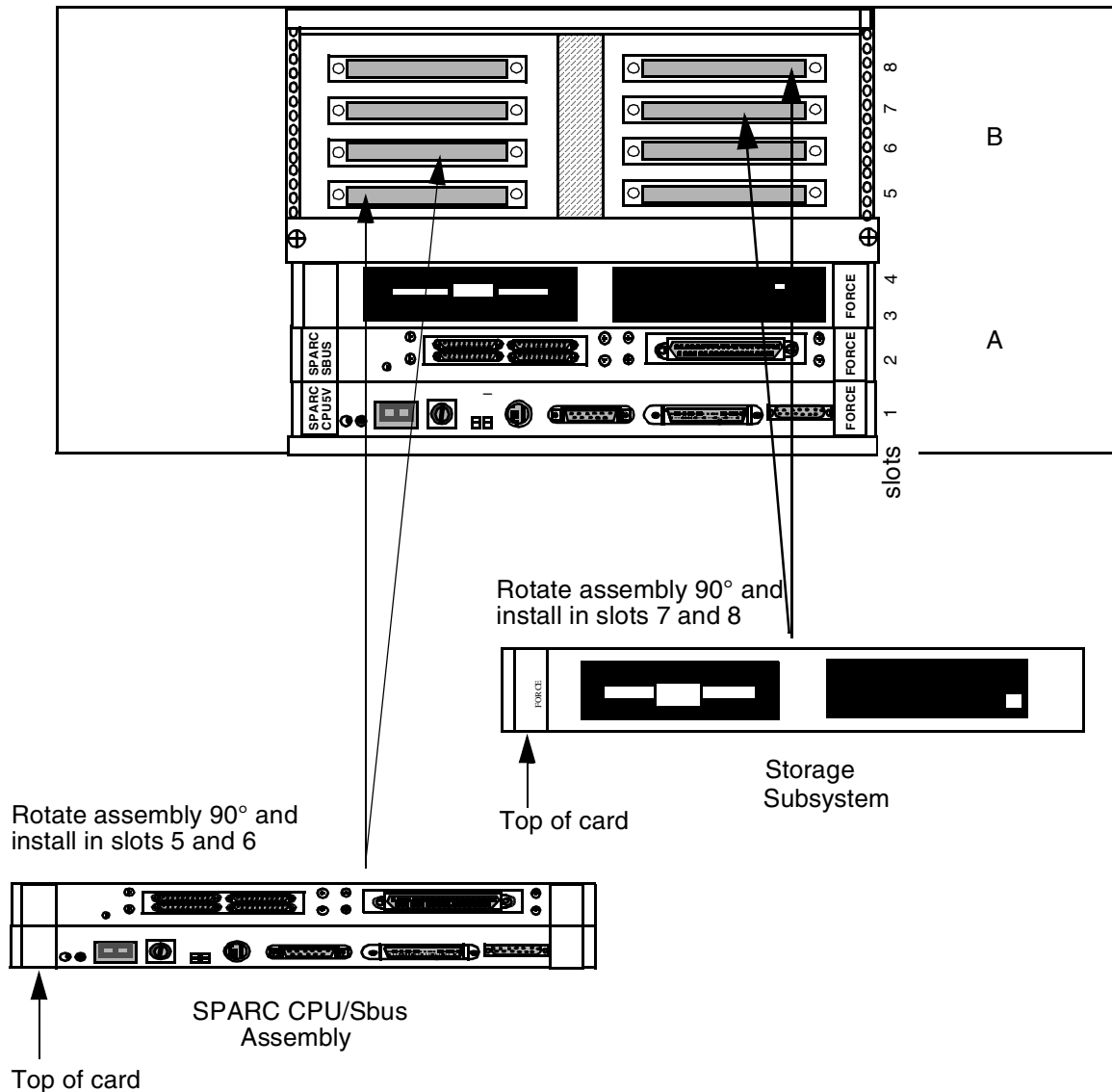

Figure 2.20: Assembly and Storage Subsystem Installation: Side B VME SS7 Shelf

NOTE: When attaching cables, make sure you tighten all jack screws and other locking mechanisms to secure cables in place.

3. Locate the LAN B cable (D-15 male) on the top right inside wall of your shelf.
4. Connect the D-15 male connector to the Ethernet port of your B-side (top) SPARC CPU (see Figure 2.12).
5. Connect and lock into place a shielded Ethernet AUI cable or Ethernet transceiver to the D-15 female locking connector labeled E-B on the back distribution panel, as shown in Figure 2.13.

6. Connect to your LAN.

*NOTE: You **must** use shielded cables for your Ethernet AUI connections.*

NOTE: The Integrated SS7 system, VCO/4K, and host(s) must all be on the same IP subnet.

7. Locate the B-side SS7 link ribbon cables (micro D-26 male) located in the internal ribbon-cable bundle on the top right inside wall of your shelf. The cables should be labeled 1B through 4B, then 5B through 8B for 8 links.

Connect the micro D-26 male end of the first cable (1B) to port 1 on the Sbus card. The associated micro D-26 female end of the cable located on the rear distribution panel (refer to Figure 2.13) is labeled identically.

NOTE: If your site has only one link to the SS7 network, it must connect to the Sbus Port 1.

If your site has more than one SS7 network link, connect the micro D-26 male end of the additional cables to their respective ports (ports 2 to 4 or 2 to 8) on the Sbus card, as shown in Figure 2.14 or Figure 2.15. The micro D-26 female ends located on the rear distribution panel (refer to Figure 2.13) are labeled identically (2B through 8B).

8. Locate the SS7 link cables (micro D-26 male to DB-37 male) and connect the micro D-26 end(s) of the cable(s) to the appropriate location(s) on the rear distribution panel. Connect the DB-37 end(s) of the cable(s) to the back of your SS7 selector switch, as described in *Section 2.9*.

NOTE: If your site has more than one link, pay close attention to which physical Sbus port location you are using for each SS7 network link. This information is required to configure the system later in the installation.

Cisco Systems strongly recommends clearly labeling both ends of each cable with the physical port location (1B to 8B).

Figure 2.21 shows the front view of a redundant SS7 system with the door open.

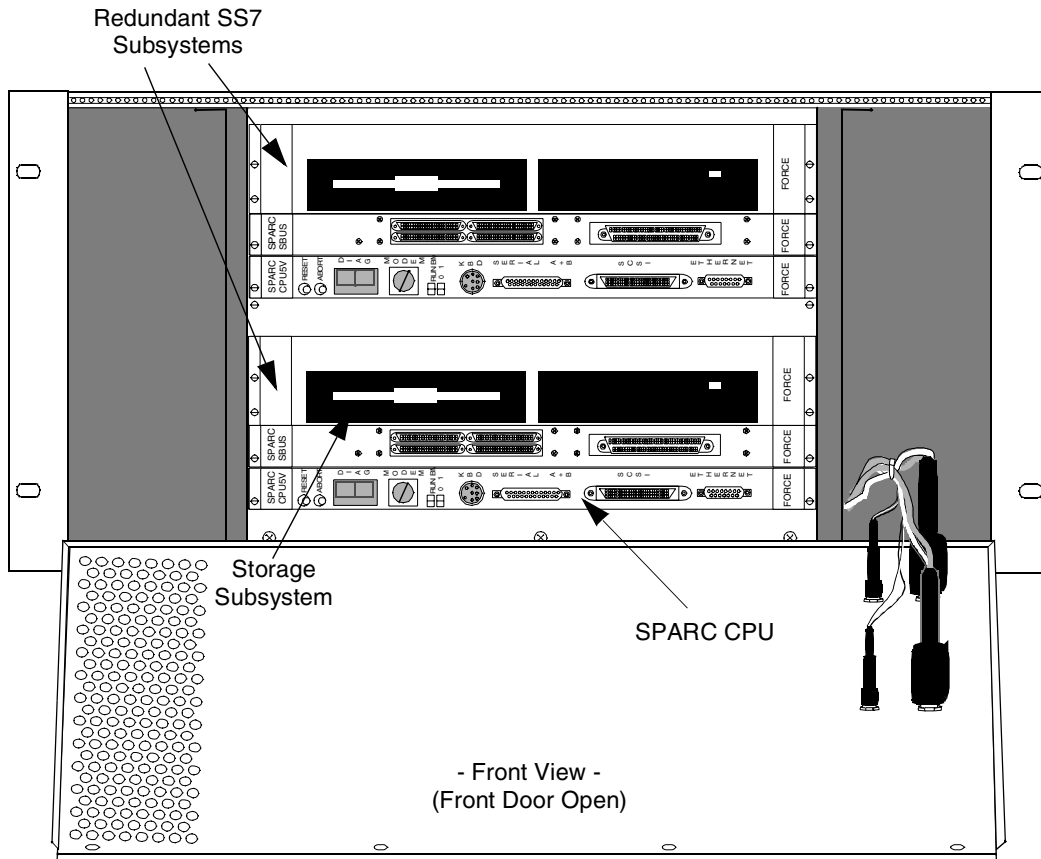

NOTE: Cable harness is left out out for visual clarity.

Figure 2.21: Front View of Redundant SS7 System

2.8 INSTALLING PERIPHERALS: REDUNDANT SYSTEMS

This subsection describes how to install the peripherals on redundant systems. First, follow the directions in *Section 2.6* to install the Integrated SS7 peripherals on Side A. Then, complete the following steps:

NOTE: When attaching cables, make sure you tighten all jack screws and other locking mechanisms to secure cables in place.

1. Locate the Serial B ribbon cable (micro D-26 male) located in the internal ribbon-cable bundle on the top right inside wall of your shelf.
2. Connect the micro D-26 male end of the cable to the B-side SPARC CPU (top) port labeled Serial A+B, as shown in Figure 2.16.
3. Locate the two-way splitter cable:
 - a. Connect the single DB-25 end to the micro D-26 female connection labeled SER-B on the rear distribution panel.
 - b. Connect the DB-25 end labeled A to the ASCII terminal via the null cable or null modem, as shown in Figure 2.17.
 - c. Leave the end labeled B disconnected.

NOTE: When configuring the ASCII terminal, use VT100 Emulation. Also, use data settings of 9600 baud, eight bit, no-parity, and one stop bit.

CAUTION: Attaching a terminal to the SS7 SPARC serial port can cause an SS7 reboot/halt under certain failure conditions. This complication is in the Solaris operating system, which hangs when the VT console is either powered down or has a power supply failure.

Cisco Systems recommends disconnecting the VT terminal(s) from the SPARC processor serial connection and either (a) reconnecting for active use only, or (b) leaving disconnected and performing all terminal functions via a Telnet session from the host or another connectivity device.

*NOTE: **Step 4 and Step 5 are unnecessary for 8-link systems.** Instead, you must arrange dial-up to a local network and Telnet access to the SS7 subsystem.*

4. Set up the modem and A/B transfer switch following the instructions in the manufacturers' documentation.

NOTE: Cisco Systems recommends a separate modem to each side. Otherwise, the modem connection can hang periodically and be unusable. Follow directions from Section 2.6 for connecting directly to a modem.

5. To connect the modem to the redundant Integrated SS7 system (see Figure 2.22):
 - a. Remove the EIA/TIA-232 cable from the three-way splitter cable off of the PA connector on the rear distribution panel.
 - b. Connect the TTY0 connector of the the three-way splitter to the side A input at the back of the SS7 selector switch.
 - c. Locate the ribbon cable labeled PB (DB-37) located in the internal ribbon-cable bundle on the top right inside wall of your shelf.
 - d. Connect the D-37 female end of the cable to the serial port on the Side-B Sbus.
 - e. Locate and connect the DB-37 end of the three-way splitter cable to the DB-37 connector labeled PB on the rear distribution panel (see Figure 2.13).
 - f. Connect the TTY0 connector of the the three-way splitter to the side B input at the back of the A/B transfer switch.
 - g. Locate the 25-foot EIA/TIA-232 cable.
 - h. Connect the DB-25 end of the cable to the outgoing port of the A/B transfer switch.
 - i. Connect the EIA/TIA-232 end of the cable to the modem.

*NOTE: **Step 6 is optional.** The CD-ROM drive is only needed to re-install Solaris.*

6. Connect the CD-ROM drive to either side of the Integrated SS7 system by completing the following steps:
 - a. Locate the CD-ROM drive's SCSI cable.
 - b. Connect one end of the SCSI cable to the SCSI port on the SPARC CPU (see Figure 2.19).
 - c. Connect the other end of the SCSI cable to the CD-ROM drive.
 - d. Set the SCSI address of the CD-ROM drive to a value of 6.

NOTE: The CD is not hot pluggable. The Integrated SS7 system must be re-booted before you can use the drive.

NOTE: Make sure you remove the CD-ROM and its associated cable after completing your software download process. Close and resecure the front door after CD-ROM removal. The front door must be closed in order to meet NEBS and EMI compliance.

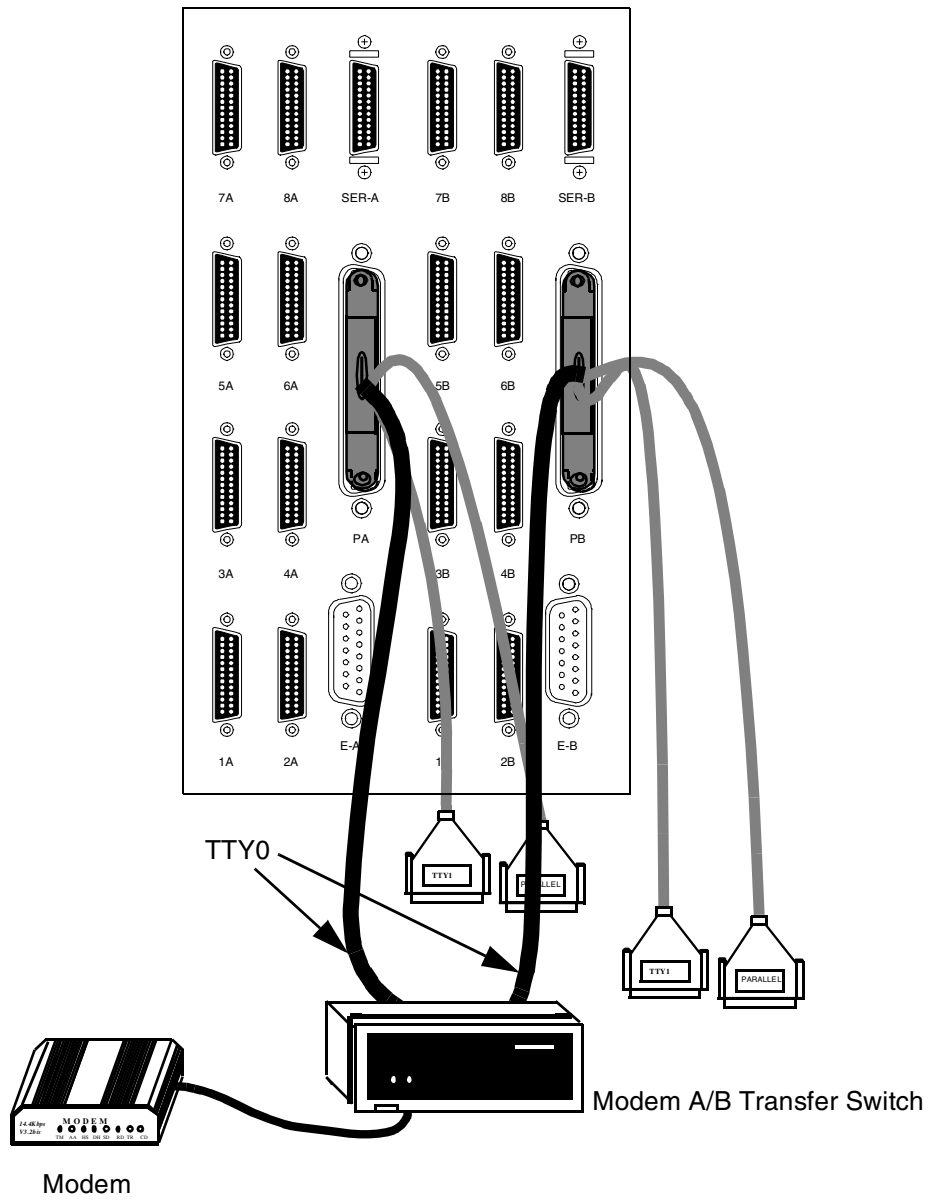

Figure 2.22: Modem Connections on Redundant Systems

2.9 INSTALLING SS7 SELECTOR SWITCH: REDUNDANT SYSTEMS

This subsection describes how to install the SS7 selector switch, which provides SS7 link redundancy connection to both side A and side B of the redundant configuration. The selector switch has redundant power supplies (see Figure 2.23).

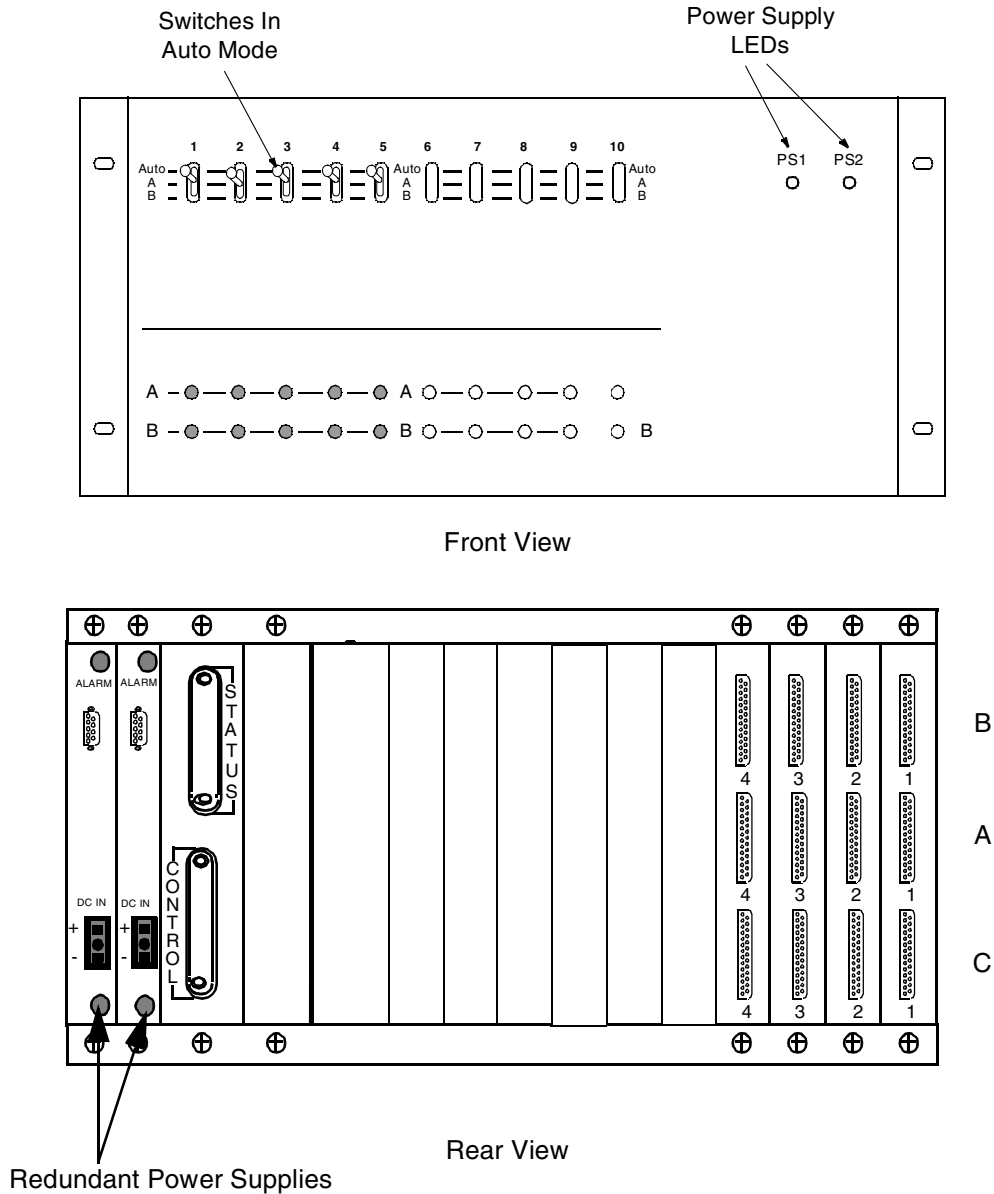

Figure 2.23: SS7 Selector Switch (4-link)

2.9.1 Specifications

Part Number:	Contact your Cisco Systems sales representative
Dimensions:	Height — 8.75 inches (22.23 cm) Depth — 8 inches (20.32 cm) Width — 19 inches (48.26 cm) Designed to mount in a 19" rack
Power Input:	-48 VDC — dual input
Compliance:	EMI/EMC FCC Part 15 (U.S. and Canada) EN55022/50082 (for Europe) NEBS GR-63-CORE (Issue 1, 1995) GR-1089-CORE (Issue 2, 1997) UL 1950 CSA C22.2 EN60950 (for Europe) IEC-950
Weight (max.):	8 lbs.
Operational Temperature Range:	40 to 100°F 10 to 40°C
Operational Temperature Gradient:	15°F (10°C) per hour
Operational Humidity:	20 to 80 percent (%), non-condensing
Operational Altitude:	0 to 10,000 ft 0 to 3,048 m

2.9.2 Installation

The selector switch is designed to mount in a 19-inch utility rack, -48 VDC device, which is separate from the VCO/4K. When installing in a site with AC power only, an AC-to-DC rectifier of sufficient DC output power is required.

CAUTION: Do not power the SS7 selector switch by the VCO/4K.

The required power for the empty chassis is 2 watts (maximum draw). Each board draws a maximum of 5 watts. For example, running 4 link cards in a chassis draws 20 watts, *plus* 2 watts for the chassis requirements, which equals a *total* of 22 watts.

The SPARC CPU/Sbus assembly must be properly installed in each side of the VCO/4K's control subrack before you begin to install the SS7 selector switch.

To install the SS7 selector switch, complete the following steps:

1. Install the SS7 selector switch in the utility rack.

NOTE: In addition to these components, the installation requires a separate 19-inch utility rack with its own -48 VDC source. These components must be purchased separately. If your site has AC power only, an AC-to-DC rectifier of sufficient DC output power must be used.

CAUTION: There is no power switch on the SS7 selector switch. The unit will power up as soon as input DC voltage is applied.

2. Attach building ground to the ground point (see Figure 2.26) on the rear of the SS7 selector switch. Use 14 AWG green/yellow stranded wire and an M4 lug. Attach the M4 lug to the SS7 selector switch ground point according to the stackup shown below (Figure). Use an adjustable torque wrench to tighten the nut to 13 to 18 in.-lb.

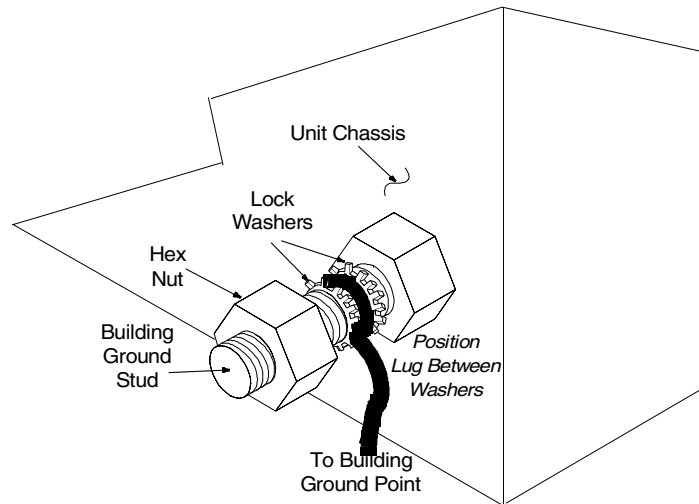

Figure 2.24: Ground Stud Stackup

3. Configure the -48 VDC power source (purchased separately) for the SS7 selector switch.

CAUTION: Disconnect the power supplying the feed circuit(s) that enter your SS7 selector switch. Tag the circuits at the disconnect points to warn others not to turn the power on while work is being completed. Leave the power feed disconnected until you have completed power source installation in the selector switch and are ready to test it.

4. Make two power cables for the SS7 selector switch.

NOTE: All selector switches are equipped with two DC-to-DC converters, which are identical and interchangeable. Due to current sharing, either converter can support a fully loaded system.

Cisco Systems supplies male three-pin connector mates for the end of your power cables. Use 14 AWG color-coded stranded wire. One wire is for -48 VDC, one wire is for -48 VDC return, and the final wire is a green/yellow ground wire, as shown below in Figure 2.25.

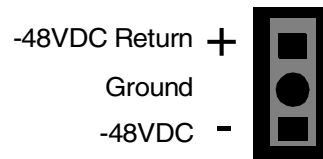

Figure 2.25: SS7 Selector Switch DC Power Inlet

5. Locate the Status/Control cable assembly.
 - a. Connect the Status/Control connectors to the rear of the SS7 selector switch as shown in Figure 2.26.
 - b. Connect the DB-25 end of the Status/Control cable (marked A side) to the Serial B connector off of the SER-A connector on the rear distribution panel of the Integrated SS7 system (see Figure 2.26).
 - c. Connect the DB-25 end of the Status/Control cable (marked B side) to the Serial B connector off of the SER-B connector on the rear distribution panel of the Integrated SS7 system (see Figure 2.26).

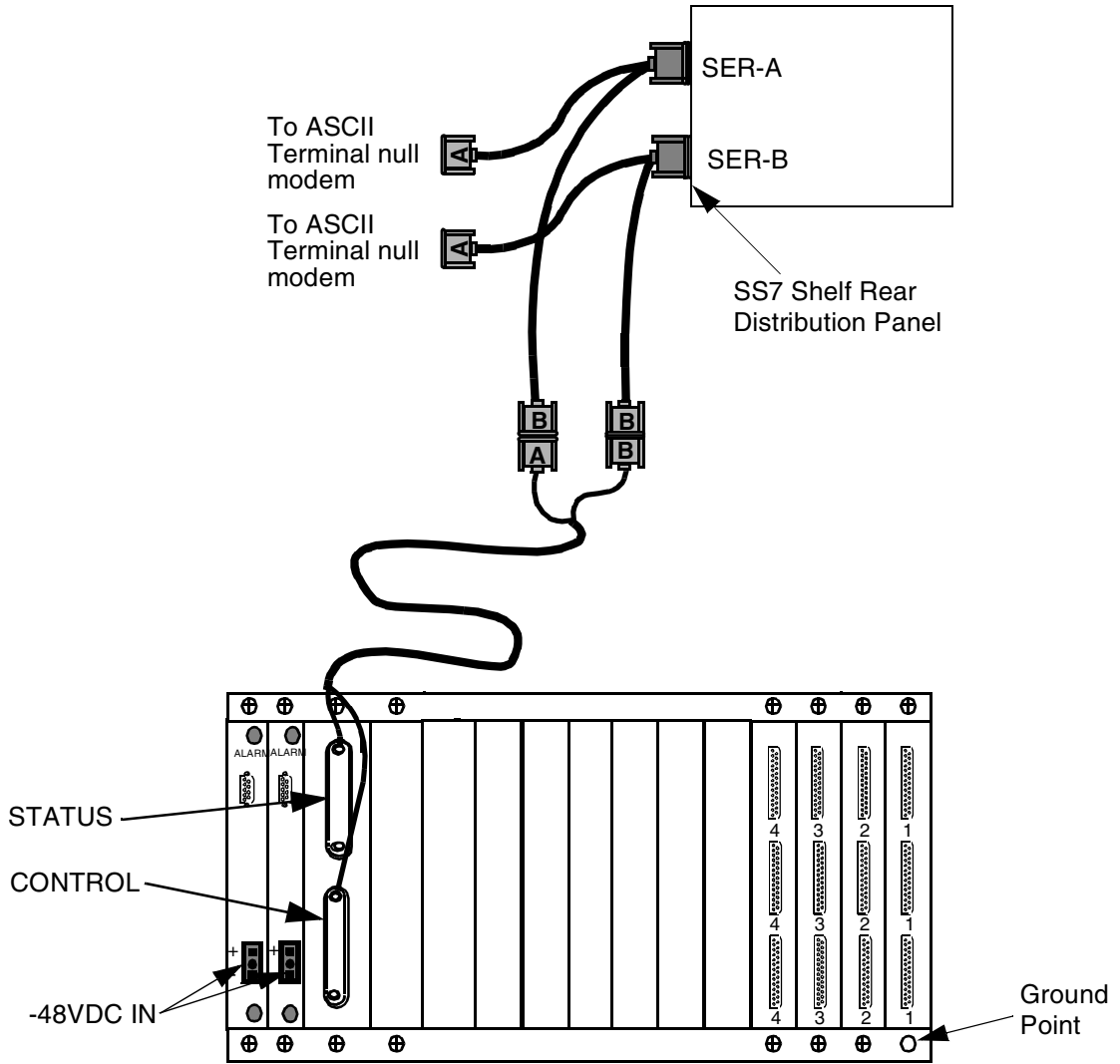

Figure 2.26: SS7 Selector Switch Status/Control Connections

6. Locate the DB-25 male to DB-37 female cables and connect the Integrated SS7 sides A and B to the SS7 selector switch as follows:
 - a. From the rear of the SS7 selector switch, connect the DB-25 male end of the first cable in position A-1, as shown in Figure 2.27.
 - b. Connect the DB-37 end of the first cable to the DB-37 end of the cable connected to the 1A connector off of the the rear distribution panel of the Integrated SS7 system.

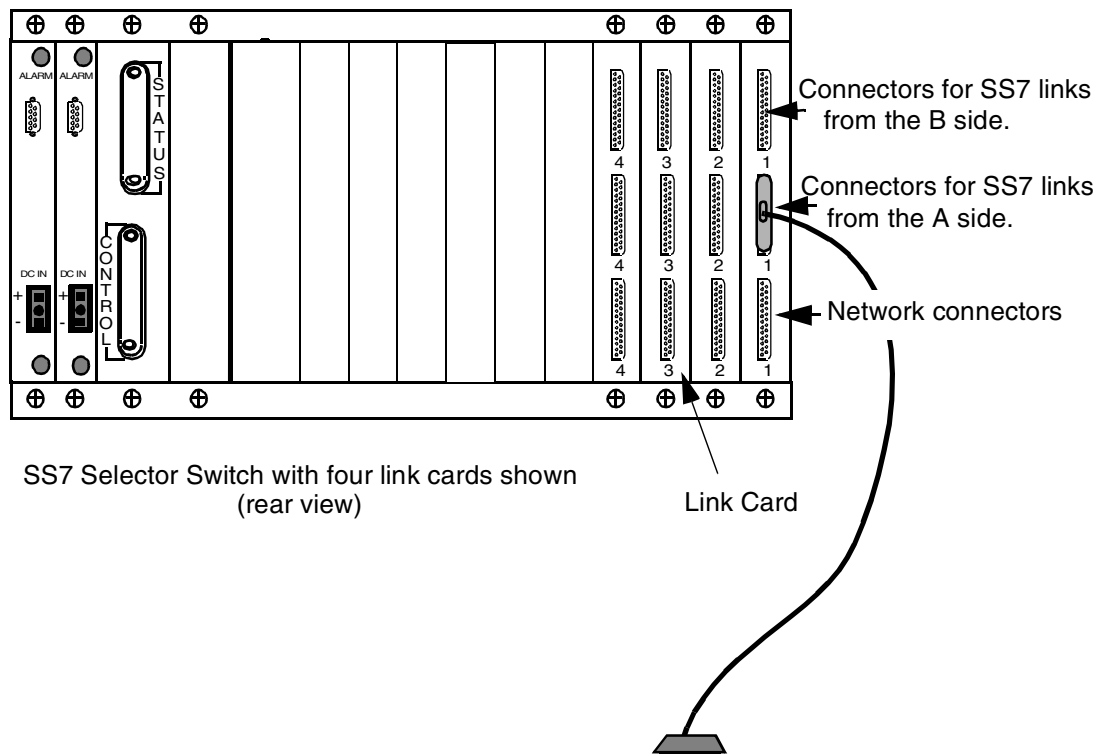

Figure 2.27: SS7 Selector Switch to Signaling Links

- c. Repeat step a and step b until all SS7 selector switch signaling links are connected on side A (2A through 4A and 5A through 8A).
- d. Connect the DB-25 male end of the next cable to position B-1 (see Figure 2.27).
- e. Connect the DB-37 end of the fifth (or ninth) cable to the DB-37 end of the cable connected to the 1B connector off of the the rear distribution panel of the Integrated SS7 system.
- f. Repeat steps d and e until all SS7 selector switch signaling links are connected on side B (2B through 4B and 5B through 8B).
- g. Locate the DB-25 male to DB-37 male cables.
- h. Connect the DB-25 male end of the first cable to position C-1 of the SS7 selector switch EIA/TIA-449 connectors labeled C (See Figure 2.27). Connect the DB-37 male end to your SS7 network.
- i. Repeat step h until all of the SS7 selector switch signaling links labeled C are connected to your SS7 network.

7. Go to the front of the SS7 selector switch and put the A/B toggle switch in the AUTO position, as shown in Figure 2.28, for each link connected.

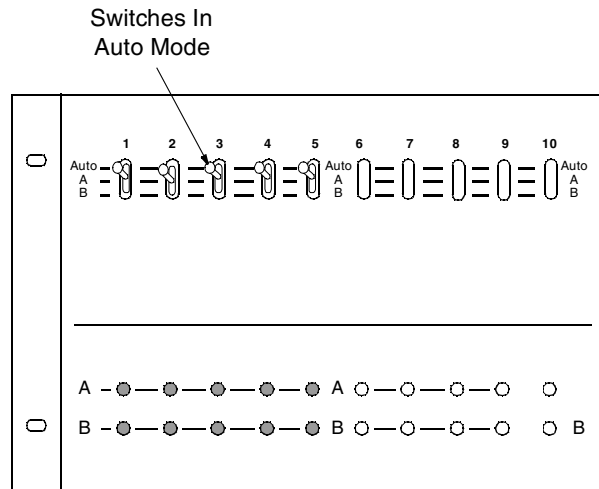

Figure 2.28: SS7 Selector Switch A/B Toggle Switch Position

NOTE: Keep the A/B toggle switch in the AUTO position during normal operation. When performing maintenance on the links, this switch can be used to lock the SS7 selector switch on side A or side B after you initiate a switchover as described in Section 5.6. Do not use the A/B toggle switch to initiate a switchover.

8. Reconnect the power supplying the feed circuit(s) that enter your SS7 selector switch.
9. Toggle the SS7 VME shelf A-side and B-side power switches to the on position (up).

NOTE: Remember, the SS7 selector switch powered on when input DC voltage was applied.
10. Power up the VCO/4K, following the instructions in the *VCO/4K System Maintenance Manual*.

SECTION 3 SOFTWARE INSTALLATION AND NETWORK CONFIGURATION

3.1 INTRODUCTION

The software is loaded on the Integrated SS7 system hard drive at the factory. However, when you boot your system for the very first time, the **sys-config** script runs automatically to configure the system on the network. The **sys-config** script performs the following tasks:

- Adds the Integrated SS7 system's hostname and IP address to the **/etc/hosts** file
- Sets the hostname in **/etc/rc.boot**
- Sets the domain name in **/etc/rc.single**
- Sets the **/usr/lib/zoneinfo/localtime** file
- Enables NIS if Network Information Services are requested

After **sys-config** executes, you must edit the Integrated SS7 system's **/etc/hosts** file to include the hostnames and IP addresses of the systems connected to the Integrated SS7 system. These systems include the VCO/4K, hosts and, if you have a redundant configuration, the second Integrated SS7 system.

3.1.1 Network Information Worksheets

Before you boot the system, make copies of the following Network Information worksheets and fill them out with the assistance of your network administrator. If you have any questions, contact Cisco Systems Technical Support for assistance.

CAUTION: If any of this information is entered incorrectly, the system will not boot. Solaris is case sensitive.

Save the worksheets after you have completed the instructions in this section. You will need this information to configure the TUP software components as described in *Section 4.3*.

Network Information Worksheet 1

Non-Redundant Configurations

Integrated SS7 system hostname _____
Integrated SS7 system IP address _____
VCO/4K hostname _____
VCO/4K IP address _____
VCO/4K socket number _____

Redundant Configurations

SIDE A	SIDE B
Integ. SS7 hostname* _____	Integ. SS7 hostname* _____
Integ. SS7 IP address _____	Integ. SS7 IP address _____
VCO/4K hostname _____	VCO/4K hostname _____
VCO/4K IP address _____	VCO/4K IP address _____
VCO/4K socket number _____	VCO/4K socket number _____

All Configurations^f

Name service _____
Domain name _____
Name server hostname _____
Name server IP address _____
Netmask _____
Root password _____
Is the Integrated SS7 System part of a subnet**? ____

* These names must be the same except for the last character. The last character must be “a” for side A and “b” for side B.

^f Use the same values for both sides of redundant configurations.

** In non-redundant configurations, we recommend the Integrated SS7 System, VCO/4K, and host all be on the same IP subnet.

In a redundant configuration, *Cisco Systems recommends* the Integrated SS7, VCO/4K, and host for side A be on the same IP subnetwork. The same is true for the systems on side B. The two sides can be on separate subnetworks, but the Integrated SS7 systems must be able to communicate with each other over the Ethernet. The side A host and side B host must be capable of routing Ethernet packets between the two subnetworks.

Network Information Worksheet 2

Application Host Information^f

Host 1 hostname _____
Host 1 IP address _____
Host 1 socket number _____
Host 2 hostname _____
Host 2 IP address _____
Host 2 socket number _____
Host 3 hostname _____
Host 3 IP address _____
Host 3 socket number _____
Host 4 hostname _____
Host 4 IP address _____
Host 4 socket number _____
Host 5 hostname _____
Host 5 IP address _____
Host 5 socket number _____
Host 6 hostname _____
Host 6 IP address _____
Host 6 socket number _____
Host 7 hostname _____
Host 7 IP address _____
Host 7 socket number _____
Host 8 hostname _____
Host 8 IP address _____
Host 8 socket number _____

^f Use the same values for both sides of redundant configurations.

3.1.2 Special Considerations For On-Line Help

The script has on-line Help, which you can access at any time by pressing **F6**. When the on-line Help first comes up, the following message appears:

```
If you choose F3 to change your entries, you will go back only
to the screens shown in the summary. To change previously-
confirmed information, you must halt and reboot your system
(i.e., boot).
```

Do not use the reboot method to change information after it has been confirmed. In some cases, the system will loop back to the middle of the installation script and you will be unable to reenter the desired data.

To correct or change information after it has been confirmed, complete the following steps:

1. Finish running the installation script using the default values.
2. Reboot the system.
3. Log in as **root**.
4. Change directory to **/usr/sbin**.
5. Enter the following command and press **Return**:

```
sys-unconfig
```

The following message appears:

```
This program will unconfigure your system. It will cause it
to revert to a "blank" system - it will not have a name or know
about other systems or networks
```

```
This program will also halt the system.
```

```
Do you want to continue (y/n)?
```

6. Enter **y** and press **Return**. The system halts.
7. At the **ok** prompt, enter **boot** and press **Return**.

3.2 INSTALLATION CHECKLIST

This subsection summarizes the tasks that must be completed for an Integrated SS7 software installation. Items are listed in the order they should be completed.

NOTE: This list is independent of installing the VCO/4K generic software. Cisco Systems recommends that the VCO/4K generic software be completely installed prior to an SS7 software installation.

Software Installation Task List

1. Your Integrated SS7 software was already loaded before system shipment.
2. Run **sys-config** for A side and follow the screen prompts (see *Section 3.3*).
3. If redundant, connect console to B-side SPARC and boot B-side SPARC.
4. Run **sys-config** for B side and follow the screen prompts (see *Section 3.3*).
5. Create/edit the **/etc/hosts** file for both sides (see *Section 3.4*).
6. Configure E1/T1 spans on VCO/4K (see *VCO/4K System Administrator's Guide*):
 - Clear channel
 - Class of Service = 2
 - Impulse Rule = 0
 - Resource Groups
7. Test LAN and **/etc/hosts** via ping command from both sides if redundant system (see *Section 3.5*).
8. If you purchased the 2k-to-4k configurator and wish to run in 4K mode, install and run the configurator (see *Section 4.6*).
9. Build MTP layer MML files on A side (see *Section 4.3*).
10. Build TUP layer MML files on A side (see *Section 4.3*).
11. Create/build database area for NewNet using MML files on A side (see *Section 4.3*).
12. Log in as **root** to the Integrated SS7 system side A, **<hostname>a**.
 - a. Change permissions on the **.cshrc** script by entering the following command and pressing **Return**:

```
chmod 644 $HOME/.cshrc
```
 - b. Use a UNIX text editor to open the file **\$HOME/.cshrc** and add the following line:

```
setenv CC_CONFIG tup
```
13. Build the **\$XNV/CktInt.cfg** file on A side (see *Section 4.4.1*).
14. Build the **\$XNV/res_grp.cfg** file on A side (see *Section 4.4.1.1*).
15. Build the **\$XNV/tup_ckt_ss7_to_sds** file on A side (see *Section 4.4.2*).
16. Build the **\$XNV/tup_grp_ss7_to_sds** file on A side (see *Section 4.4.2.2*).
17. Configure for redundancy (see *Section 4.5*).
18. Start NewNet stack and cktint on A side (see *Section 5.2*).

19. *If redundant:*

- Copy all created files from above to B side and modify host names and VCO names as necessary (**skip Step 11 and Step 18**).

NOTE: Cisco Systems recommends using FTP to copy files from one side to the other (utilize LAN connection). Use UNIX command "man ftp" for assistance.

- Create/build database area for NewNet using MML files on B side.
- Start NewNet stack and cktint on B side (see *Section 5.2*).

20. Get data links up and aligned (**see note below**).

21. Pass SS7 messages to/from network (**see note below**).

22. *If redundant, test redundancy switchovers. (Make sure the SS7 data links can be aligned on one side, switch over and have these links align on the other side after the switch over.)*

NOTE: Cisco Systems will not be able to completely install/test the SS7 installation without an SS7 network connection. Only a customer-provided SS7 INET simulator can replace a network connection.

The level of testing performed by Cisco Systems Tech Support during an SS7 installation is minimal; it includes basic message passing (such as some circuit block messages) only.

If testing message passing to and from the network is critical, please contact the Cisco Systems Consulting group to assist with this work. This group has the technical expertise and required equipment to perform in-depth testing. In addition, the Consulting group can offer a package to help with turning up your application to the network and testing the MTP and TUP layers of the network (via simulation of the SS7 network and, in monitor mode, between the Cisco Systems SS7 system and the SS7 network).

3.3 RUNNING SYS-CONFIG

To prepare your system for operation, complete the following steps:

*NOTE: If your Integrated SS7 system console is a VT100 terminal, press **PF2** on the numeric keypad instead of the **F2** key.*

1. Power up the VCO/4K with the Integrated SS7 system installed.

NOTE: It is normal for the warning message, "Unable to determine keyboard type," to appear on the Integrated SS7's ASCII console when the system is powered up.

When the reboot completes, the Terminal Type screen, shown in Figure 3.1, appears:

```

-----
What type of terminal are you using?
1) ANSI Standard CRT
2) DEC VT52
3) DEC VT100
4) Heathkit 19
5) Lear Siegler ADM31
6) PC Console
7) Sun Command Tool
8) Sun Workstation
9) Televideo 910
10) Televideo 925
11) Wyse Model 50
12) Xterminal Emulator (xterms)
13) Other

-----
Type the number of your choice and press Return:

```

Figure 3.1: Terminal Type Screen

2. Enter the number for your terminal type and press **Return**. The Specify Host Name screen, shown in Figure 3.2, appears.

NOTE: Cisco Systems recommends a VT100 terminal.

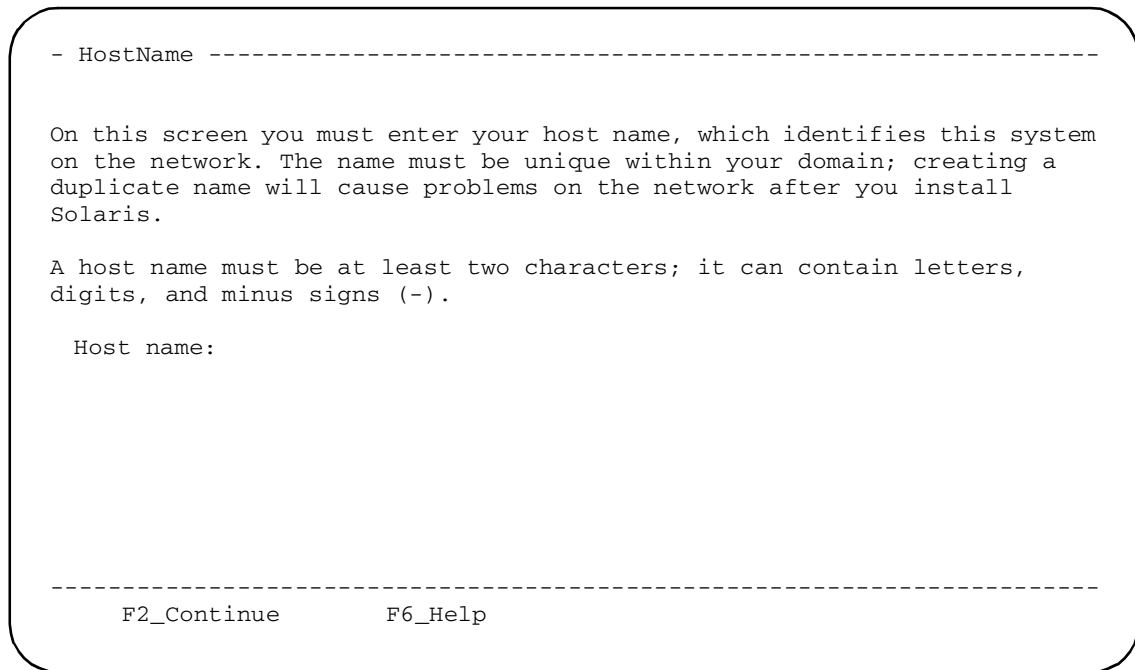

Figure 3.2: Host Name Screen

3. Enter the host name for the Integrated SS7 system, following the instructions on the screen. Press **Return**. The following message appears:

Press F2 to go to the next screen.

Press **F2**. The Network Connectivity screen, shown in Figure 3.3, appears.

```
- Network Connectivity -----  
--  
  
On this screen you must specify whether this system is connected to a  
network. If you specify Yes, the system should be connected to the network  
by an Ethernet or similar network adapter.  
  
>To make a selection, use the arrow keys to highlight the option and  
press Return to mark it [X]  
  
  Networked  
  
  [X] Yes  
  [ ] No  
  
-----  
F2_Continue      F6_Help
```

Figure 3.3: Network Connectivity Screen

4. Position the cursor in the correct field using the arrow keys and press **Return** to mark the field with an **X**.
5. Press Return. If you selected **Yes** in the Network Connectivity Screen, the IP Address screen, shown in Figure 3.4, appears.

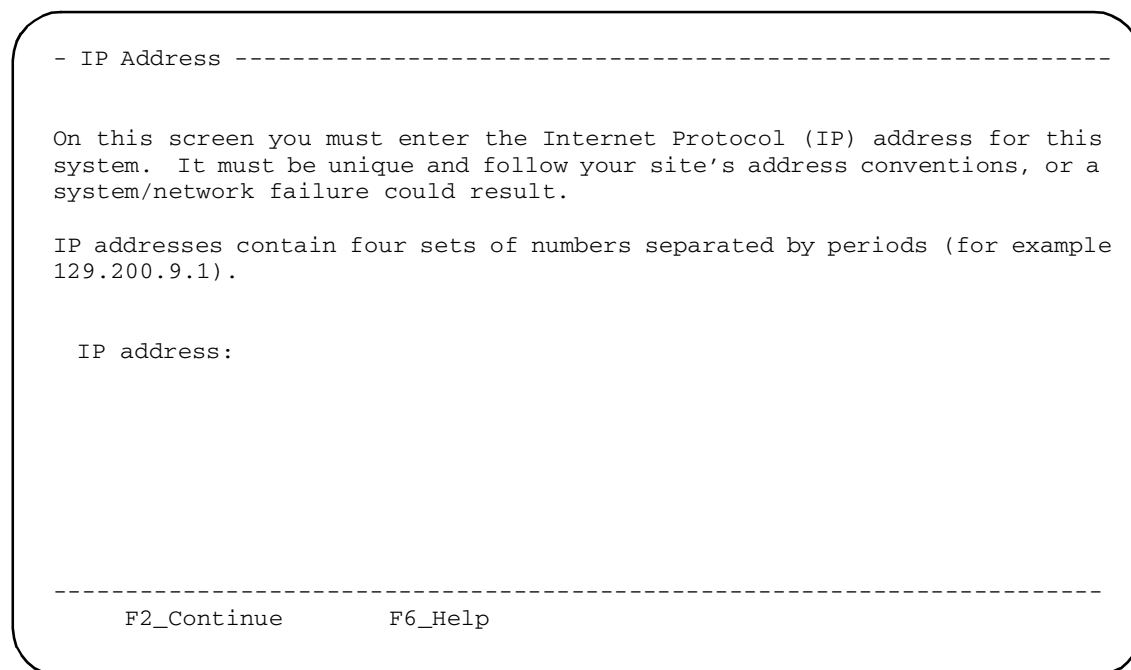

Figure 3.4: IP Address Screen

6. Enter the IP address for the Integrated SS7 system, following the instructions on the screen, and press **Return**.

The Confirm Host, Network, and IP Address screen, shown in Figure 3.5, appears.

```
- Confirm Information -----  
  
Confirm the following information. If it is correct, press F2;  
to change any information, press F4.  
  
Host name:<your host>  
Networked: Yes  
IP address: <host IP address>  
  
-----  
F2_Continue      F4 Change      F6_Help
```

Figure 3.5: Confirm Host, Network, And IP Address Screen

7. The Confirm Host, Network, and IP Address screen displays the hostname, network selection, and IP address you entered on the previous screens.
To accept the displayed information and continue the configuration, press **F2**.
The Name Service screen, shown in Figure 3.6 appears.
To change the hostname, press **F4**. The Host Name screen (Figure 3.2) reappears. Go back to Step 3.

```
- Name Service -----  
  
On this screen you must provide name service information. Select NIS+ or  
NIS if this system is known to the name server; select Other if your site  
is using another name service (for example, DCE or DNS); select None if  
your site is not using a name service, or is not yet established.  
  
> To make a selection, use the arrow keys to highlight the option  
and press Return to mark it [X].  
  
Name Service  
-----  
[ ] NIS+  
[X] NIS (formerly yp)  
[ ] Other  
[ ] None  
  
-----  
F2_Continue      F6_Help
```

Figure 3.6: Name Service Screen

8. Specify the name service for your system:
 - a. Use the up or down arrows to highlight the name service.
 - b. Press **Return**. Your selection is marked with an **X**.
 - c. Press **F2** to continue. The Domain Name screen, shown in Figure 3.7, appears if you enter anything except "None." Otherwise, continue to Step 13.

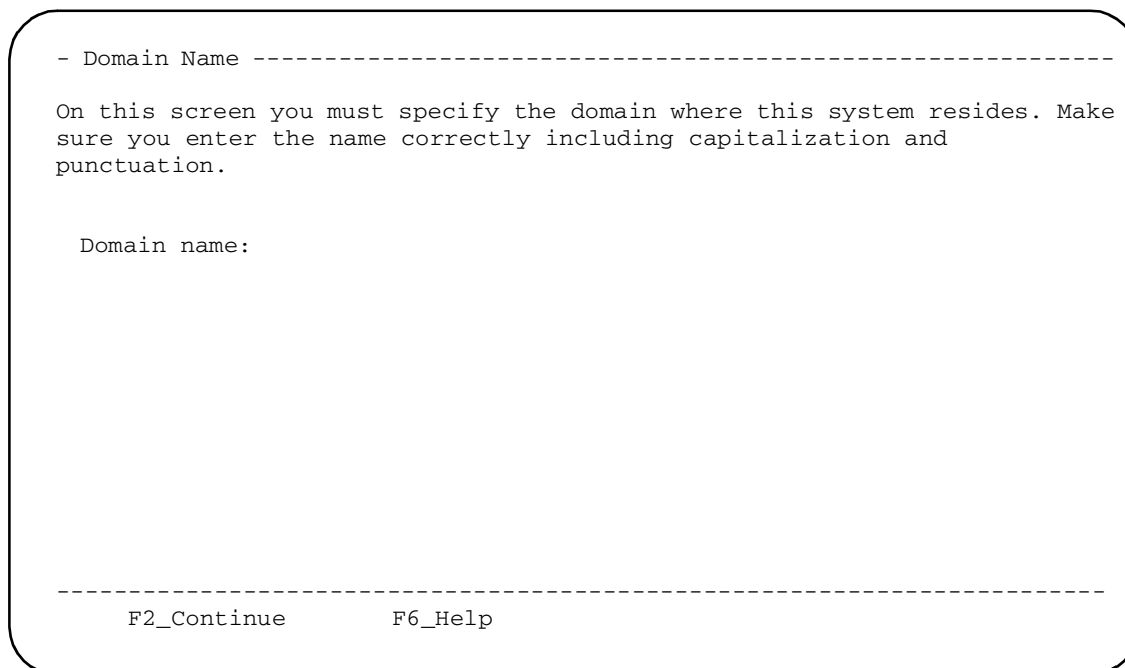

Figure 3.7: Domain Name Screen

9. Enter the domain name in which the Integrated SS7 system resides following the instructions on the screen.

Press **F2** to continue. The Name Server screen, shown in Figure 3.8, appears.

```
- Name Server -----  
  
On this screen you must specify how to find a name server for this system.  
You can let the software try to find one, or you can specify one. The  
software can find a name server only if it is on your local subnet.  
  
> To make a selection, use the arrow keys to highlight the option and  
press Return to mark it [X].  
  
Name Server  
-----  
[X] Find one  
[ ] Specify one  
  
-----  
F2_Continue      F6_Help
```

Figure 3.8: Name Server Screen

10. The Name Server screen allows you to specify a Name Server or allows the system to find one for you.

To let the system find a name server for you:

- a. Press **F2** to continue. The Confirm Host Information screen, shown in Figure 3.10, appears.
- b. Go to Step 12.

To specify a name server:

- c. Use the down arrow to highlight the **Specify one** field.
- d. Press **Return**. The field is marked with an **X**.
- e. Press **F2**. The Specify Name Server Information screen, shown in Figure 3.9, appears.

```
- Name Server Information -----  
-----  
  
On this screen you must enter the host name and IP address of your name  
server. Host names must be at least two characters, and may contain  
letters, digits, and minus signs (-). IP addresses must contain four sets  
of numbers separated by periods (for example 129.200.9.1)  
  
Server's host name:  
Server's IP address:  
  
-----  
F2_Continue      F6_Help
```

Figure 3.9: Specify Name Server Information Screen

11. Specify the Name Server's hostname and IP address and press **F2**. The Confirm Information screen, shown in Figure 3.10, appears.

```
- Confirm Information -----  
-----  
> Confirm the following information. If it is correct, press F2;  
to change any information, press F4.  
  
Name service: NIS  
Domain name: <domain>  
Name server: Find one  
  
-----  
F2_Continue      F4_Change      F6_Help
```

Figure 3.10: Confirm Information Screen

12. The Confirm Information screen displays the host information you entered on the three previous screens.

To accept this information, press **F2**. The Subnet screen, shown in Figure 3.12 appears.

To change any of the host information, press **F4**. The Name Service screen, (Figure 3.6) reappears. Go back to Step 8.

NOTE: If the system determines that you made a mistake entering the host information, an error screen similar to the screen shown in Figure 3.11 appears.

```
- Name Service Error -----  
  
The following error occurred while trying to locate an NIS+ server for  
domain <domain>:  
The NIS+ server that responded is: .  
  
To resolve this problem, run `nisinit -c -B' after the system has booted  
or manually enter new name service information.  
  
Enter new name service information?  
-----  
[X] Yes  
[ ] No  
  
-----  
F2_Continue      F6_Help
```

Figure 3.11: Sample Name Service Error Screen

*If you specify **Yes** on this screen, the Name Service screen, (Figure 3.6) reappears. To correct this information, repeat Step 8 through Step 12.*

```
- Subnets -----  
  
On this screen you must specify whether this system is part of a subnet.  
If you specify incorrectly, the system will have problems communicating on  
the network after you reboot.  
  
> To make a selection, use the arrows keys to highlight the option and  
press Return to mark it [X].  
  
System part of a subnet  
-----  
[X] Yes  
[ ] No  
  
-----  
F2_Continue      F6_Help
```

Figure 3.12: Subnet Screen

13. Specify whether your system is part of a subnet:

- a. Use the up or down arrows to highlight **Yes** or **No**.
- b. Press **Return**. Your selection is marked with an **X**.
- c. Press **F2**.

If you selected **Yes**, the Netmask screen, shown in Figure 3.14, appears and you should go on to Step 15.

If you selected **No**, a Confirm Information screen, as shown in Figure 3.13 appears.

```
- Confirm Information -----  
> Confirm the following information. If it is correct, press F2;  
  to change any information, press F4.  
  
      Name Service : NIS  
System part of subnet : No  
  
-----  
F2_Continue      F4_Change      F6_Help
```

Figure 3.13: Confirm Information Screen

14. The Confirm Information screen displays the information you entered on the two previous screens.

To accept this information, press **F2**. The Netmask screen, shown in Figure 3.14 appears.

To change any of the information, press **F4**. The Subnet screen (See Figure 3.12) reappears. Go back to Step 13.

```
- Netmask -----  
  
On this screen you must specify the netmask of your subnet. A default  
netmask is shown; do not accept the default unless you are sure it is  
correct for your subnet. A netmask must contain four sets of numbers  
separated by periods (for example 255.255.255.0).  
  
Netmask: 255.255.255.0  
  
-----  
F2_Continue      F6_Help
```

Figure 3.14: Netmask Screen

15. Enter the Netmask value and press **F2**. The Default Region screen, shown in Figure 3.15, appears.

```
- Region -----  
  
On this screen you must specify your default region. You can specify a  
time zone in three ways: select one of the geographic regions from the  
list, select other - offset from GMT, or other - specify time zone file.  
  
> To make a selection, use the arrows keys to highlight the option and  
press Return to mark it [X].  
  
Regions  
-----  
[ ] Africa  
[ ] Asia, Eastern  
[ ] Asia, Western  
[ ] Australia / New Zealand  
[ ] Canada  
[ ] Europe  
[ ] Mexico  
[ ] South America  
[ ] United States  
[ ] other - offset from GMT  
[ ] other - specify time zone file  
  
-----  
F2_Continue      F6_Help
```

Figure 3.15: Default Region Screen

16. Specify the default region:

- a. Use the up or down arrows to highlight the region.
- b. Press **Return**. Your selection is marked with an **X**.
- c. Press **F2**. The Default Time Zone screen, similar to the screen shown in Figure 3.16, appears.

```
- Time Zone -----  
  
> To make a selection, use the arrows keys to highlight the option and  
press Return to mark it [X].  
  
Time Zones  
-----  
[REGION SPECIFIC OPTIONS]  
  
-----  
F2_Continue      F6_Help
```

Figure 3.16: Default Time Zone Screen

17. Specify the default time zone:
 - a. Use the up or down arrows to highlight the time zone.
 - b. Press **Return**. Your selection is marked with an **X**.
 - c. Press **F2**. The Default Date and Time screen, similar to the screen shown in Figure 3.17, appears.

```
- Date and Time -----  
  
> Accept the default date and time or enter  
   new values.  
  
   Year (4 digits) :  
     Month (1-12) :  
       Day (1-31) :  
         Hour (0-23) :  
           Minute (1-59) :  
  
-----  
F2_Continue      F6_Help
```

Figure 3.17: Default Date and Time Screen

18. Specify the default date and time:

- a. To accept the default date and time, press **F2**.
- b. To enter new values, use the up or down arrows to highlight the appropriate line and fill in new value.
- c. When finished, press **F2**. The Confirm Time Zone and Date and Time screen, similar to the screen shown in Figure 3.18, appears.

```
- Confirm Information -----  
> Confirm the following information. If it is correct, press F2;  
  to change any information, press F4.  
  
      Time Zone   : Eastern  
      Date and Time :  
  
-----  
      F2_Continue   F4_Change   F6_Help
```

Figure 3.18: Confirm Time Zone and Date and Time Screen

19. The Confirm Time Zone and Date and Time screen displays the host information you entered on the three previous screens.

To accept this information, press **F2**. The Specify Root Password screen, shown in Figure 3.19 appears.

To change any of the information on the Confirm Time Zone and Date and Time screen, press **F4**. The Time Zone screen (See Figure 3.16) appears. Go back to Step 17.

```
On this screen you can create a root password.

A root password can contain any number of characters, but only the first eight
characters in the password are significant. (For example, if you create
`a1b2c3d4e5f6` as your root password, you can use `a1b2c3d4` to gain root
access.)

You will be prompted to type the root password twice; for security, the
password will not be displayed on the screen as you type it.

> If you do not want a root password, press RETURN twice.

Root password:

Press RETURN to continue

Re-enter your password:

Press RETURN to continue.
```

Figure 3.19: Specify Root Password Screen

20. Enter the root password and press **Return**. The system prompts you to confirm your password by retyping it.

NOTE: Cisco Systems recommends that you always enter a root password on this screen.

21. Reenter the password and press **Return**. If you make a mistake, the following message appears:

```
Your password entries do not match. Try again.
Press Return to continue.
```

22. When your root password is entered and confirmed, messages similar to the following appear:

```
System identification is completed.

Setting default interface for multicast: add net ###.###.###: gateway
<your host>
syslog service starting
Print Services started
volume management starting.
Cktint auto-start initialization in progress...This may take awhile.
Initialization n% completed.
done
The system is ready.
<host name> console login:
```

*NOTE: If any of the sys-config information is incorrect, the boot messages after the "System identification completed" message does not appear. If this occurs, press **CTRL-D** to reboot the system. When the system is ready, run **sys-unconfig** as described in Section 3.1.2 and reboot.*

23. Reboot the Integrated SS7 system by typing **boot** and pressing **Return**.
24. If you have a redundant configuration, return to Step 1 and run the installation script from the console on side B.

The Integrated SS7 system is now configured for two users: **root** and **cktint**.

3.4 MODIFYING THE INTEGRATED SS7 /ETC/HOSTS FILE

In order for the Integrated SS7 system to run on the network, it must have a hostname and an IP address defined in its **/etc/hosts** file. This information is used by the network to locate and identify the Integrated SS7 system.

The **/etc/hosts** file is located in the system's root file system. When you ran **sys_config**, the script wrote the Integrated SS7 system hostname and IP address into the **/etc/hosts** file for you. *You must modify the file to include the hostname and IP address of the VCO/4K to this file.*

*If you have a redundant configuration, you must modify the file to include the Integrated SS7 system hostname and IP address **and** the hostname and IP address of the VCO/4K on the other side. Figure 3.20 is an illustrated example of the **/etc/hosts** file for a redundant configuration with two host systems.*

Block Diagram Of Redundant Configuration

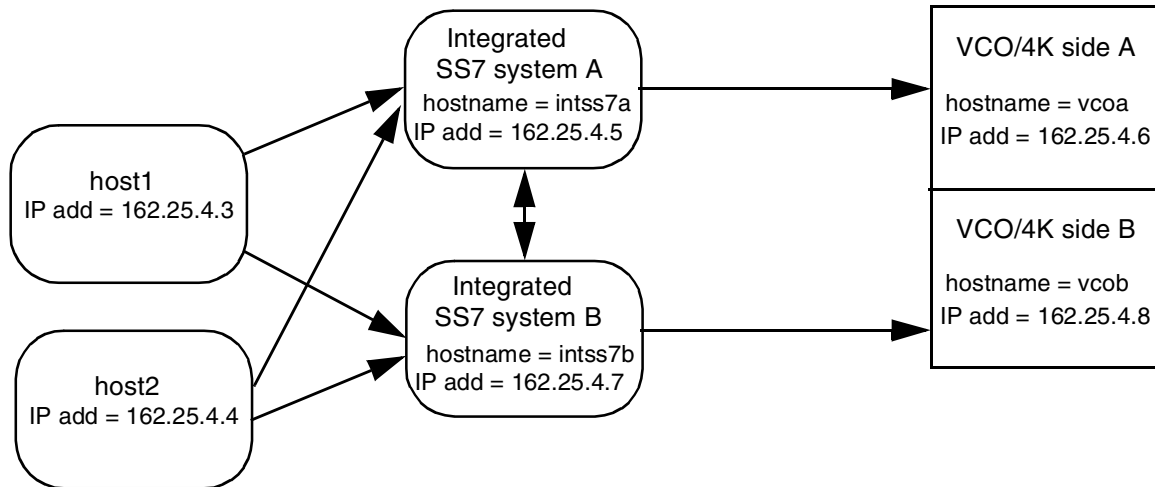

Contents of /etc/hosts files

Integrated SS7 system side A

```

127.0.0.1    localhost *
162.24.4.7  intss7b
162.24.4.5  intss7a
162.25.4.8  vcoB**
162.25.4.6  vcoA
162.25.4.3  host1
162.25.4.4  host2
  
```

Integrated SS7 system side B

```

127.0.0.1    localhost *
162.24.4.5  intss7a
162.24.4.7  intss7b
162.25.4.6  vcoA**
162.25.4.8  vcoB
162.25.4.3  host1
162.25.4.4  host2
  
```

* The localhost entry appears in all /etc/hosts files and is for use by the network for local loop-back functions. Integrated SS7 users can ignore this entry.

** Even though the SS7 system never communicates with the VCO/4K on its redundant side, Cisco Systems recommends that you include the hostname and IP addresses for Telnet purposes.

Figure 3.20: /etc/hosts Files in a Redundant Configuration

NOTE: In a redundant configuration, the host name for both Integrated SS7 systems must be the same except for the last character. The last character for side A must be "a." The last character for side B must be "b."

3.4.1 Modifying The /etc/hosts File For Non-Redundant Configurations

To modify the **/etc/hosts** file for a non-redundant system, complete the following steps:

1. From the Integrated SS7 system console, log in as **root**.

*NOTE: The initial password is factory-configured as “**abc123**” for **root** and **cktint**. However, the password may have been changed when the Circuit Interworking software was installed. If you do not know **root**'s password, contact your network administrator.*

2. Enter **cd** to **/etc**.
3. Open the **hosts** file for editing with a UNIX text editor, such as **vi**.
4. Add the hostnames and the IP addresses for the VCO/4K and host(s). Refer to your Network Information Worksheet for this information.
5. Save and close the file.

NOTE: You do not have to reboot the system for these changes to take affect.

3.4.2 Modifying The /etc/hosts File For Redundant Configurations

To modify the **/etc/hosts** file for a redundant system, complete the following steps:

1. From the Integrated SS7 system console on side A, log in as **root**.

*NOTE: The initial password is factory-configured as “**abc123**” for **root** and **cktint**. However, the password may have been changed when the Circuit Interworking software was installed. If you do not know **root**'s password, contact your network administrator.*

2. Enter **cd** to **/etc**.
3. Open the **hosts** file for editing with a UNIX text editor, such as **vi**.
4. Add the hostnames and the IP addresses for the side A VCO/4K, host(s), and the Integrated SS7 installed in side B (See Figure 3.20).
5. Save and close the file.
6. From the Integrated SS7 system console on side B, log in as **root** and repeat Step 2 and Step 3.
7. Add the hostnames and the IP addresses for the side B VCO/4K, host(s), and the Integrated SS7 in side A (See Figure 3.20).
8. Save and close the file.

NOTE: You do not have to reboot the system for these changes to take affect.

3.5 TESTING THE INSTALLATION

This section describes how to test the installation by using the UNIX **ping** command. Refer to your Network Information Worksheet for the correct hostnames for these procedures.

3.5.1 Testing Non-Redundant Configurations

To verify that the network connections and **/etc/hosts** entries are correct, complete the following steps:

1. Verify that all systems are up and running and that **root** is still logged into the Integrated SS7 system.
2. From the Integrated SS7 system console, use the **ping** command as follows:

```
ping <hostname>
```

where <hostname> is the name you assigned to the VCO/4K.

If the connections and **/etc/hosts** entries are correct, the system responds to the ping command with the following message:

```
<hostname> is alive
```

NOTE: If there is a problem, the system responds with one of the following error messages:

```
no answer from <hostname>
```

or

```
unknown host <hostname>
```

*If either of these messages appear, verify that the hostnames and the IP addresses in the **/etc/hosts** file are correct. If these are correct, verify the network connections. If you have any questions, contact Cisco Systems Technical Support.*

3.5.2 Testing Redundant Configurations

1. Go to the Integrated SS7 system console on side A and, if necessary, log in as **root**.
2. Ping the side A VCO/4K using the following command:

```
ping <hostname>
```

where <hostname> is the name you assigned to the side A VCO/4K.

If the connections and /etc/hosts entries are correct, the system responds with the following message:

```
<hostname> is alive
```

3. Ping side B Integrated SS7 installed in side B.
4. Go to the Integrated SS7 system console on side B.
5. Ping the side B VCO/4K.
6. Ping the side A Integrated SS7 system.

NOTE: If there is a problem, the system responds with one of the following error messages:

```
no answer from <hostname>
```

or

```
unknown host <hostname>
```

*If either of these messages appear, verify that the hostnames and the IP addresses in the **/etc/hosts** file are correct. If these are correct, verify the network connections. If you have any questions, contact Cisco Systems Technical Support.*

Section 4

INTEGRATED SS7 CONFIGURATION

4.1 INTRODUCTION

This section describes how to configure the following Integrated SS7 system components:

- SS7 layers (Message Transfer Part (MTP) and TUP)
- Circuit Interworking (CktInt)
- Resource provisioning files
- Redundancy
- 2k to 4k and 4k to 2k Configurator

The Integrated SS7 software includes several default configuration files which you can modify to suite the needs of your installation. The SS7 layer configuration files are .mml files. The CktInt and resource provisioning files are text files, which you modify with any standard UNIX text editor. You can also display and modify these files with the Configuration Tool.

4.2 CONFIGURATION WORKSHEETS

Before you begin the configuration, make copies of the appropriate Site Configuration and Circuit Configuration worksheets, which follow, and fill them out with the assistance of your network administrator. You also need the Network Information worksheets from *Section 3*.

If you have any questions regarding the configuration worksheets, contact Cisco Systems Technical Support for assistance.

Site Configuration Worksheet TUP Only - STP

SS7 Links
E1/T1 Trunks ———

Route Set Name: _____
DPC: ____ - ____ - ____

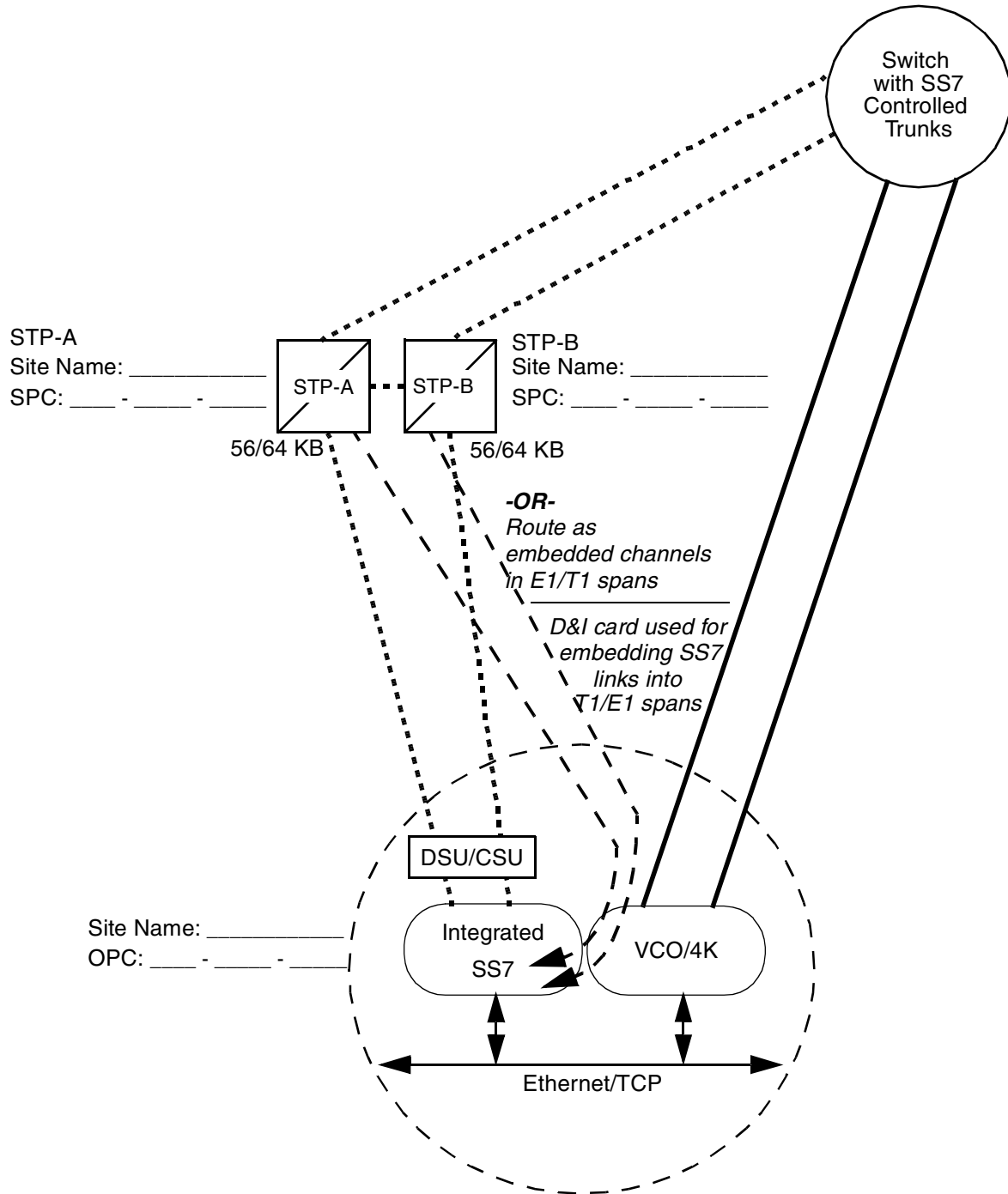

Site Configuration Worksheet TUP Only - No STP

SS7 Links
E1/T1 Trunks _____

Site Name: _____
DPC: ____ - ____ - ____

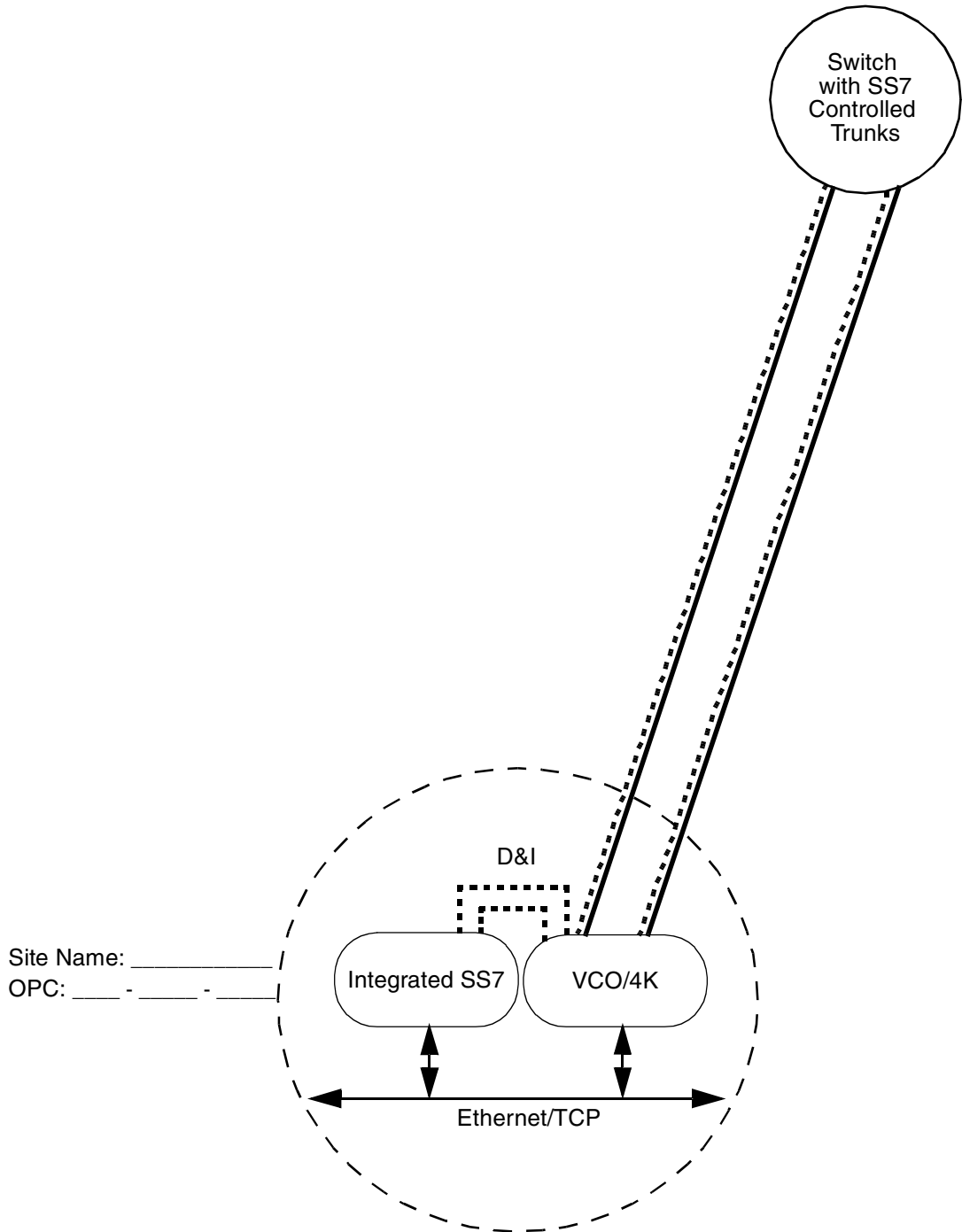

Circuit Configuration Worksheet

VCO/4K Port Addr.	Circuit ID (CCTNUM)	Circuit Name	Circuit Group (GRPID)	Trunk ID (TRNKGRPID)	Resource Group	Rack	Level	Slot

4.3 SS7 LAYERS CONFIGURATION

The configuration files for the SS7 layers are .mml files. They are Man-Machine Language (MML) commands described in the *NewNet Access Manual*. This subsection contains an example configuration file and instructions for creating and loading the configuration file for your site. This subsection is divided into three parts:

- *Section 4.3.1* describes how to use the MML HELP command.
- *Section 4.3.2* contains examples of the configuration files and describes the MML commands used to create them. (For a complete listing of all MML commands and more examples, refer to the *NewNet Access Manual*.)
- *Section 4.3.3* describes how to create/modify and load the configuration file on the Integrated SS7 system.

Example configuration files are located in `~/sys/SPcc ($SPC)`. Use the examples in *Section 4.3.2* and the example files in `~/sys/SPcc` as a guide for creating the configuration file for your site.

NOTE: Lines in the configuration files must be ordered as shown in these examples.

Place your custom .mml files in `~/sys/SPcc ($SPC)`.

4.3.1 MML HELP Command

The HELP command allows you to view on-line documentation for any command while you are running MML. To view the on-line documentation, complete the following steps:

1. If you are not running MML, enter the following command and press **Return**:

```
mml 0
```

The **MML>** prompt appears.

2. At the **MML>** prompt, enter the following command and press **Return**:

```
HELP;;
```

A listing of all the MML commands appears. At the end of the listing, a new prompt, **MML_HELP>**, also appears.

3. At the **MML_HELP>** prompt, enter the command, exactly as it appears in the listing, followed by a colon (:) and semicolon (;), and press **Return**.

The on-line documentation for the command appears.

Once you have reached the end of the on-line documentation file, the system automatically exits HELP and the **MML>** appears.

4. To view the on-line documentation for additional commands, repeat Step 2 and Step 3.

4.3.2 Site Configuration Example

There are two files for configuring the SS7 layers required to run TUP:

- Message Transfer Part (MTP) configuration file, which has two distinct parts:
 - MTP Level 2 Provisioning, which configures the Integrated SS7 signaling points and link sets.
 - MTP Level 3 Provisioning, which configures the route sets.
- TUP Provisioning—configures the T1 (or E1) circuits.

The MTP and TUP configuration files are used by the system for TUP applications.

Figure 4.1 is an illustrated example of a site configuration.

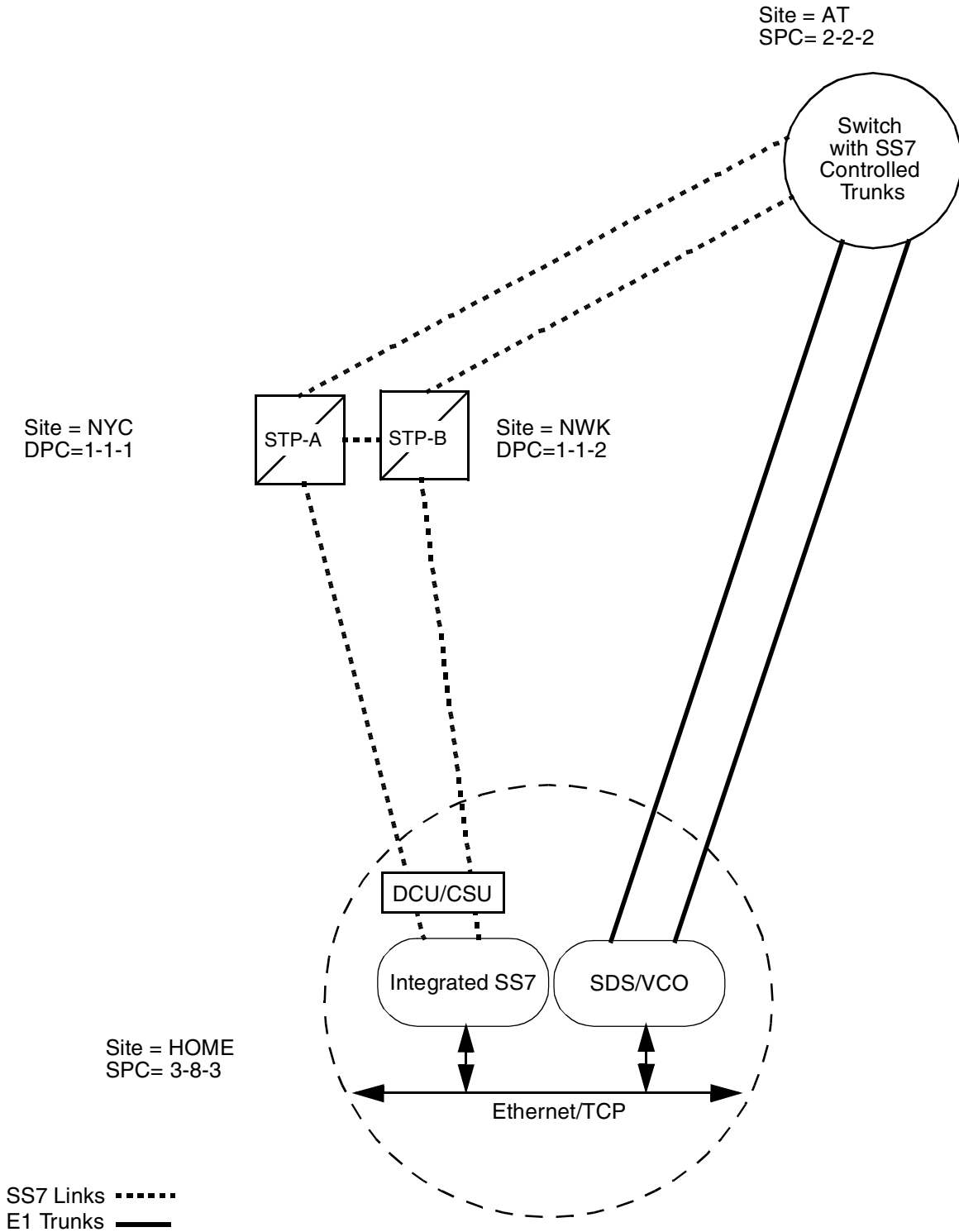
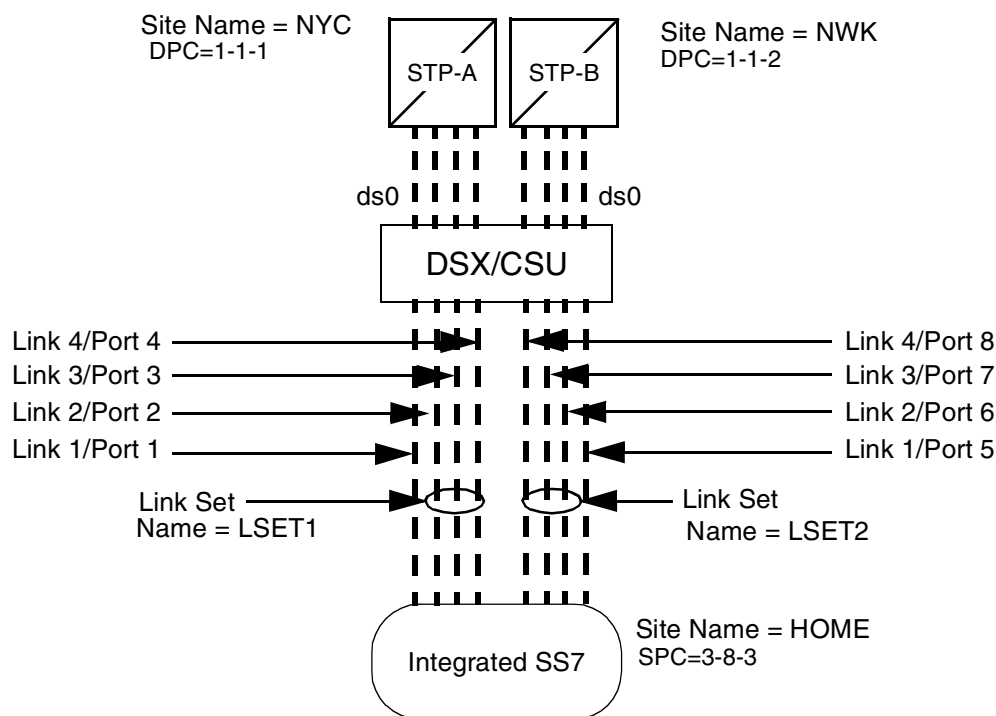

Figure 4.1: Site Configuration Example

4.3.2.1 MTP Level 2 Provisioning Part

The MTP Level 2 Provisioning part of the MTP configuration file defines the network indicator and signaling point code used by the Integrated SS7, and defines the Integrated SS7 links and link sets. Figure 4.2 is an MTP Level 2 provisioning example.



Lines in **<filename>**, where filename is recommended to be called **mtp.mml** (or any name that includes mtp and has the extension .mml) for MTP Level 2 Provisioning.

- (1) MML-CONFIG:LOG=ON,TIMEOUT=6000;
- (2) MODIFY-SP:NAME=HOME,SPC=3-8-3,NI=NATIONAL,TYPE=SEP,RESTART=OFF,SLTC=REGULAR;
- (3) ADD-LSET:LSET=LSET1,DPC=1-1-1,LOADED=4,ACTIVE=4,TYPE=ALINK,BR=64000;
- (4) ADD-LSET:LSET=LSET2,DPC=1-1-2,LOADED=4,ACTIVE=4,TYPE=ALINK,BR=64000;
- (5) ADD-LINK:LINK=LINK1,LSET=LSET1,SLC=0,PORT=1,TYPE=DTE,PRIORITY=0;
- (6) ADD-LINK:LINK=LINK2,LSET=LSET1,SLC=1,PORT=2,TYPE=DTE,PRIORITY=1;
- (7) ADD-LINK:LINK=LINK3,LSET=LSET1,SLC=2,PORT=3,TYPE=DTE,PRIORITY=2;
- (8) ADD-LINK:LINK=LINK4,LSET=LSET1,SLC=3,PORT=4,TYPE=DTE,PRIORITY=3;
- (9) ADD-LINK:LINK=LINK1,LSET=LSET2,SLC=0,PORT=5,TYPE=DTE,PRIORITY=0;
- (10) ADD-LINK:LINK=LINK2,LSET=LSET2,SLC=1,PORT=6,TYPE=DTE,PRIORITY=1;
- (11) ADD-LINK:LINK=LINK3,LSET=LSET2,SLC=2,PORT=7,TYPE=DTE,PRIORITY=2;
- (12) ADD-LINK:LINK=LINK4,LSET=LSET2,SLC=3,PORT=8,TYPE=DTE,PRIORITY=3;

Figure 4.2: MTP Level 2 Provisioning Example

The **MML-CONFIG** command (line 1 of the example .mml file in Figure 4.2) turns on the command logging function. This function logs all MML commands into the file **\$EBSHOME/access/RUN<SP#>/backup/MMLcmds.current**. The following are the parameters for MML-CONFIG:

LOG—Valid values are ON and OFF.

TIMEOUT—Specifies how long (in milliseconds) MML waits for an answer before timing out and displaying an SPM time out error message. Valid values for this parameter are 0 to 65000 milliseconds.

NOTE: Cisco Systems recommends you set the value to 6000 milliseconds.

The **MODIFY-SP** command (line 2) specifies the configuration for the Integrated SS7 system and sets the SPC Restart State indicator and Signaling-Link Test-Control state indicator. The following are the parameters for MODIFY-SP:

NAME—The name of your site. Valid values are alphanumeric. Valid lengths are one to 11 characters.

SPC—The signaling point code (SPC) defined by the SS7 network administrator.

NI—The network indicator. Valid values for NI are:

INTERNATIONAL	00
SPARE (International Only)	01
NATIONAL	02
RESERVED (National Only)	03

TYPE—Specifies whether the Integrated SS7 is a signaling transfer point (STP) or signaling end point (SEP).

NOTE: Integrated SS7 only supports SEP.

RESTART—Sets the SPC Restart State indicator. Valid values are ON and OFF.

SLTC—Sets the Signaling-Link Test-Control State indicator. Valid values are REGULAR, SPECIAL, and OFF. Default is REGULAR.

NOTE: When modifying the signaling point code (line 2 of example), the RESTART parameter is automatically initialized as OFF. A second MODIFY-SP command must be entered to set the RESTART parameter to ON after initialization is complete.

The **ADD-LSET** command (lines 3 and 4) defines the link sets from the Integrated SS7. A link set is a set of one or more links going to the same destination point code (DPC). The example in Figure 4.2 has two-link sets with four links in each set.

The following are the parameters for ADD-LSET:

LSET—A user defined name that identifies the link set. Valid values are alphanumeric. Valid lengths are 1 to 8 characters.

DPC—The DPC of the STP the link set to which the link set is connecting. Get the DPC from the SS7 network administrator.

LOADED—Defines how many links are configured in the link set (i.e., number of links from each STP). Valid values for Integrated SS7 configurations with four-link Sbus cards are 0 through 4. Valid values for Integrated SS7 configurations with eight-link Sbus cards are 0 through 8.

ACTIVE—Defines how many *active* links there are in the link set, that is, how many links will be carrying messages. Valid values for Integrated SS7 configurations with four-link Sbus cards are 0 through 4. Valid values for Integrated SS7 configurations with eight-link Sbus cards are 0 through 8.

NOTE: The NewNet Access Manual states that valid values for LOADED and ACTIVE are 0 to 15. However, Integrated SS7 systems configured with 4-link Sbus cards support a maximum of four links. Therefore, values greater than 4 are invalid. In the same way, Integrated SS7 systems configured with 8-link Sbus cards support a maximum of eight links. Therefore, values greater than 8 are invalid.

TYPE—Specifies the type of link set. The following are the valid values for TYPE:

Numeric Value	Alias	Meaning
0	ALINK	Access link
5	FLINK	Link between two SEPs

*NOTE: The NewNet AccessManager manual states that 1 (BLINK), 2 (CLINK), 3 (DLINK), and 4 (ELINK) are also valid values for TYPE, but **Integrated SS7 only supports 0 (ALINK) and 5 (FLINK).***

BR—Specifies the baud rate for this link set. The following are the valid values for BR:

4800 bps
 7200 bps
 9600 bps
 19200 bps
 38400 bps
 56000 bps
 64000 bps

The **ADD-LINK** command (lines 5 through 12) defines the links that belong in each link set. The links in lines 5 to 8 belong to the link set you defined in line 3. The links in lines 9 to 12 belong to the link set you defined in line 4.

The following are the parameters for ADD-LINK:

LINK—A user-defined value that identifies the link. Valid values are alphanumeric. Valid lengths are 1 to 11 characters.

LSET—The name of the link set to which you are adding the link.

SLC—The signaling link code (SLC). SLC is a numerical value of 0 to 15. These values must be unique within each link set. You must start numbering at 0 and number each additional sequentially.

PORT—The logical port number for the ports on the Sbus card. The valid values for PORT are:

- 1 to 4 for 4-link configurations
- 1 to 4 and 5 to 8 for 8-link configurations

NOTE: The system uses ecpt file(s) to determine port numbers. Ports always begin at 1.

TYPE—This value is always DTE.

*NOTE: The NewNet AccessManager manual states that TYPE can be either DTE or DCE, but **Integrated SS7 only supports DTE.***

PRIORITY—The priority of the signaling link. Valid values are 0 to 15, where 0 is the highest priority and 15 is the lowest priority.

4.3.2.2 MTP Level 3 Provisioning

The MTP Level 3 Provisioning part of the MTP configuration file defines the routes. Figure 4.3 is an example of this part.

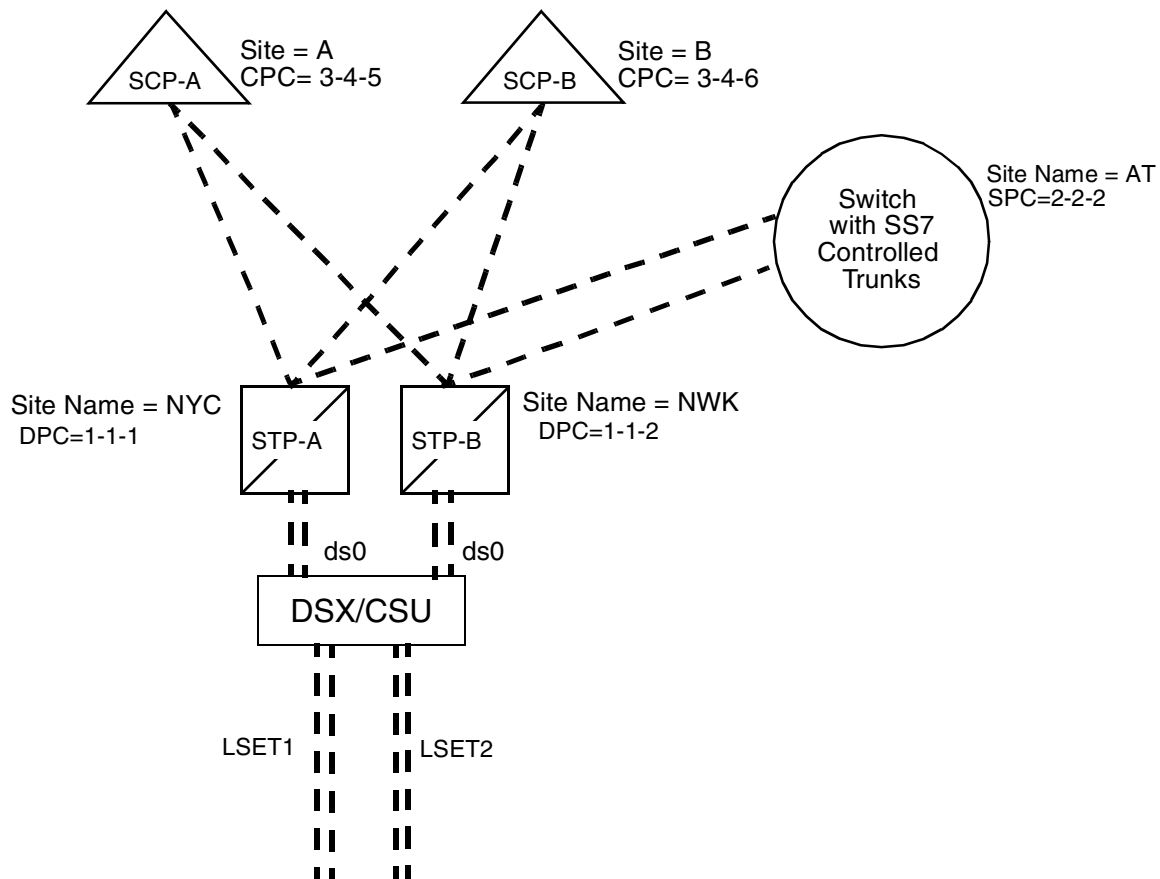

Lines in <filename> for MTP 3 Level Provisioning.

- (13) ADD-RTSET:RTSET=AT,DPC=2-2-2,ROUTE1=LSET1,ROUTE2=LSET2;
- (14) ADD-ROUTE:RTSET=LSET2STP,LSET=LSET1,PRIORITY=1;
- (15) ADD-ROUTE:RTSET=LSET1STP,LSET=LSET2,PRIORITY=1;
- (16) MODIFY-LSET:LSET=LSET1,ADMINSTATE=ACTIVE;
- (17) MODIFY-LSET:LSET=LSET2,ADMINSTATE=ACTIVE;
- (18) MODIFY-ALARM-CONFIG:DISPLAY=OFF;
- (19) EXIT;;

Figure 4.3: MTP Level 3 Provisioning Example

The **ADD-RTSET** command in line 13 of Figure 4.3 adds a new route set to the network. The following are the parameters for ADD-RTSET:

RTSET—A user-defined name that identifies the route set. Valid values are alphanumeric. Valid lengths are one to 11 characters.

DPC—The destination point code for this route set.

ROUTE1 and **ROUTE2**—Specifies the link sets in this route set. Note that the link sets should be listed in priority order.

NOTE: A default route set is automatically created by the system for each link set defined in MTP Level 2 Provisioning. The system creates the default route set name by appending the link set name with either STP (signaling transfer point) or SEP (signaling end point). In this example, the default route set names are LSET1STP and LSET2STP.

The **ADD-ROUTE** commands in lines 14 and 15 of Figure 4.3 add the default route sets for the link sets defined in the MTP 2 Level Provisioning part. The default route sets must always be added to the MTP 3 Level Provisioning part of the configuration file.

The following are the parameters for ADD-ROUTE:

RTSET—The name of the default route set for the link set. You defined the link sets in MTP2 Provisioning, lines 3 and 4 in Figure 4.2. The system created the name for the default route set (RTSET) by appending the link set name with either STP or SEP. For example, in Figure 4.2, the link sets are LSET1 and LSET2. Therefore, the default route set names (RSET) are LSET1STP and LSET2STP respectively.

LSET—The name of the link sets you defined in MTP2 Provisioning (lines 3 and 4 in Figure 4.2).

PRIORITY—The priority of the link set. Valid values for PRIORITY when specified in the RTSET command are 0 through 3, where 0 is the highest priority and 3 is the lowest.

The default route sets have their associated link sets as the first priority route (0). Therefore, any routes you add to the configuration must start with priority = 1.

The **MODIFY-LSET** commands in lines 16 and 17 sets the link sets to active. The following are the parameters for MODIFY-LSET:

LSET—A user defined value that identifies the link set. Valid values are alphanumeric. Valid lengths are 1 to 8 characters.

ADMINSTATE—Sets the administrative state of the link set. Valid values are ACTIVE (activate link set) or INACTIVE (deactivate link set).

The **MODIFY-ALARM-CONFIG** command in line 18 allows the user to display alarm messages on the console. The following are the parameters for MODIFY-ALARM-CONFIG:

DISPLAY—Enables or disables the displaying of alarm messages. Valid values are ON and OFF.

Line 19 exits the MML program.

4.3.2.3 TUP Level Provisioning Configuration File

The TUP Level Provisioning configuration file defines the circuits. Figure 4.4 is a TUP provisioning example for a system with Single Span E1 cards.

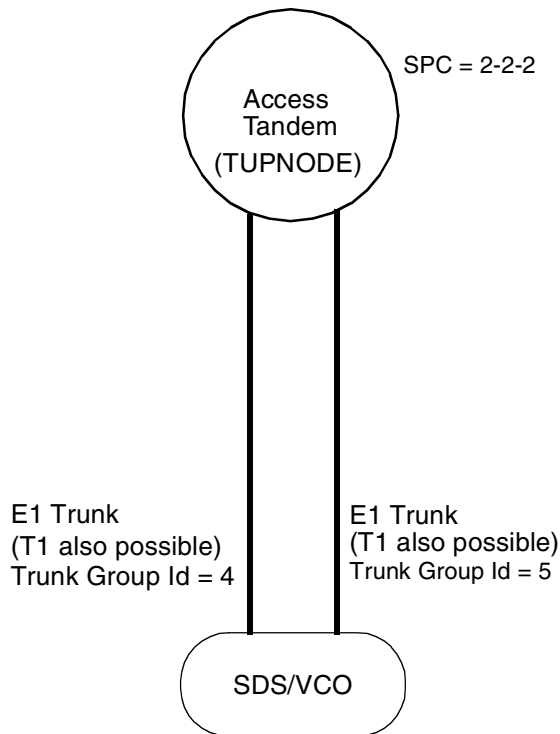

Lines in **<filename>**, where filename is recommended to be called **tup.mml** (or any name that includes tup and has the extension .mml) for TUP Provisioning

- (1) MODIFY-TUPCONF:CFGNAME=CF0,VARIANT=CHINA,SPCTYPE=SPC24BIT;
- (2) ADD-TUPNODE:PCNO=1,DPC=2-2-2;
- (3) ADD-TUPCGRP:PCNO=1,GRPID=1,CCTNUM=32,TRNKGRPID=4;
- (4) ADD-TUPCCT:PCNO=1,GRPID=1,CCTNUM=0,RANGE=32;
- (5) ADD-TUPCGRP:PCNO=1,GRPID=1,CCTNUM=32,TRNKGRPID=5;
- (6) ADD-TUPCCT:PCNO=1,GRPID=2,CCTNUM=0,RANGE=32;
- (7) DISPLAY-TUPNODE:PCNO=1;
- (8) DISPLAY-TUPCGRP:PCNO=1,GRPID=*;
- (9) DISPLAY-TUPCCT:PCNO=1,GRPID=1,CCTNUM=*;
- (10) DISPLAY-TUPCCT:PCNO=1,GRPID=2,CCTNUM=*;
- (11) EXIT;;

Figure 4.4: TUP Level Provisioning Example

The **MODIFY-TUPCONF** command in line 1 of Figure 4.4 modifies the current TUP configuration. The following are parameters for MODIFY-TUPCONF:

CFGNAME—Specifies the TUP configuration name. The system names TUP configuration file using the convention **CF<sp>**, where sp is the signaling point number of the logical node.

VARIANT—Specifies the country variant. For China, this value is CHINA.

SPCTYPE—Sets the signaling point code type. For China, this value is SPC24BIT.

NOTE: Ignore any “No Information to process” errors received for this configuration line; if you see this error, your default is set to China.

The **ADD-TUPNODE** command in line 2 adds a signaling node to the TUP database. The following are the parameters for ADD-TUPNODE:

PCNO—A unique point code index number that refers to the node's destination point code.

DPC—The destination point code for the signaling node.

The **ADD-TUPCGRP** command (lines 3 and 5) adds Circuit Groups to the TUP database. The following are the parameters for ADD-TUPCGRP:

PCNO—A unique point code index number that refers to the DPC.

GRPID—A value that identifies a circuit group. Most often, circuit groups are set up to correspond to a span of an E1/T1 card.

GRPID is a user-defined value you use as a multiplier when you calculate the circuit identification codes (CICs). GRPIDs, along with the DPC, identify specific circuits to the SS7 network. **Valid values are decimal, 0 through 127. Each GRPID must be unique per PCNO.**

TIP: The circuit identification code (CIC) is a decimal number that identifies each circuit to the SS7 network. Calculate the CIC by using the following expression:

$$\text{CIC} = (\text{GRPID} \times 32) + \text{Circuit ID (valid values are 0 to 31)}$$

Since GRPID can equal 0 through 127 and China Circuit IDs can equal 0 to 31, China CICs can equal 1 through 4,095.

$$\text{Max_CIC} = (127 \times 32) + 31 = 4,095$$

CICs are not unique and can be duplicated for different signaling nodes (PCNO).

CCTNUM—Specifies both maximum number of circuits and limits the circuit numbers available to this group (see TUPCCT example on next page). Values are from 1 to 32.

NOTE: Cisco Systems recommends you set the default value to 32.

TRNKGRPID—A unique value that identifies a circuit group. Most often, circuit groups are set up to correspond to a span of an E1/T1 card.

TRNKGRPID is a unique, user-defined value you use as a multiplier when you calculate the global circuit identification codes (GCICs). TRNKGRPIDs identify specific circuits to Circuit Interworking. **Valid values are decimal, 1 through 75 in 2K Mode; 1 through 171 in 4K Mode.**

NOTE: You cannot share trunk group circuits between SPs.

TIP: The global circuit identification code (GCIC) uniquely identifies every circuit in the Integrated SS7 domain. GCICs use the Trunk ID (TRNKGRPID) as a multiplier in the calculation. Calculate GCICs using the following expression:

$$\text{GCIC} = (\text{TRNKGRPID} \times 32) + \text{Circuit ID}$$

Lines 4 and 6 add the individual circuits to each TUP circuit group through **ADD-TUPCCT**. The following are the parameters for this command:

PCNO—A unique point code index number that refers to the DPC for the TUP signaling node.

GRPID—Specifies the ID of the circuit group for this set of circuits. This is the same GRPID as GRPID in lines 3 and 5.

CCTNUM—Specifies the first circuit number in this group, from 0 to 31. **Do not confuse this parameter with CCTNUM in lines 3 and 5.**

RANGE—Specifies the range of sequential numbers used to identify the circuits. Valid values are 1 through 32.

*NOTE: CCTNUM plus RANGE **cannot** exceed the previously set ADD-TUPCGRP CCTNUM value.*

For example, a CCTNUM of 0 and a RANGE of 32 creates 32 circuits, numbered 0 through 31 (CCTNUM + RANGE = 32, therefore, the previous ADD-TUPCGROUP CCTNUM would have to be at least 32). Likewise, a CCTNUM of 10 and a RANGE of 16 creates 16 circuits, numbered 10 through 25 (CCTNUM + RANGE = 26, therefore, the previous ADD-TUPCGROUP CCTNUM would have to be at least 26).

Lines 7 to 10 of the example define the TUP reports to DISPLAY:

- Line 7 sets up the TUP node report for display.
- Line 8 sets up the circuit group report for display.
- Lines 9 and 10 set up the report for circuit groups 1 and 2 for display.

Line 11 exits the MML program.

Refer to the TUP Configuration section in the *NewNet AccessManager Manual* for descriptions and examples of these reports.

4.3.3 Creating/Modifying and Loading the Configuration Files for TUP

This subsection describes how to create or modify the MTP and TUP configuration files, and how to load them to run TUP applications. This procedure only needs to be run once.

To create or modify the configuration files, complete the following steps:

1. If you haven't already done so, log in to the Integrated SS7 system as **cktint**.
2. Use a standard UNIX editor to create the MTP configuration files for your site.

NOTE: Lines in each configuration file must be ordered as shown in this subsection.

3. If the EBS stack is running, enter the following command and press **Return**:

```
stop-ss7.sh
```

Type **px** and press **Return** to verify no processes are running.

4. Enter **rmdb 0** and press **Return**. This deletes all of the files for SP 0 in the EBS database.

NOTE: If you wish to save the existing configuration files, you should copy these files to another location instead of deleting them.

*NOTE: To modify an SP at a later date, you must first run an **rmdb 0** command again to clear the SP's files in the EBS database.*

5. Enter the following command and press **Return**:

```
ebs_start
```

6. **cd** to **~/sys/SPcc**.

7. Enter the following command and press **Return**:

```
upmd 0 &
```

8. Enter the following command and press **Return**:

```
snmd 0 &
```

9. Configure MTP Level 2/3.

Take the .mml file of commands in a single statement:

```
mml 0 <filename>
```

where **filename** is what you created in MTP Level 2/3 Provisioning (See *Section 4.3.2.1* and *Section 4.3.2.2*).

If you use the single command line method, make sure that the MTP level configuration file does not contain blank or comment lines and ends with EXIT;;

As an alternative, you can cut and paste the MTP-related command lines from your MTP configuration file, one-by-one, to the command line of the MML program. Refer to Figure 4.2 and Figure 4.3 for examples of MTP-related commands.

NOTE: Cisco Systems recommends the single command line method.

10. You will receive a <SUCCESS> message for each correct line/command in the .mml file. If everything is correct, go on to Step 11.

If you receive an <ERROR> message, count down to which line the message represents and investigate/edit the original file. Make changes to correct the problem (i.e. typos, etc.), then stop the EBS stack by entering the following command and pressing **Return**:

```
stop-ss7.sh
```

Type **px** and press **Return** to verify no processes are running.

Restart at Step 5.

11. Enter the following command and press **Return**.

```
AccessTUP 0 &
```

12. Configure TUP Level.

Take the .mml file of commands in a single statement:

```
mml 0 <filename>
```

where **filename** is what you created in TUP Level Provisioning (See *Section 4.3.2.3*).

If you use the single command line method, make sure that the TUP configuration file does not contain blank or comment lines and ends with EXIT;;

As an alternative, you can cut and paste the TUP-related command lines, one-by-one, to the command line of the MML program. Refer to Figure 4.4 for examples of TUP-related commands.

NOTE: Cisco Systems recommends the single command line method.

13. You will receive a <SUCCESS> message for each correct line/command in the .mml file. If everything is correct, go on to Step 14.

If you receive an <ERROR> message, count down to which line the message represents and investigate/edit the original file. Make changes to correct the problem (i.e. typos, etc.), then stop the EBS stack by entering the following command and pressing **Return**:

```
stop-ss7.sh
```

Type **px** and press **Return** to verify no processes are running.

Restart at Step 5.

14. Stop the EBS stack by entering the following command and pressing **Return**:

```
stop-ss7.sh
```

Type **px** and press **Return** to verify no processes are running.

15. Restart EBS and load the new configuration file by entering the following command and pressing **Return**:

```
start-ss7.sh
```

Type **px** and press **Return** to verify no processes are running.

*NOTE: **Do not** start CktInt until you configure as shown in Section 4.4.1.*

4.4 PLATFORM CONFIGURATION AND RESOURCE PROVISIONING

This subsection describes how to create the platform configuration and resource provisioning files.

4.4.1 Cktint Configuration File: CktInt.cfg

The cktint configuration file specifies the data necessary for the Circuit Interworking software to interface with the VCO/4K system and the host computer. You can modify the default configuration file, **CktInt.cfg**, to suit your requirements. **CktInt.cfg** resides in directory **~/sys/CktintAnEnv (\$XNV)**.

Figure 4.5 is a sample of the **CktInt.cfg** file for a redundant configuration with four hosts.

```
*-HOST_LINK01:host-1.6050
  -HOST_LINK02:host-2.6060
  -HOST_LINK03:host-3.6070
  -HOST_LINK04:host-4.6080
*-SDS_LINK01:vcoa.7010
  -SDS_LINK02:vcoa.7020
  -SDS_LINK03:vcoa.7030
  -SDS_LINK04:vcoa.7040
  -HOSTLOAD:ROUNDROBIN [default: BROADCAST]
  -OUT_COT_ORULE2
  -OUT_COT_HZ2010
  -DEBUG2
  -DEBUG5
  -DEBUG9
  -DEBUG11
  -DEBUG12
  -DEBUG21
  -DEBUG22
```

NOTE: Cisco Systems recommends only setting debugs for troubleshooting or testing.

* Mandatory settings

Figure 4.5: Sample CktInt.cfg File

Table 4.1 lists and describes the configuration parameters in CktInt.cfg.

Table 4.1: CktInt.cfg Parameters

Parameters	Description
<p>-HOST_LINK0n:hostname.tcp_port (mandatory-at least one host link must be defined)</p>	<p>Specifies the logical TCP link(s) between the host(s) and the Integrated SS7 system. The following are the variables for -HOST_LINK0:</p> <p>n—The link number. Valid values are 1 to 8.</p> <p>hostname—Any valid host name (e.g. localhost).</p> <p>tcp_port—The decimal value of the TCP port logical port address (socket number) on the Integrated SS7 system to which the host connects.</p> <p>For more information on host and VCO/4K links, refer to <i>Section 1.3</i>.</p>
<p>-SDS_LINK0n:vconame.tcp_port (mandatory-at least one VCO/4K link must be defined)</p>	<p>Specifies the logical TCP link(s) between the Integrated SS7 system and The VCO/4K system. The following are the variables for -SDS_LINK0:</p> <p>n—The link number. Valid values are 1 to 8.</p> <p>vconame—The name of the VCO/4K the SS7 system is using.</p> <p>tcp_port—The decimal value of the TCP port logical port address (socket number) on the VCO/4K to which the Integrated SS7 system connects.</p> <p>There must be a one-to-one correspondence between these links and the links specified by -HOST_LINK0.</p> <p>For more information on host and VCO/4K links, refer to <i>Section 1.3</i>.</p>
<p>-HOSTLOAD:mode (optional)</p>	<p>Specifies the SS7 call load sharing mode for the hosts. Valid values are BROADCAST or ROUNDROBIN. The default is BROADCAST.</p> <p>For more information on load sharing modes, refer to <i>Section 1.3</i>.</p>
<p>-TUP_CKTMAPfilename (optional)</p>	<p>Where the user defines the filename. Specifies the TUP circuit configuration file residing in the \$XNV directory; contains the address translation parameters for SS7 circuit to VCO/4K ports. If this flag is not defined, the default file is \$XNV/tup_ckt_ss7_to_sds.</p>

Table 4.1: CktInt.cfg Parameters (Continued)

Parameters	Description
-TUP_GRPMAP filename (<i>optional</i>)	Where the user defines the filename . Specifies the TUP group configuration file residing in the \$XNV directory; contains the parameters for each trunk group. If this flag is not defined, the default file is \$XNV/tup_grp_ss7_to_sds .
-PRMORD filename (<i>optional</i>)	Where the user defines the filename . Specifies the configuration file residing in the \$XNV directory; controls the order of SS7 message parameters. The format of each line in the file is the message type followed by the ordered list of parameter types. There is a separate file for each supported variant. If this flag is not defined, the default file is \$XNV/param_ord.cfg .
-OUT_COT_ORULE rule (<i>optional</i>) -OUT_COT_HZ hz (<i>optional</i>)	Supports outbound COT; rule is the outpulse rule you set up for COT and hz is either 2010 or 1780 hertz. To use outbound COT messages, add these two parameters to the end of your CktInt.cfg file and set up the following outpulse rule and supervision template: Outpulse Rule: TIME SUP 5 FINAL SUP # Supervision Template #: TIME OK TUP Tone OKREP Refer to <i>Section 6.7.1</i> for outbound COT call flow examples.
-RESGRP filename (<i>optional</i>)	Where the user defines the filename . Specifies the resource configuration file residing in the \$XNV directory; controls Rotary/Cyclic port selection. If this flag is not defined, the default file is \$XNV/res_grp.cfg . The default behavior is to hunt resource groups in Cyclic mode. Refer to <i>Section 4.4.1.1</i> for more information on this feature.

Table 4.1: CktInt.cfg Parameters (Continued)

Parameters	Description
-DEBUGn (optional—use for troubleshooting)	n specifies the debug flag number, which must be set. The following are valid values for -DEBUGn:
	1 - High level interworking message debug
	*2 - VCO/4K Message Trace
	3 - IPC key trace
	4 - Displays switchover state machine transitions
	*5 - Host message trace
	6 - Used for detecting inability to find circuits or ports
	*9 - Message trace for non-SS7 calls
	*11 - Trace of transmitted SS7 messages
	*12 - Prints xmitted SS7 messages in detail; <i>11 must be on</i>
	13 - Displays the parm_order search
	**15 - Traces the \$DC reports received from the VCO/4K at switchover
	16 - Prints related diagnostic messages in the cktint log file concerning the Host Control of Call Load feature
	20 - Reserved for maintenance interface
	*21 - Trace of received SS7 messages
	*22 - Prints received SS7 messages in detail; <i>21 must be on</i>
	24 - Displays the undefined SS7 parameter types that were received
	25 - Trace of circuit state from AccesTUP (AI) layer
	27 - Generated SS7 primitives trace
	28 - Continuity check procedures debug
29 - Forces circuits to come into service ACTIVE_IDLE	
30 - Call processing debug	
31 - Debugs reading templates into objects	
32 - Debugs building SS7 messages from templates	

Table 4.1: CktInt.cfg Parameters (Continued)

Parameters	Description
-DEBUGn (cont.)	34 - Prints detailed information in the log file concerning protocol violations
	36 - Prints detailed information in the log file concerning call object creation and deletion
	* Standard for troubleshooting ** Standard for troubleshooting redundant systems only
	<i>NOTE: If multiple debug flags are needed, this parameter must be specified multiple times.</i>
	<i>TIP: Type dbs to display debug flags that are turned ON.</i>
-FEATURE_FLAGn (optional)	n specifies the feature flag number, which must be set. The following are valid values for -FEATURE_FLAGn:
	01 - Host receives SS7 \$EA reports for any CLFs that it sends.
	02 - Includes End of Optional Parameter (EOP) in SS7 \$EA reports.
	04 - Specifies a one-byte port address in standard mode. <i>NOTE: Not compatible with extended operational mode.</i>
	05 - Enables the Host Control Option. Allows only one host to control a call. A secondary host can assume control of a controlling host's calls by sending an SS7 \$C0 05 command.
	06 - Causes MTP link alarms to be processed by cktint and an SS7 \$F0 alarm condition report to be sent to the host.
	07 - An incoming MGB/MGU/GRS/HGB/HGU from the network, system, or isup_console generates an SS7 \$D9 Circuit Group State report to the host instead of individual \$D3 System Port Status reports.
	08 - Host message queue is not flushed when socket is dropped.
	09 - Does not drop host socket connection if the socket write is blocked.
	10 - Protocol violation messages suppressed from log file.

Table 4.1: CktInt.cfg Parameters (Continued)

Parameters	Description
-FEATURE_FLAGn (cont.)	11 - Ignores the impulse rule number in tup_ckt_ss7_to_sds file.
	12 - When a \$70 command gets rejected with "Invalid Class of Service," cktint releases a call, if one exists, and sends an \$EA report (CBK for incoming call or CLF for outgoing call) to the host and a \$70 on-hook command to the VCO/4K.

4.4.1.1 Rotary/Cyclic Port Selection

This parameter allows you to specify the mode that the system uses for hunting and allocating a circuit for a call.

In CYCLIC mode, the system selects the circuits from the resource group in a sequential manner; the next IDLE circuit in the group is selected for the new call. After the system has selected the last circuit in the sequence, it begins hunting from the first circuit in the group.

In ROTARY mode, the system always begins hunting sequentially from circuit # 1. The first IDLE circuit in the sequence is always selected for the new call.

You *must* modify the default resource group file, called **res_grp.cfg** in the **\$XNV** directory, to suit the needs of your installation with any UNIX text editor. You can rename the file, but the renamed file must still reside in the **\$XNV** directory for this feature to work. Figure 4.6 is an example of a **res_grp.cfg** file with 12 resource groups configured.

Resource Group	VCO/4K Device	Circuit Selection Mode
1	0	ROTARY
2	0	ROTARY
3	0	ROTARY
4	0	ROTARY
5	0	CYCLIC
6	0	CYCLIC
7	0	CYCLIC
8	0	ROTARY
9	0	ROTARY
10	0	ROTARY
11	0	ROTARY
12	0	CYCLIC

Figure 4.6: Resource Group Configuration File Example

Table 4.2 summarizes the fields in the resource group configuration file.

Table 4.2: Resource Group Configuration File Fields

Field	Definition
Resource Group	You can define from 1 to 63 resource groups in standard mode and 1 to 223 resource groups in extended 4K mode.
VCO/4K Device	Reserved. Always 0.
Selection Mode	CYCLIC or ROTARY. This mode applies to all circuits in the resource group.

NOTE: The default behavior of the res_grp.cfg file is to hunt resource groups in CYCLIC mode.

4.4.2 Resource Provisioning Files: tup_ckt_ss7_to_sds & tup_grp_ss7_to_sds

The configuration files **tup_ckt_ss7_to_sds** and **tup_grp_ss7_to_sds** contain the parameters for provisioning the circuit IDs and the circuit groups. The circuit configuration file **tup_ckt_ss7_to_sds** defines parameters for SS7 circuits. The circuit group configuration **tup_grp_ss7_to_sds** file defines parameters for circuit groups. Sample **tup_ckt_ss7_to_sds** and **tup_grp_ss7_to_sds** files already exist in directory `~/sys/CktintAnEnv`. You can modify the sample files to suit the needs of your installation.

4.4.2.1 tup_ckt_ss7_to_sds

The **tup_ckt_ss7_to_sds** file contains the address translation parameters for SS7 circuit to VCO/4K ports. Each line in the file corresponds to a single circuit. Figure 4.7 is an example of a **tup_ckt_ss7_to_sds** file for a configuration with two Single Span E1 cards.

*NOTE: **CCTNUM** is a hex value in the **tup_ckt_ss7_to_sds** file. In other configuration files (i.e., .mml configuration file) **CCTNUM** is a decimal value.*

VCO Port Address	CCTNUM	VCO Device	Circuit Name	GRPID	Inpulse Rule No.	TRNKGRPID	Signaling Point	Resource Group
101	1	0	101TOISNOD	1	0	4	0	8
102	2	0	102TOISNOD	1	0	4	0	8
103	3	0	103TOISNOD	1	0	4	0	8
104	4	0	104TOISNOD	1	0	4	0	8
105	5	0	105TOISNOD	1	0	4	0	8
106	6	0	106TOISNOD	1	0	4	0	8
107	7	0	107TOISNOD	1	0	4	0	8
108	8	0	108TOISNOD	1	0	4	0	8
109	9	0	109TOISNOD	1	0	4	0	8
10A	A	0	10ATOISNOD	1	0	4	0	8
10B	B	0	10BTOISNOD	1	0	4	0	8
10C	C	0	10CTOISNOD	1	0	4	0	8
10D	D	0	10DTOISNOD	1	0	4	0	8
10E	E	0	10ETOISNOD	1	0	4	0	8
10F	F	0	10FTOISNOD	1	0	4	0	8
110	10	0	110TOISNOD	1	0	4	0	8
111	11	0	111TOISNOD	1	0	4	0	8
112	12	0	112TOISNOD	1	0	4	0	8
113	13	0	113TOISNOD	1	0	4	0	8
114	14	0	114TOISNOD	1	0	4	0	8
115	15	0	115TOISNOD	1	0	4	0	8
116	16	0	116TOISNOD	1	0	4	0	8
117	17	0	117TOISNOD	1	0	4	0	8
118	18	0	117TOISNOD	1	0	4	0	8
119	19	0	117TOISNOD	1	0	4	0	8
11A	1A	0	117TOISNOD	1	0	4	0	8
11B	1B	0	117TOISNOD	1	0	4	0	8
11C	1C	0	117TOISNOD	1	0	4	0	8
11D	1D	0	117TOISNOD	1	0	4	0	8
11E	1E	0	117TOISNOD	1	0	4	0	8
11F	1F	0	117TOISNOD	1	0	4	0	8

Figure 4.7: Sample tup_ckt_ss7_to_sds Configuration File

	CCTNUM	VCO Device		Circuit Name	GRPID	Inpulse Rule No.	TRNKGRPID	Signaling Point	Resource Group
VCO Port Address	121	1	0	121TOISNOD	2	0 5 0 9			
	122	2	0	122TOISNOD	2	0 5 0 9			
	123	3	0	123TOISNOD	2	0 5 0 9			
	124	4	0	124TOISNOD	2	0 5 0 9			
	125	5	0	125TOISNOD	2	0 5 0 9			
	126	6	0	126TOISNOD	2	0 5 0 9			
	127	7	0	127TOISNOD	2	0 5 0 9			
	128	8	0	128TOISNOD	2	0 5 0 9			
	129	9	0	129TOISNOD	2	0 5 0 9			
	12A	A	0	12ATOISNOD	2	0 5 0 9			
	12B	B	0	12BTOISNOD	2	0 5 0 9			
	12C	C	0	12CTOISNOD	2	0 5 0 9			
	12D	D	0	12DTOISNOD	2	0 5 0 9			
	12E	E	0	12ETOISNOD	2	0 5 0 9			
	12F	F	0	12FTOISNOD	2	0 5 0 9			
	130	10	0	130TOISNOD	2	0 5 0 9			
	131	11	0	131TOISNOD	2	0 5 0 9			
	132	12	0	132TOISNOD	2	0 5 0 9			
	133	13	0	133TOISNOD	2	0 5 0 9			
	134	14	0	134TOISNOD	2	0 5 0 9			
	135	15	0	135TOISNOD	2	0 5 0 9			
	136	16	0	136TOISNOD	2	0 5 0 9			
	137	17	0	137TOISNOD	2	0 5 0 9			
	138	18	0	138TOISNOD	2	0 5 0 9			
	139	19	0	139TOISNOD	2	0 5 0 9			
	13A	1A	0	13ATOISNOD	2	0 5 0 9			
	13B	1B	0	13BTOISNOD	2	0 5 0 9			
	13C	1C	0	13CTOISNOD	2	0 5 0 9			
	13D	1D	0	13DTOISNOD	2	0 5 0 9			
	13E	1E	0	13ETOISNOD	2	0 5 0 9			
	13F	1F	0	13FTOISNOD	2	0 5 0 9			

Figure 4.7 (Continued): Sample tup_ckt_ss7_to_sds Configuration File

Table 4.3 lists and describes the fields shown in Figure 4.7.

Table 4.3: Circuit Configuration Fields

Configuration Field	Description
VCO/4K Port Address	Hex value representing the VCO/4K port address.
CCTNUM	Circuit number. Hexadecimal value. Use the same value as in the EBS SS7 stack configuration file, but convert to a hexadecimal number. See Figure 4.4.
VCO/4K Device	Reserved. Set to zero (0).
Circuit Name	40-character ASCII string.
GRPID	Circuit Group ID. Use the same value as in the EBS SS7 stack configuration file (see Figure 4.4).
Inpulse Rule Number	Reserved. Set to zero (0).
TRNKGRPID	Trunk Group ID. Use the same value as in the EBS SS7 stack configuration file (see Figure 4.4). Valid values are decimal, 1 through 75 in 2K Mode; 1 through 171 in 4K Mode.
Signaling Point	Set to zero (0). The signaling point for this device is always 0.
Resource Group	You can define from 1 to 63 resource groups in standard mode and 1 to 223 resource groups in extended 4K mode.

4.4.2.2 `tup_grp_ss7_to_sds`

Each line in the `tup_grp_ss7_to_sds` file specifies parameters for a single trunk group. You must add a space and the 12-character string for the Common Language Location ID CLLI code after each circuit group. An example line from a `tup_grp_ss7_to_sds` file is shown in Figure 4.8.

```

      4 1 MYGP-4-YRGP-1-SDS- RGRP-18 MANCHNHS001
      |-----|
TRNKGRPID |           Group Name           CLLI Code
Glare Control
  
```

Figure 4.8: Sample Line From `tup_grp_ss7_to_sds` File

Table 4.4 lists and describes the fields in the **tup_grp_ss7_to_sds** file.

Table 4.4: Circuit Group Configuration Fields

Configuration Field	Description
TRNKGRPID	Trunk Group ID. Use the same value as in the EBS SS7 Stack configuration file (see Figure 4.4). Valid values are decimal, 1 through 75 in 2K Mode; 1 through 171 in 4K Mode.
Glare Control	<p>Use for double seizing control indicator in Circuit Group Characteristics Indicator parameter. The following are the valid values for Glare Control:</p> <ul style="list-style-type: none"> 0 - Control no circuits. 1 - Control odd circuits. 2 - Control even circuits. 3 - Control all circuits. <p><i>NOTE: Glare control configuration setting in CktInt must match EBS glare configuration setting for ALL, NONE, EVEN, and ODD.</i></p> <p><i>If EBS glare configuration is set to "DEFAULT," CktInt glare should be set to ODD if the local/VCO4K point code is lower than the remote point code. Otherwise, CktInt glare should be set to EVEN if the local/VCO4K point code is higher than the distant end point code.</i></p> <p><i>For networks where the VCO4K is connected to more than one remote point code, it is possible to have a mix of both EVEN and ODD glare control if the distant end point codes are both lower and higher, respectively, than the local VCO4K point code.</i></p>
Group Name	40-character ASCII group name
CLLI Code *	Common Language Location ID code. 12-character string.

* Bytes 1-5 are the town code, bytes 6 and 7 are the state code, bytes 8 and 9 are building codes, bytes 10 and 12 are subdivision codes.

4.5 REDUNDANCY CONFIGURATION

NOTE: In order for redundancy to operate properly, the same version of the Integrated SS7 software must be installed on both sides of the system.

NOTE: A host must be connected to both the active and standby sides of the SS7 system for reliable redundancy operation.

NOTE: TUP redundancy differs from ISUP redundancy; the database files on one side must be cross-mounted on the other side.

1. Configure the VCO/4K Feature Flags for Redundancy:
 - a. Log into the VCO/4K System Administrator Console side A.
 - b. From the Main Menu, select System Configuration Menu. From the System Configuration Menu, select System Feature Configuration. The System Features Display screen appears.
 - c. Set the following flags on the System Features Display:
 - Redundant System: **Y**
 - Revert to Basic Redundancy: **N**

For more information, refer to the *System Administrator's Guide*.

2. Set the SS7 Selector Switch to "Auto" mode.
3. Log in as **root** to the Integrated SS7 system side A, **<hostname>a**.
4. Change permissions on the **.cshrc** script by entering the following command and pressing **Return**:

```
chmod 644 $HOME/.cshrc
```
5. Use the vi editor to open the file **\$HOME/.cshrc** and perform the following steps:
 - a. Remove the comment symbol (#) from the following line:

```
#setenv PLTFRMTYP REDUNDANT
```
 - b. Add the comment symbol (#) to the following line:

```
setenv PLTFRMTYP STANDALONE
```
 - c. Add the following line:

```
setenv EBSHOME /export/home/EBS
```
 - d. Save the changes and close the file.
6. To have the change take affect (without logging out and logging back in again), enter the following command and press **Return**.

```
source $HOME/.cshrc
```
7. Enter the following command and press **Return**:

```
chmod 644 $EBSHOME/access/config/AccessRd.cfg
```

8. Use the vi editor to open the file **\$EBSHOME/access/config/AccessRd.cfg**.

- a. Check the following lines. The lines should read:

```
SERIAL_PORT          /dev/ttyb
SWITCH_TYPE          4_PORT
STATE_CHANGE_TIMER   20
PAUSE_TIMER          2
ACTION_ORDER         START_SCRIPT SEND_MSG
MONITOR_OPTION       OFF
CTS_CONFIGURATION    INVERTED
SWITCH_OVER          ENABLED
STATE_CHANGE_MAX     5
HOST-A               <A-side Integrated SS7 system name>
                    (i.e., HOST-A tsup6ss7a)
HOST-B               <B-side Integrated SS7 system name>
                    (i.e., HOST-B tsup6ss7b)
```

- b. If the lines do not match, modify them accordingly.

- c. Save the changes and close the file.

9. Cross-mounted files must be configured in the **/etc/vfstab** file. Use the vi editor to open the file and add the following line:

```
<B-side Integrated SS7 system name>:/export/home/access/dat
- /export/home/EBS/access/rd  nfs - yes soft,bg
```

10. The share option must be configured in the **/etc/dfs/dfstab** file. Use the vi editor to open the file and add the following line:

```
share -F nfs -o rw,root=<B-side Integrated SS7 system name>
/export/home/EBS/access/dat
```

11. To load the rd file, enter the following command and press **Return**:

```
exportfs -a
```

12. Confirm proper configuration by entering the following line and pressing **Return**:

```
exportfs
```

- Messages similar to the following should appear:

```
/export/home/EBS/access/dat  rw,root=<B-side Integrated SS7 system name>  ""
```

13. To mount the rd file, enter the following commands and press **Return** after each:

```
/usr/lib/nfs/mountd
/usr/lib/nfs/nfsd -a 16
mount /export/home/EBS/access/rd
```

14. Confirm NFS is mounted properly by entering the following line and pressing **Return**:

```
df -k /export/home/EBS/access/rd
```

Messages similar to the following should appear:

```
vt-8ss7a# df -k /export/home/EBS/access/rd
Filesystem      kbytes  used  avail capacity  Mounted on
vt-8ss7b:/export/home/EBS/access/dat
                677880 540344 76528   88%  /export/home/EBS/access/rd
```

15. Set the Level 2 timer T0 to 160 msec.

- a. Enter the following command and press **Return**:

```
mml 0
MODIFY-L2TIMER:TIMER=0,VALUE=160;
```

- b. Confirm proper settings by entering the following line and pressing **Return**:

```
DISPLAY-L2TIMER:TIMER=0;
```

16. Log in as **root** to the Integrated SS7 system side B, <hostname>b, and repeat Step 4 through Step 15.

- a. This time, the line in Step 9 should read:

```
<A-side Integrated SS7 system name>:/export/home/access/dat
- /export/home/EBS/access/rd  nfs – yes soft,bg
```

- b. The line in Step 10 should read:

```
share -F nfs -o rw,root=<A-side Integrated SS7 system name>
/export/home/EBS/access/dat
```

- c. The line in Step 11 should still read:

```
exportfs -a
```

- d. The message returned in Step 12 should be similar to the following:

```
/export/home/EBS/access/dat  rw,root=<A-side Integrated SS7 system name>  ""
```

- e. The messages returned in Step 14 should be similar to the following:

```
vt-8ss7b# df -k /export/home/EBS/access/rd
Filesystem      kbytes  used  avail capacity  Mounted on
vt-8ss7a:/export/home/EBS/access/dat
                578920 533512 44824   93%  /export/home/EBS/access/rd
```

17. Check to make sure the SS7 Integrated Software version matches that on side A. Enter the following commands and press **Return** after each:

```
%cd $XNV
```

```
%version cktint
```

18. To bring the Integrated SS7 system into operation, go to *Section 5* and start the SS7 stack and Circuit Interworking software.

4.6 2K TO 4K AND 4K TO 2K CONFIGURATOR

4.6.1 2k to 4k Configurator Software

The 2k to 4k Configurator software allows you to configure Circuit Interworking from 2K ports to 4K ports. Running in 4K mode requires an extended host API.

NOTE: To use this option, your VCO must be licensed/configured for 4K ports.

4.6.2 4k to 2k Configurator Software

The 4k to 2k Configurator software allows you to reconfigure Circuit Interworking back to 2K ports after configuring the system for 4K ports. The extended host API option is supported in either mode.

4.6.3 Installation

In order to run the configuration software, you must complete the following steps:

1. If you haven't already done so, install the Integrated SS7 software (V5.0 FSR00 or above) as described in the appropriate system supplement.
2. Log on as **root**.
3. Change directory **cd** to **/export/home**.
4. Enter the following command and press **Return**:

```
/etc/init.d/volmgt stop
```

5. Copy the configurator diskette to the system drive:
 - a. Insert the configurator diskette (contains 2kto4k and 4kto2k executables) into your storage subsystem's floppy disk drive.
 - b. Enter the following command and press **Return**:

```
cpio -icduv -C65536 -I/dev/rfd0
```

- c. When the system is finished copying the disk, enter the following command and press **Return**:

```
/etc/init.d/volmgt start
```

6. If necessary, change permissions on the executable files by entering the following command and pressing **Return**:

```
chmod +x ./2kto4k ./4kto2k
```

7. Run either the **2kto4k** or **4kto2k** executable, depending on the desired configuration.
8. For the changes to take effect, reboot your system by typing **boot** and pressing **Return**.
9. If you have a redundant configuration, repeat Step 5 through Step 8 on the other side.

NOTE: If Solaris OS is re-installed any time after this process, you must re-copy and re-run the configurator software.

4.6.4 Checksums and Sizes

2k to 4k Configurator Software

File Name	Checksum /usr/bin/sum	Size ls -l
2kto4k	15747 148	75768

4k to 2k Configurator Software

File Name	Checksum /usr/bin/sum	Size ls -l
4kto2k	42158 147	75140

Section 5

SYSTEM ADMINISTRATION

5.1 INTRODUCTION

The Integrated SS7 system requires little user interaction during normal day-to-day operation. This section focuses on basic system initialization and monitoring functions that are performed through the UNIX command line. This section is divided into the following areas:

- Starting the SS7 Stack and Circuit Interworking software and configuring for Autostart
- Monitoring the SS7 link status and log files
- Managing the circuit and circuit groups
- Initiating a switchover
- Bringing down the Integrated SS7 system
- Using scripts/alias

The Integrated SS7 system is configured for two users: **root** and **cktint**. Use **cktint** when performing Circuit Interworking functions.

*NOTE: The initial password is factory-configured as "abc123" for **root** and **cktint**. However, the password may have been changed when the Circuit Interworking software was installed. If you do not know **cktint**'s password, contact your network administrator.*

5.2 STARTING THE SS7 STACK AND CIRCUIT INTERWORKING

To start the SS7 stack and Circuit Interworking, complete the following steps:

1. Log in as **cktint**.
2. Enter the following command and press **Return**:

start-ss7.sh

The following messages appear:

```
This script will assist you in bringing up your Integrated
SS7 system in a controlled fashion.
```

```
Would you like to start the EBS stack [y/n]?y
```

3. Type **y** and press **Return**. Messages similar to the following appear:

```
%start-ss7.sh

This script will assist you in bringing up your Integrated
SS7 system in a controlled fashion.

Would you like to start the EBS stack [y/n]?y

Starting Signaling Point 0
Starting ebs_start...

Signalling Point Manager - Version 3.5
Copyright (c) ADC NewNet, Inc.
All Rights Reserved

Loading /dev/ecp0 - device does not exist
Loading /dev/ecp1 - device does not exist
Loading /dev/ecp2 - device does not exist
Loading /dev/ecp3 - device does not exist
Loading /dev/ecp4 - device does not exist
Loading /dev/ecp5 - device does not exist
Loading /dev/ecp6 - device does not exist
Loading /dev/ecp7 - device does not exist
Loading /dev/ecpt0
Loading /dev/ecpt1 - device does not exist
Loading /dev/ecpt2 - device does not exist
Loading /dev/ecpt3 - device does not exist
Loading /dev/ecpt4 - device does not exist
Loading /dev/ecpt5 - device does not exist
Loading /dev/ecpt6 - device does not exist
Loading /dev/ecpt7 - device does not exist
AccessMANAGER Ready

*****
***** AccessALARM is in service *****
***** Console Output is DISABLED *****
*****

Starting upmd...

User Part Manager - Version 3.5
Copyright (c) ADC NewNet, Inc.
All Rights Reserved

UPMD #0 : Waiting <snmd> to start
Starting snmd...

Signalling Network Manager - Version 3.5
Copyright (c) ADC NewNet, Inc.
All Rights Reserved

UPMD #0 : <snmd> started, loading prestored data
UPMD #0 : MTP Started
UPMD #0 : EBSRUN is set to /export/home/EBS/access/RUN0
UPMD #0 : Protocol type is CHINA
```

```
Starting AccessTUP...
EBS SS7 is now started.
```

```
Would you like to start the Circuit Interworking (CktInt) software?
(Note: You should not start CktInt without the EBS stack running!) [y/n]y
```

```
Starting cktint ...
. . . . .
Circuit Interworking is now started.
```

4. Type **y** and press **Return**. The following message appears:

```
Starting cktint ...
. . . . .
Circuit Interworking is now started.
```

5.3 CONFIGURING CktInt AND SS7 STACK FOR AUTOSTART

You can configure the system for autostart, so that the SS7 stack and Circuit Interworking are automatically started at system boot. To configure for autostart, either choose the autostart option during CktInt installation, or complete the following steps:

1. Log in as **root**.
2. Enter **cp \$BIN/S85ss7 /etc/rc3.d**.

The autostart process takes approximately 20 minutes to execute after SPARC reboot.

*NOTE: Autostart may be configured when running **install_cktint.sh**.*

5.4 MONITORING THE SS7 LINK STATUS

This section describes how to display link status and how to enable SS7 message logging.

5.4.1 Display Link Status

To display the link status, complete the following steps:

1. Enter the following command and press **Return**:

```
ss7-links
```

Figure 5.1 is an example of the output from the **DISPLAY-LINK** command. Possible values for **STATE** are as follows:

- A (aligned), which indicates that the link is up and active
- F (failed), which indicates that the links failed to align and that they are down
- LI (locally inhibited)
- RI (remotely inhibited)

LINK	PORT	LSET	SLC	STATE	ACTIVATED	TYPE
STP-MAN-0	1	STP-MAN	0	-F	NO	DTE
STP-CONC-0	2	STP-CONC	0	-A	YES	DTE
STP-CONC-1	3	STP-CONC	1	-F	NO	DTE

Figure 5.1: Sample Link Status Display

2. To exit the link status display, enter **Exit;** and press **Return**.

5.4.2 Daily Log Files

The system creates and stores daily log files in the **\$XNV/log** directory. The system does not automatically delete older files. Older log files must be deleted to recover disk space.

5.4.3 Enabling and Disabling SS7 Message Logging

You can enable the SS7 message log file to allow capture of the SS7 messages that are received from the SS7 network and sent to Circuit Interworking, and the SS7 messages that are received from Circuit Interworking and sent to the SS7 network. This feature is useful for diagnosing problems and should not be enabled during normal operation.

To enable SS7 message logging, complete the following steps:

1. Log on as **cktint**.
2. Start the message logging process by entering the following command and pressing **Return**:

```
ebslog on
```

This command causes the messages to be logged in the file `/tmp/LOG.out`.

To disable SS7 message logging, complete the following steps:

1. Log on as **cktint**.
2. Kill the logd process by entering the following command and pressing **Return**:

```
ebslog off
```

5.5 MANAGING CIRCUITS AND CIRCUIT GROUPS (ISUP_CONSOLE)

When Circuit Interworking is running, you can use the **isup_console** program, which provides you with the following management functions:

Blocking (b) — Generates a Block (BLO) or Circuit Group Block (CGB) message for the specified circuit or circuit group.

Debug (d) — Allows debug flags to be turned ON or OFF. Displays all debug flags that are turned ON. If no debug flags are ON, the message “No debug switches are active” is displayed.

NOTE: Use the “d” command to toggle each debug flag. The same debug functions can be specified in the CktInt.cfg file (refer to Section 4.4). Table 4.1 lists and defines valid values for the debug flags.

Feature Flags (f) — Allows feature flags to be enabled or disabled. Displays all the feature flags that have been enabled. If no feature flags are enabled, the message “No feature flags are enabled” is displayed.

NOTE: Use the “f” command to toggle each feature flag. The same feature flags can be specified in the CktInt.cfg file (refer to Section 4.4). Table 4.1 lists and defines valid values for the feature flags.

Help (h) — Lists all **isup_console** option definitions.

Ingest Circuit State (i) — Generates a request to the Circuit Interworking module to retrieve and ingest circuit state information from the TUP layer of the SS7 stack.

Host Link Status (l) — Displays the status of the host computer TCP links. The values for Host Link Status are NOT CONFIGURED, OFFLINE, CONNECTED, and ONLINE_READY.

Load Sharing Mode (m) — Allows you to change the host load sharing mode. Load sharing modes are ROUNDROBIN or BROADCAST.

Reset (r) — Generates a Reset (RSC) or Group Reset (GRS) message for the specified circuit or circuit group.

Status Report (s) — Displays the current status of the requested circuit or circuit group.

Switchover (S) — Causes a system switchover.

NOTE: There are two options available for switchover: 1) switchover with reset (initiates Autostart if it is configured) and 2) switchover without reset. The difference between the two options is that option 1 resets the previously active VCO/4K side after transfer.

Unblocking (u) — Generates an Unblock (UBL) or Maintenance Group Unblock (MGU) message for the specified circuit or circuit group.

Exit (x) — Exits the **isup_console** program.

The **isup_console** program is located in the **~/sys/CktIntAnEnv** directory. This directory is aliased by **\$XNV**.

To run **isup_console**, enter the following command and press **Return**:

```
isup_console
```

NOTE: CktInt must be running to use the isup_console program.

5.5.1 Examples

This section contains examples that describe how to use the **isup_console** program.

Example 1

To obtain either a Circuit or Group Status Report, complete the following steps:

1. Start **isup_console**. The main prompt (shown below) appears:

```
Enter a command (b, d, f, h, i, l, m, r, s, S, u, x):
```

2. Type **s** and press **Return**. The following prompt requests input as to whether you want information on a circuit or circuit group.

```
Enter a group or circuit (g, c):
```

3. Enter **c** for circuit. The following prompt appears:

```
Enter a circuit ID:
```

4. Enter the circuit ID and press **Return**. The following prompt appears:

```
Enter a trunk group:
```

5. Enter the trunk group number and press **Return**. A Circuit Status Report similar to the report in Figure 5.1 appears:

```

SDS Port Address: 408
SDS Port In Service:Yes
SDS Card In Service:Ye
SS7 Circuit Address:0
SS7 Circuit Type: TUP
Circuit State: Active
Call State: Idle
Sub State: Idl
SDS Device:
Circuit Name: GRPID-001-CIC-032-GCIC-032
Group Number: 1
Impulse Rule Number:0
Signalling Point: 0
CIC (From Network): 32
GCIC(From CktInt): 2
Trunk Group:
Resource Group: 1
Control Host: NONE
```

```
Enter a command (b, d, f, h, i, k, l, m, r, s, S, u, x):
```

Figure 5.2: Sample Status Display

Example 2

To block a circuit, complete the following steps:

1. Start **isup_console**. The main prompt appears:

```
Enter a command (b, d, f, h, i, l, m, r, s, S, u, x):
```
2. Type **b** and press **Return**. The following prompt requests input as to whether you want to block a circuit or circuit group:

```
Enter a group or circuit (g, c):
```
3. Enter **c** for circuit. The following prompt appears:

```
Enter a circuit ID:
```
4. Enter the circuit ID and press **Return**. The following prompt appears:

```
Enter a trunk group:
```
5. Enter the trunk group number and press **Return**. The blocking message is generated for the circuit you specified, and the main prompt reappears.
6. To exit **isup_console**, type **x** and press **Return**.

Example 3

To display host link status, complete the following steps:

1. Start **isup_console**. The main prompt appears:

```
Enter a command (b, d, f, h, i, l, m, r, s, S, u, x):
```
2. Type **l** and press **Return**. The following prompt appears:

```
Enter the Link Identifier (1-8) or 'a' for all links
```
3. Enter the link identifier and press **Return**. The following messages appear:

```
HOST                STATE                SDS                STATE  
LINK0n:host-name    tcp_portlink_state    sds-name          tcp_portlink_state
```

Where,

n = the link number, **hostname** = the name of the host computer, and **tcp_port** = the hexadecimal value of the logical port address between the Integrated SS7 system and the host system

tcp port link state = NOT CONFIGURED, OFFLINE, CONNECTED, ONLINE_READY, ONLINE_RESTRICTED, or ONLINE_NOT_READY

sds-name = the name of the VCO/4K and **tcp_port** = the hexadecimal value of the corresponding logical link between the Integrated SS7 and VCO/4K

Example 4

To switch the host load sharing mode, complete the following steps:

1. Start `isup_console`. The main prompt appears:

```
Enter a command (b, d, f, h, i, l, m, r, s, S, u, x):
```

2. Type `m` and press **Return**. Prompts similar to the following appear:

```
Current Host Load Sharing Mode = BROADCAST
```

```
Toggle Host Load Sharing Mode = y/n
```

3. To switch the load sharing mode, type `y` and press **Return**. Prompts similar to the following appear:

```
Current Host Load Sharing Mode = ROUNDROBIN
```

```
Toggle Host Load Sharing Mode = y/n
```

4. Type `n` and press **Return**. The main prompt reappears.

5.6 INITIATING A SWITCHOVER

This subsection only applies to redundant configurations.

There are a number of ways to initiate a switchover. However, for optimum results, Cisco Systems recommends that you use only the following procedures, listed in order of preference:

1. Send a Change Active Controllers (`$C0 01`) command from the host. This command can be sent to either the active or the standby side of the VCO/4K. (Refer to the *Programming Reference* for information on the `$C0 01` Command.)
2. Run the Switch Active Side to Standby utility from the VCO/4K System Administration Console on the active side of the system. (Refer to the *System Administrator's Guide* for information on the utility.)
3. Run the `isup_console` utility from the Integrated SS7 System Administration Console on the active side of the system and issue an `S` command (refer to *Section 5.5*).

Switchover does not occur if the host is not connected to both sides, the VCO/4K standby side is not up and running, or file synchronization with the active side was unsuccessful.

NOTE: Switchovers initiated from the SS7 selector switch or MML commands are not supported. These methods do not send messages to the VCO/4K Generic and conflicts could arise, such as, the Generic attempting to switch from side A to side B, while the MML commands or the selector switch are attempting to switch from side B to side A.

Do not initiate a switchover by flipping the A/B toggle switches on the VCO/4K Alarm Arbiter card or the SS7 selector switch. Keep both these A/B toggle switches in the AUTO position during normal operation, as shown in Figure 5.3 and Figure 5.4.

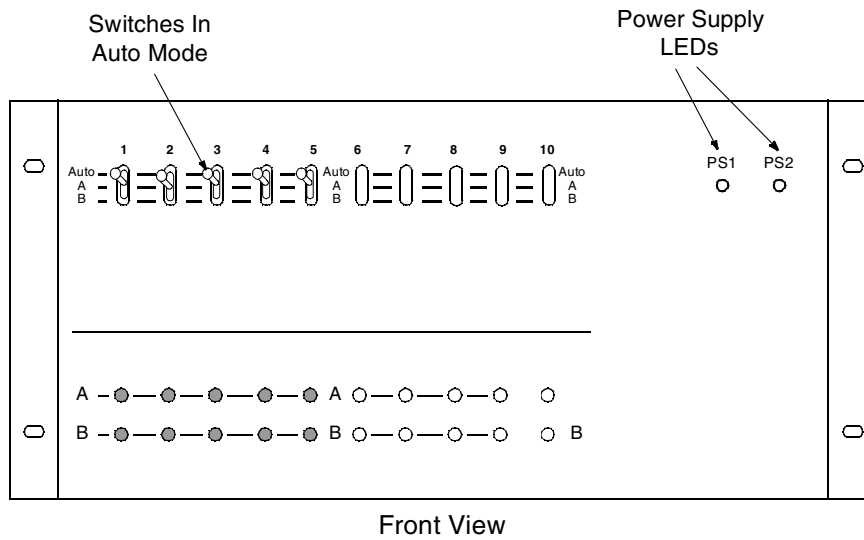

Figure 5.3: SS7 Selector Switch A/B Toggle Switch In AUTO Position

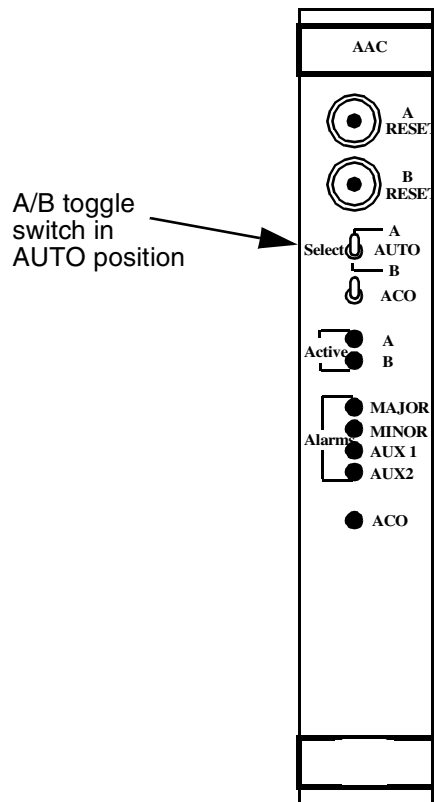

Figure 5.4: AAC A/B Toggle Switch In AUTO Position

When you perform maintenance, the A/B toggle switches can be used to lock on side A or side B after you initiate a switchover.

For example, if the Integrated SS7 and VCO/4K systems are active on side A, and you want to perform maintenance on side A, complete the following steps:

1. Send a Change Active Controllers (\$C0 01) command from the host to the VCO/4K.
2. When the system has switched over to side B, set the toggle switches on the AAC and the SS7 selector switch to position B.
3. Perform the maintenance procedure on side A.
4. Set the toggle switches on the AAC and SS7 selector switch to AUTO. This forces the Integrated SS7 and VCO/4K systems to switch over so that the active side is side A.

If the Integrated SS7 and VCO/4K systems are on the side B, and you want to perform maintenance on side B, complete the following steps:

1. Send a Change Active Controllers (\$C0 01) command from the host to the VCO/4K.
2. When the system has switched over to side A, set the toggle switches on the AAC and the SS7 selector switch to position A.
3. Perform the maintenance procedure on side B.
4. Set the toggle switches on the AAC and SS7 selector switch to AUTO. The Integrated SS7 and VCO/4K systems will remain active on side A.

5.7 BRINGING DOWN THE INTEGRATED SS7 SYSTEM

To bring down the Integrated SS7 system, complete the following steps:

1. Log in as **cktint**.
2. Stop SS7 by entering the following command and pressing **Return**:

stop-ss7.sh

The following messages appear:

```
This script will assist you in bringing down your Integrated
SS7 system in a controlled fashion.
```

```
Would you like to halt the Circuit Interworking (CktInt) software? [y/n]
```

3. Type **y** and press **Return**. Messages similar to the following appear:

```
Checking for process cktint...
Stopped cktint using kill -3 791
 792
.
Circuit Interworking is now stopped.

Would you like to halt the EBS software? [y/n]
```

4. Type **y** and press **Return**. Messages similar to the following appear:

```
Checking for process AccessTUP
Stopped AccessTUP using kill -9 638
Stopping EBSs7...

EBS SS7 stack is now stopped.
```

5.7.1 Powering Down the SPARC

To power down the SPARC, complete the following steps:

1. Log in as **root**.
2. Stop SS7 by entering following Step 2 through Step 4 above.
3. Type the following command a few times, pressing **Return** after each:
sync
4. Shut down the SPARC by typing the following command and pressing **Return**:
halt
5. Once you get a boot prompt (or wait one minute if you don't have a console hooked up), power down the SPARC by hitting the power button.

5.8 REMOTE ACCESS

The Integrated SS7 system can be accessed from a remote location when the modem is connected to the system as described in *Section 2*.

To log in remotely, refer to the information in the *Solaris System & Network Administration* manual. Use the UNIX-to-UNIX copy commands (**ppp**) and Telnet/ftp commands. If you encounter any difficulties during remote login, contact Cisco Systems Technical Support.

5.9 USING SCRIPTS/ALIAS

The following alias and scripts help to streamline processes within Circuit Interworking. These are provided for convenience only; use the standard tools, such as `isup_console` or `mml 0`, if any problems arise.

NOTE: Cisco Systems does not recommend using these on a live production switch due to potentially unpredictable behavior.

Script/Alias Name	Function	Usage
dbb	Displays the CktInt debug flags that are turned ON.	dbb
dbc	Toggles the status of the debug flags specified. Type command name, followed by an empty space and the number of the flag(s) to be toggled (i.e. <code>dbc 2 3 4</code>).	dbc <debug flag(s)>
ebslog	Turns EBS logging ON/OFF.	ebslog <on/off>
px	Prints information about SS7 processes now running with a full listing.	px
rcg	Issues a "reset circuit" for each circuit in the trunk group(s). Type command name, followed by space, and group number(s) (i.e. <code>rcg 4</code>).	rcg <trnkgrpId>
rg	Used to issue a "reset circuit group" for each input trunk group. Type command name, followed by space, and the range of number(s) (i.e. <code>rg 1 -or- rg 1 2 3 -or- rg 1-3</code>).	rg <trnkgrpId>
rmdb	An alias to remove EBS database files. Must be run for each SP.	rmdb <n>
sg	Displays the status of circuits associated with the input group(s) as seen by CktInt. Type command name, followed by space, and the group number(s) (i.e. <code>sg 4</code>). <i>NOTE: Output varies according to your specific system configuration.</i>	sg <trnkgrpId>
ss7-links	Displays status of SS7 links.	ss7-links
tcp-links	Displays current TCP link status.	tcp-links

6.1 INTRODUCTION

TUP software consists of the Circuit Interworking software module and EBS SS7 stack.

*NOTE: Make sure you modified your **.cshrc** script to specify TUP operations; the default is ISUP. To modify the **.cshrc** script, do the following:*

1. Log in as **root** to the Integrated SS7 system side A, **<hostname>a**.
2. Change permissions on the **.cshrc** script by entering the following command and pressing **Return**:

```
chmod 644 $HOME/.cshrc
```

3. Use a UNIX text editor to open the file **\$HOME/.cshrc** and add the following line:

```
setenv CC_CONFIG tup
```

4. To have the change take effect (without logging out and logging back in again), enter the following command and press **Return**.

```
source $HOME/.cshrc
```

5. Log in to the Integrated SS7 system side B, **<hostname>b**, and repeat **Step 2** through **Step 4**.

The Circuit Interworking software module integrates SS7 signals with the VCO/4K, and host call processing and circuit maintenance tasks. It supports SS7-to-SS7 calls, SS7-to-VCO/4K calls, and VCO/4K-to-SS7 calls. Figure 6.1 is an illustration of Circuit Interworking.

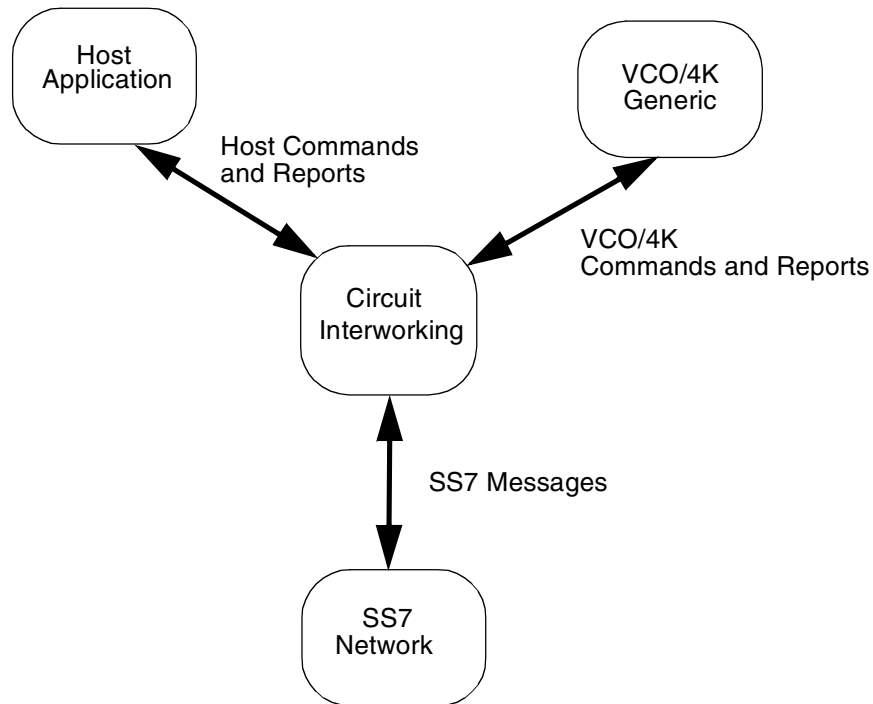

Figure 6.1: Circuit Interworking

The Circuit Interworking software communicates with the SS7 Network via SS7 message, and with the VCO/4K and host via commands and reports (see *Section 6.4*).

SS7 Messages

When the Circuit Interworking software receives an SS7 message, a host report is generated. Circuit Interworking may also generate an VCO/4K command and an SS7 message.

Refer to *Appendix E* for a list of the SS7 messages supported by circuit interworking.

6.2 TEMPLATES

The SS7 templates hide the parameter details of the SS7 message format, relieving host management. Templates also dictate the content of SS7 messages that are generated and transmitted to the SS7 network by Circuit Interworking in the \$49 command (see *Section 6.5.3* or *Section 6.6.3*). The SS7 software supports templates 32 through 63. Circuit Interworking needs message templates 32 through 38, listed below, for its internal operations.

Template Number	SS7 TUP Message Type
32	Initial Address Message (IAM)
33	Initial Address with Additional Information (IAI)
34	Address Complete Message (ACM)
35	Answer, Charge (ANC)
36	Clear Back (CBK)
37	Clear Forward (CLF)
38	Release Guard (RLG)
39 to 63	User Specified

Templates specify some, none, or all of the SS7 message parameters. Template-specified parameters and host-specified parameters are combined to create SS7 messages to be transmitted to the SS7 network. A template has the following format:

[Message Type]

[Parameter Code] [Parameter Data Length] [Parameter Data]

[Parameter Code] [Parameter Data Length] [Parameter Data]

[Parameter Code] [Parameter Data Length] [Parameter Data]

The Message Type byte is the hex value of the message (refer to SS7 protocol for these values).

*NOTE: **Do not** modify message type data within SS7 templates 32 through 38.*

Use one line in the template file for each parameter in the SS7 message. You can use as many lines as necessary to specify the parameters.

Each parameter line consists of a Parameter Code byte, a Parameter Data Length byte, and one or more Parameter Data bytes. The format and components are defined as follows:

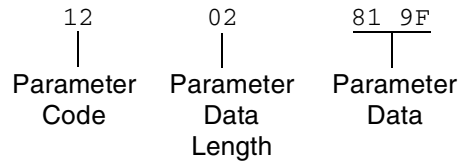

Parameter Code – Specifies the parameter code.

Parameter Data Length – Specifies the number of parameter data bytes; length of 00 indicates no parameter data.

Parameter Data – Specifies the parameter data exactly as it should be sent to the SS7 network. Code this data as it would appear in an SS7 message.

*NOTE: Templates furnished as starting points only. Template parameters **must be reviewed and modified according to your specific application requirements to prevent potential operational problems with SS7 messages.***

Template files are numbered from 1 to 31 (decimal) and have the following naming convention: template_x, where x is the template number. When you enter a template number in a command, you must convert the decimal number to hexadecimal.

The template files are stored in the **\$XNV/templates** directory. (**\$XNV** is defined as **/export/home/cktint/sys/CktIntAnEnv**.) You can edit these template files with any standard UNIX text editor. Circuit Interworking must be restarted when changes are made to the template files.

6.3 CHINA TUP STATE MACHINES

The China TUP software module contains a state machine for each of the various inputs from either the SS7 network, the host computer, or the VCO/4K.

Call control states include idle, outgoing busy, and incoming busy. Additionally, the Outgoing and Incoming Busy states include the following substates:

Outgoing Busy Substates	Incoming Busy Substates
Null/Idle	Null/Idle
Initiated	Call Present
Received	Delivered
Answered	Answered
Released	Released

NOTE: Additional substates can exist in certain call flow scenarios. For example, a continuity call flow scenario could produce Continuity, Continuity Initiated, or Continuity Call Present substates.

6.3.1 Basic State Machine

The basic state machine depicted in Figure 6.2 shows a list of events that cause transitions in states.

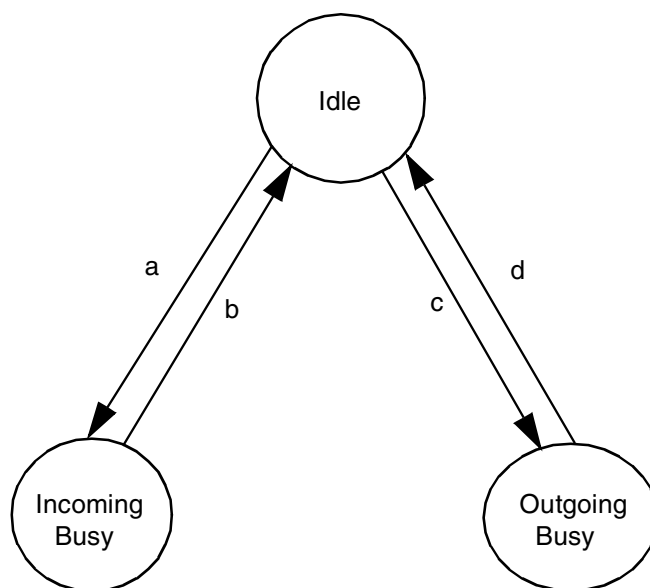

Figure 6.2: Basic State Machine

The transitions are defined as follows:

- a. IAM or IAI message received from SS7 network. Essentially this is a basic call request. This is the state of call processing for a particular call.
- b. RLG message sent to, or received from the SS7 network. This is the end of call processing for a particular call.
- c. IAM or IAI message generated for an SS7 circuit. This is the start of call processing for an outgoing call.
- d. RLG message sent of received to or from the SS7 network. This is the end of call processing for a particular call.

6.3.2 Outgoing Call Control States

The substates for the outgoing busy state are null, initiated, received, released, and answered (as shown in Figure 6.3).

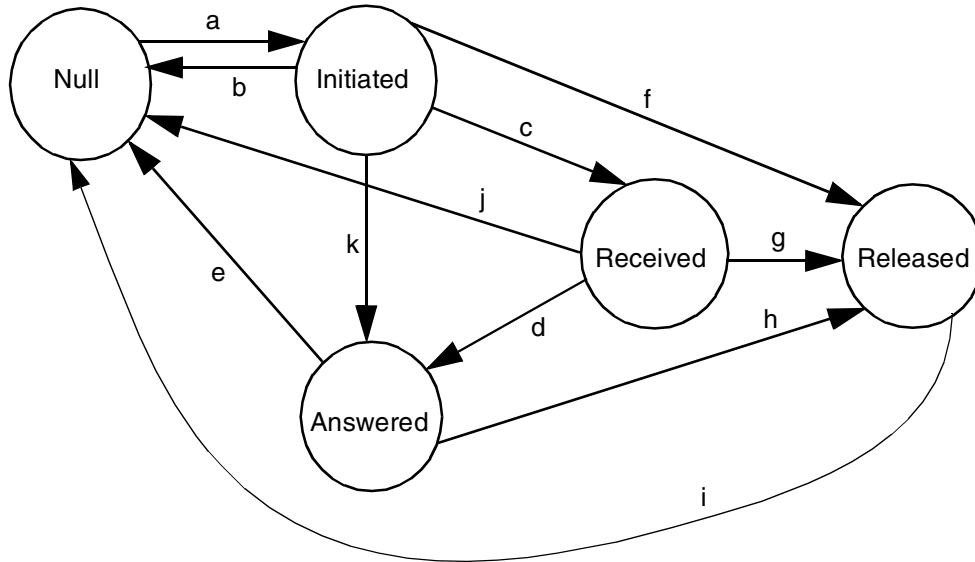

Figure 6.3: Substates for Outgoing Busy State

- a. A successful IAM or IAI message sent to the SS7 network.
- b. RLG message received from the network. The RLG is reported to the host as an \$SEA report with all the received parameters.
- c. ACM message received from the network. The ACM is reported to the host as an \$SEA report with all the received parameters.
- d. ANC, ANN, or ANU message received from the network. The ANC, ANN, or ANU is reported to the host as an \$SEA report with all the received parameters.
- e. After sending CLF message, RLG message received from the network. The RLG is reported to the host as an \$SEA report with all the received parameters.
- f. CLF message sent to the network. Host command received requesting disconnect. Incoming SS7 circuit releases, release of the associated VCO/4K outgoing channel.
- g. CLF message sent to the network. Host command received requesting disconnect. Incoming SS7 circuit releases, release of the associated VCO/4K outgoing channel.
- h. CLF message sent to the network. Host command received requesting disconnect. Incoming SS7 circuit releases, release of the associated VCO/4K outgoing channel.
- i. After sending CLF message, RLG message received from the network. The RLG is reported to the host as an \$SEA report with all the received parameters.
- j. After sending CLF message, RLG messages received from the network. The RLG is reported to the host as an \$SEA report with all the received parameters.
- k. ANC, ANN, or ANU message received from the network. The ANC, ANN, or ANU is reported to the host as an \$SEA report with all the received parameters.

6.3.3 Incoming Call Control States

A state diagram for the incoming call control states is shown in Figure 6.4. Following the figure is a description of each of the events that cause a transition from one state to the next.

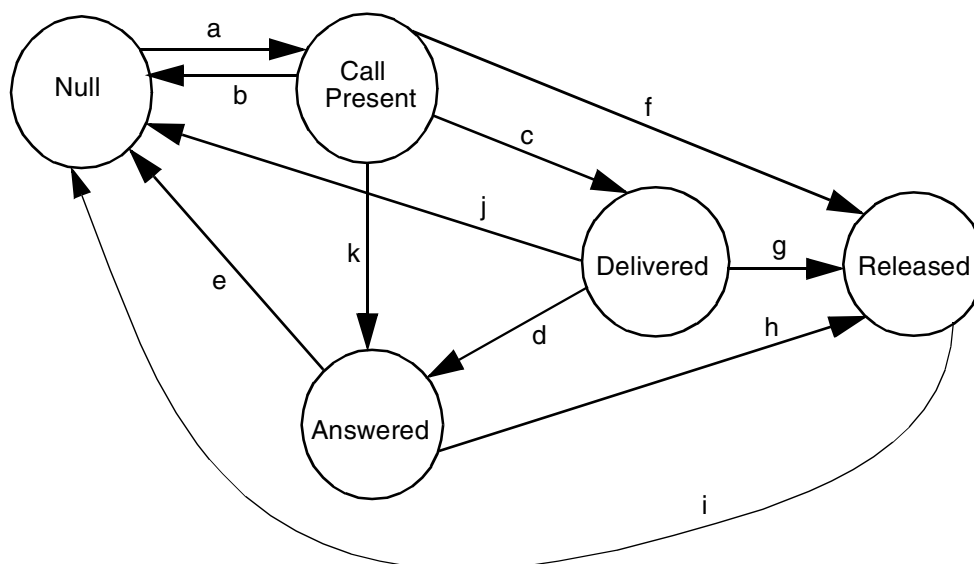

Figure 6.4: Incoming Call Control States

- a. IAM or IAI message received. This is a call request. An \$EA report to the host is generated, containing all of the received parameters.
- b. CLF message received from the network. The CLF is reported to the host as an \$EA report with all the received parameters.
- c. ACM message generated to the SS7 network.
- d. ANC, ANN, or ANU message generated to the SS7 network.
- e. CLF received from the network. This event causes an \$EA report to be generated, containing all received parameters.
- f. CBK generated to the network. Host command received to disconnect the incoming port.
- g. CBK generated to the network. Host command received to disconnect the incoming port.
- h. CBK generated to the network. Host command received to disconnect the incoming port.
- i. CLF received from the network. This event causes an \$EA report to be generated, containing all received parameters.
- j. CLF received from the network. Otherwise, an \$EA is generated containing all received parameters.
- k. ANC, ANN, or ANU message received from the network. The ANC, ANN, or ANU is reported to the host as an \$EA report with all the received parameters.

6.4 SS7 Commands and Reports Overview

The element that determines whether a command is *for* SS7 or the VCO/4K is the destination virtual communications address (VCA). Source VCAs determine whether a report is *from* SS7 or the VCO/4K. VCAs are part of the network header segment of all messages.

NOTE: Refer to the Message Structure Overview section in the Programming Reference for more information on VCAs.

Commands

If the destination VCA in the message from the host is \$C1, the command is an SS7 TUP command and is processed by the Integrated SS7 system. If the destination VCA in the message from the host is anything else, the Integrated SS7 system passes the message on to the VCO/4K. Figure 6.5 illustrates how the Integrated SS7 system handles SS7 commands.

DESTINATION VCA = \$C1

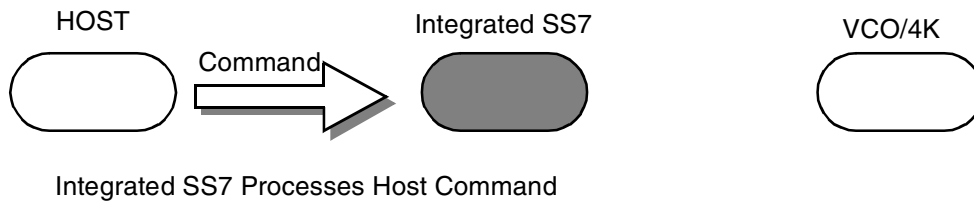

DESTINATION VCA = Anything Other Than \$C1

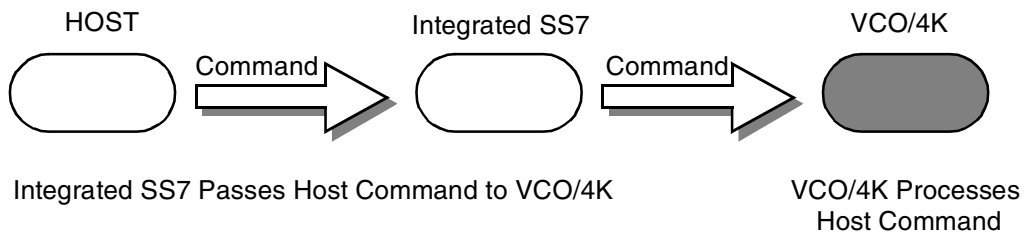
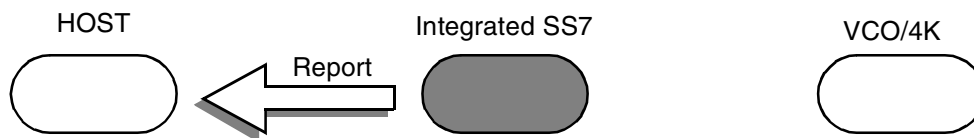

Figure 6.5: Handling of Commands by the Integrated SS7 System

Reports

If the source VCA in a message is \$C1, the report is from SS7. If the source VCA in a message is anything else, the report is from the VCO/4K. Figure 6.6 illustrates how the Integrated SS7 system handles SS7 reports.

SOURCE VCA = \$C1



Integrated SS7 Generates Report

SOURCE VCA = Anything Other Than \$C1

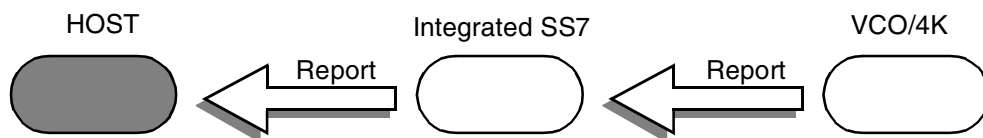

Host Processes Report

Integrated SS7 Passes Report To Host

VCO/4K Generates Report

Figure 6.6: Handling of Reports by the Integrated SS7 System

Circuit Interworking processes the \$30 01, \$30 02, \$49, \$C0 04 and \$C0 05 commands when the commands are addressed to the Integrated SS7 system (i.e., the destination VCA is set to \$C1). In addition, Circuit Interworking generates \$B0 01, \$D3, \$D9, \$EA, and \$F0 reports in response to SS7 messages.

Table 6.1 and Table 6.2 list the commands and reports that are generated and processed by the Circuit Interworking software module.

Section 6.5 and Section 6.6 describe SS7 TUP commands and reports in greater detail. Refer to the *Programming Reference* for additional information on non-SS7 commands and reports used by Circuit Interworking.

Table 6.1: Circuit Interworking Commands.

Command	Type	Description
\$30 01	System Status	SS7 Circuit Query. Initiates query of SS7 circuit states for one or all trunk groups. Generated by the host and processed by cktint.
\$30 02	Configuration Control	SS7 Circuit Synchronization. Synchronizes Circuit Interworking circuit states of one or all trunk groups. Generated by the host and processed by cktint.
\$49 ^a	Resource Control	SS7 Network Message Generation. Generates SS7 messages to the SS7 Network. Generated by the host and processed by cktint.
\$C0 04 ^a	Configuration Control	SS7 Call Processing Control. Used in conjunction with the Host Control of Call Load feature in the Generic software. When the feature is enabled, this command allows the host to indicate its ability to process all calls, existing calls only, or no calls. Generated by the host and processed by cktint.
\$C0 05 ^a	Configuration Control	SS7 Port Control. Allows a host process to relinquish control of a call assigned to itself, or assume control of a call that has been assigned to a different host. Generated by the host and processed by cktint.

a. Used in both SS7 (destination VCA of \$C1) and non-SS7 (destination VCA not \$C1) applications. For more information, refer to *Section 6.5* or *Section 6.6*.

Table 6.2: Circuit Interworking Reports

Report	Type	Description
\$B0 01	Circuit Status	SS7 Circuit Status. Reports SS7 Circuit states for a trunk group. Generated by cktint for the host.
\$D3 ^a	System Status	SS7 System Port Status. Informs the host of a change in the status of an SS7 circuit. Generated by cktint for the host.
\$D9 ^a	Circuit Group Status	SS7 Circuit Group Status. Generated when cktint receives an incoming CGB/CGU/GRS from the network, system, or isup_console.
\$EA ^a	Resource Control	SS7 Network Message Reception. Reports SS7 messages and parameters to the host. Generated by cktint for the host.
\$F0 ^a	System Status	SS7 System Alarm Status. Reports MTP OOS/IS link alarms. Generated by cktint for the host.

a. Can be either an SS7 (source VCA of \$C1) or non-SS7 (source VCA not \$C1) report. For more information, refer to *Section 6.5* or *Section 6.6*.

6.5 CIRCUIT INTERWORKING COMMANDS AND REPORTS (Standard)

This section describes the commands and reports used by the Integrated SS7 system in Standard Mode. Refer to the *Programming Reference* for additional information on non-SS7 commands and reports used by Circuit Interworking.

6.5.1 SS7 Circuit Query (\$30 01) Command (Standard)

Command Type: System Status

Description:

Initiates a query of the SS7 circuit states for one or all trunk groups. An SS7 Circuit Status (\$B0 01) report is generated back to the host.

Usage Guidelines:

You may use this command at any time, but it is recommended that its use be restricted to periods of low traffic.

Format:

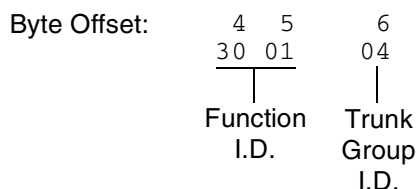

Function ID (byte offset 4 and 5) – Byte immediately following the Network Header. The Function ID uniquely identifies the command to the Integrated SS7 system.

Trunk Group Id (byte offset 6) – Specifies the trunk group to query. Must be in the range from 0 to 127. Construct byte in binary according to the descriptions below, then convert to hex for use in the command.

XYYY YYYY

X = 0 — Query trunk group specified in YYY | YYYY

X = 1 — Query all trunk groups.

YYY | YYYY = 0 – 127 – Trunk group to query.

Network Status Byte:

The following network status bytes are returned by the \$30 01 Command:

Status Byte	Meaning
\$01	Command processing accepted. Indicates command sent to the system has passed initial processing. Returned only when Return All is specified in the command's Network Control byte. No corrective action required.
\$D0	Invalid Trunk Group ID.
\$41	Invalid host message length.

6.5.2 SS7 Circuit Sync (\$30 02) Command (Standard)

Command Type: Configuration Control

Description:

Synchronizes the CktInt circuit states of one or all trunk groups with the underlying TUP layer.

Usage Guidelines:

This command may be used at anytime, but it is recommend that its use be restricted to periods of low traffic.

This command can be used in case the need arises to make sure the circuit states are consistent with what is maintained in the TUP layer.

Format:

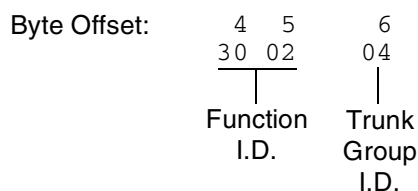

Function ID (byte offset 4 and 5) – Byte immediately following the Network Header. The Function ID uniquely identifies the command to the Integrated SS7 system.

Trunk Group Id (byte offset 6) – Specifies the trunk group to sync. Must be in the range from 0 to 127. Construct byte in binary according to the descriptions below, then convert to hex for use in the command.

XYYY YYYY

X = 0 – Sync trunk group specified in YYY | YYYY

X = 1 – Sync all trunk groups.

YYY | YYYY = 0 – 127 – Trunk group to sync.

Network Status Byte:

The following network status bytes are returned by the \$30 02 Command:

Status Byte	Meaning
\$01	Command processing accepted. Indicates command sent to the system has passed initial processing. Returned only when Return All is specified in the command's Network Control byte. No corrective action required.
\$D0	Invalid Trunk Group ID.
\$41	Invalid host message length.

6.5.3 SS7 Network Message Generation (\$49) Command (Standard)

Command Type: Resource Control

Description:

The SS7 \$49 Command is used for all call control functions for an SS7 call, including connecting an incoming and outgoing port, and forcing SS7 call origination. Non-SS7 network interface ports can also be controlled with this command in an interworking scenario. The \$49 Command functions as follows:

Set Disconnect Control – Each SS7 \$49 Command for an SS7 controlled port sets the Disconnect Control values. Therefore the command must specify the desired Disconnect Control values. This allows it to be changed after a call has been established.

Create Call – To allocate an internal call object for maintaining connection relationships and take the SS7 controlled port(s) off-hook, you must set the Switching and Attaching bits in the Connection Control byte in the first SS7 \$49 for the call.

Release Call – To deallocate the internal call object and put the SS7 controlled port(s) on-hook, you must set the Switching bit in the Connection Control byte of the \$49 Command releasing the call. Do not set the Attaching bit.

Associate Ports – To make the system consider the Disconnect Control values in a \$49 Command for a non-SS7 controlled port, associate the port with an SS7 controlled port in the call object. You can do this at anytime by providing the non-SS7 port as the other Port Address, either Controlling or Associated.

Send TUP Message – Set the Template Control byte or the TUP Message Type byte to send a TUP message through the Associated Port Address.

- If both the Controlling and Associated Port Addresses are not SS7 controlled or not specified, then network status byte \$03 is returned.
- If the TUP Message Type byte is zero (0), then no TUP message is sent.

Usage Guidelines:

To use the SS7 \$49 Command to generate a TUP message, the destination VCA must be set to \$C1 and byte offset 7 (TUP Message Type) must be set for the message type.

Use this command for SS7 call control functions, including connecting an incoming and outgoing port, and forcing SS7 call origination. Control over the contents of SS7-generated messages is provided.

Total command length cannot exceed 306 bytes.

The controlling port is specified by port address.

A virtual port is not required to originate an outgoing call. Set the Control Address ID to 0, if you want the Controlling Port Address to be used by the host for tracking purposes.

You can choose the associated (outgoing) port two ways: specify by port address or hunt through a resource group.

The returned command is truncated to report only through byte offset 14 (Associated Address I.D.).

In interworking scenarios, either the controlling or associated port can be a non-SS7 port.

If you specify parameters, their values must be coded as they would appear in an SS7 message. Parameters you specify in the command are included in the next SS7 message transmission. The host-specified parameters are added to any SS7 parameters included in the template being executed.

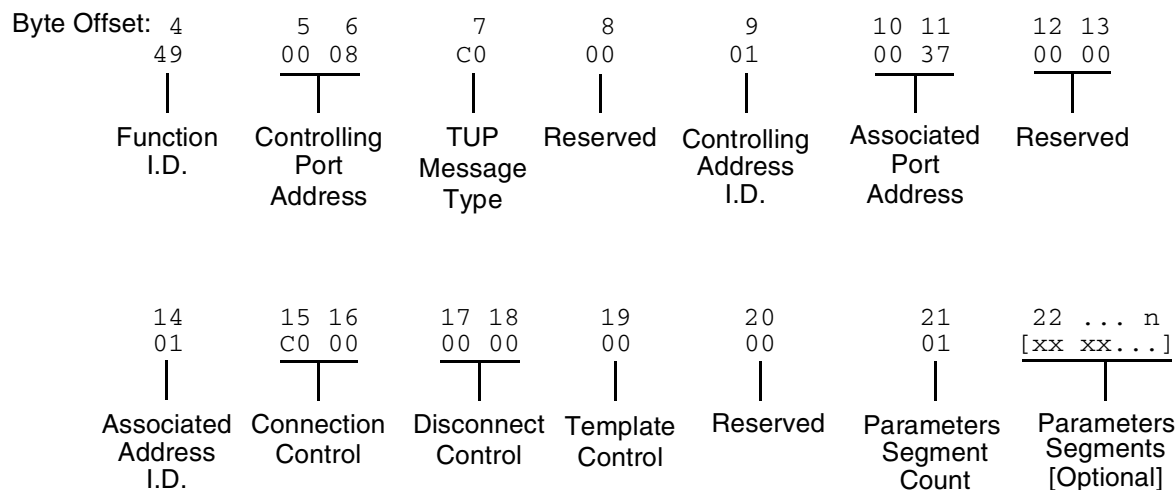
Format:

Function ID (byte offset 4) – Byte immediately following the Network Header; uniquely identifies the command to Circuit Interworking.

Controlling Port Address (byte offset 5 and 6) – Hex representation of the controlling port circuit address for which the command is sent.

TUP Message Type (byte offset 7) – The TUP messages to generate only if the Template Control byte (byte offset 19) is set to zero.

Reserved (byte offset 8) – Always 00

Controlling Address Identifier (byte offset 9) – Specify the byte according to the following:

00 – no controlling address used in command. Controlling Port Address may be used by the host for tracking purposes. (To initiate outbound SS7 calls, set to 00.)

01 – controlling port specified by port address

Associated Port Address (byte offsets 10 and 11) – Hex representation of the associated (outgoing) port circuit address for which the command is sent or the resource group number from which to select the outgoing port. The Associated Address Identifier (byte offset 14) must be set to \$01.

Reserved (byte offsets 12 and 13) – These bytes must be set to \$00 00.

Associated Address Identifier (byte offset 14) – Specifies that the associated (outgoing) port is identified by port address/resource group. Specify the byte according to the list below:

00 – no associated address used in command

01 – associated port specified by port address, or resource group number

Connection Control (byte offsets 15 and 16) – Specifies the switching, attaching, and hunting options when this command is used to connect a call. Byte offset 16 is reserved for future enhancements and must be set to \$00. Construct byte offset 15 according to the descriptions below, then convert to hex for use in the command.

SAPVV000

S – Specifies if switching action is required

S = 0 – no switching action required; A bit ignored and should set to 0

S = 1 – switching action required

A—Specifies whether to link or remove a resource

A = 0 – if S = 1, remove resource from call; if S = 0, no meaning

A = 1 – if S = 1, link resource to call; if S = 0, no meaning

P – Specifies whether to use a specific outgoing circuit or to select any outgoing circuit from a resource group; port address or group number is specified in Associated Port Address bytes

P = 0 – for S = 0 or 1, use port specified in Associated Port Address bytes

P = 1 – for S = 1, select port from resource group specified in Associated Port Address bytes; the port address of the selected channel is specified in the command returned to the host

VV – Not used for SS7. Set to 00.

Disconnect Control Bytes

The Disconnect Control bytes are always included in the command. You can only define byte offset 17 at this time. Byte offset 17 specifies the disposition of ports when the call is torn down. Byte offset 18 is reserved for future enhancements and should be set to \$00.

Bit settings in this byte are overridden if another \$49 Command is processed for either port in this \$49 Command.

Disconnect Control (byte offset 17 & 18) – Determines what actions to take on a port when the opposite end goes on hook. Construct byte in binary according to the descriptions below, then convert to hex for use in the command.

000010U0

I – Specifies whether to return the incoming port to CP_SETUP state when the outgoing port goes on hook

I = 0 – force incoming to idle

I = 1 – set incoming to setup state upon outgoing disconnect; T must be 0

U – Specifies whether to return the outgoing port to CP_SETUP state when the incoming port goes on hook

U = 0 – force outgoing to idle

U = 1 – set outgoing to setup state upon incoming disconnect; C must be 0

Template Control Byte

The Template Control byte is always included in the command, and specifies the template to be used when transmitting an SS7 message.

Template Control (byte offset 19) – Specifies whether a template is to be used in this command and the template number, if any (see *Section 6.2*). Construct byte in binary according to the descriptions that follow, then convert to hex for use in the command.

XORRRRRR

X – Specifies if an template is used in this command

X = 0 – no template specified. Use TUP Message Type byte (offset byte 7).

X = 1 – execute template specified in RRRRRR; I must be 0

RRRRRR – Specifies the template number.

Reserved (byte offset 20) – Always 00.

Parameter Segment Count Byte

The Parameter Segment Count byte is used in all \$49 Commands and specifies how many parameters are included in the command.

Parameter Segment Count (byte offset 21) – Specifies how many parameters are included in the command. Convert from decimal to hex for use in the command. A value of \$00 indicates that no parameters follow this byte.

Parameter Segment

The Parameter Segment bytes contain parameters to be transmitted to the SS7 network. The number of parameters contained in this segment appears in the Parameter Segment Count byte.

NOTE: Each time a \$49 command is sent, the parameters defined in that particular command override any permanent parameters set in the template it names in byte offset 19.

Each parameter consists of a Parameter Code byte, a Parameter Data Length byte, and one or more Parameter Data bytes. The format and components of the Parameter Segment are defined as follows:

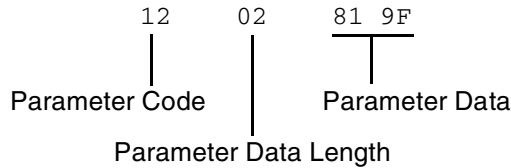

Parameter Code – Specifies the parameter code.

Parameter Data Length – Specifies the number of parameter data bytes.

Parameter Data – Specifies the parameter data exactly as it should be sent to the SS7 network.

Special Parameter Formats

The following TUP parameter formats in the SS7 \$49 command deviate from the formats specified in the China TUP protocol signaling specification document. All other parameters follow the protocol formats.

Calling Line Identity Parameter

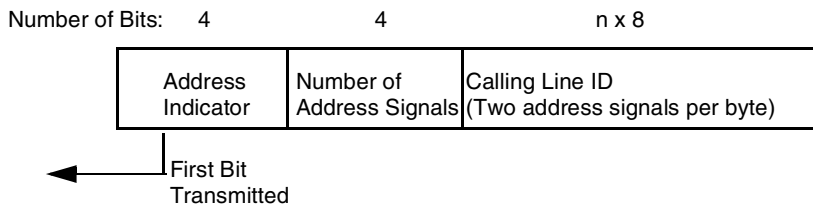

Figure 6.7: Typical Calling Line Identity Parameter Format (per protocol spec)

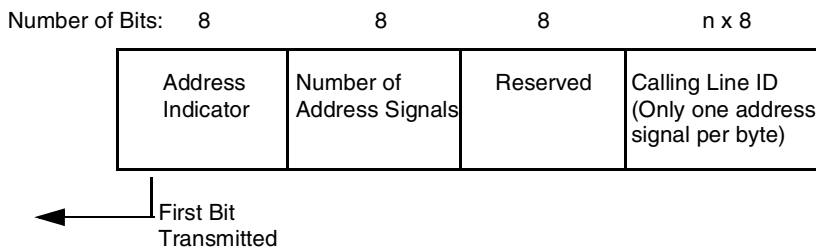

Figure 6.8: SS7 \$49 Command Calling Line Identity Parameter Format

Example

The calling party number is 0273321119.

According to the protocol, the parameter would be coded as follows:

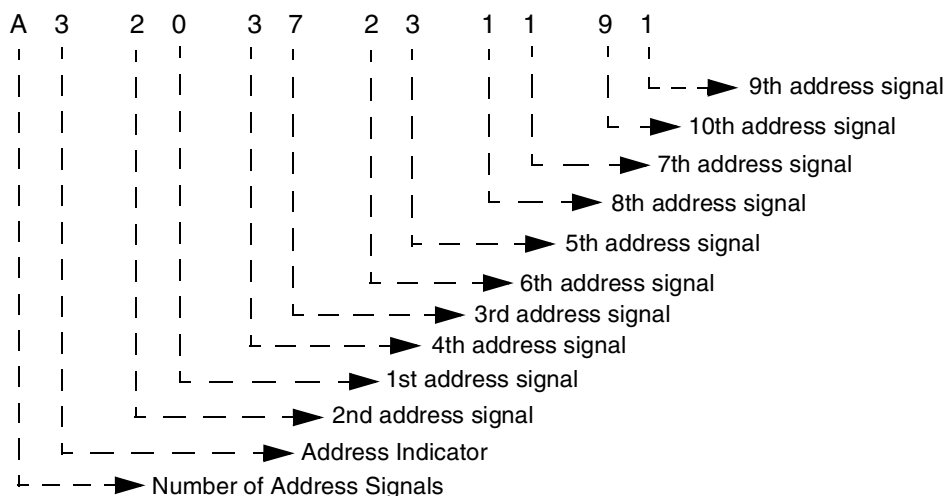

Figure 6.9: Sample Calling Line Identity Parameter Per Protocol Coding

For the SS7 \$49 Command, however, the parameter needs to be coded as shown below:

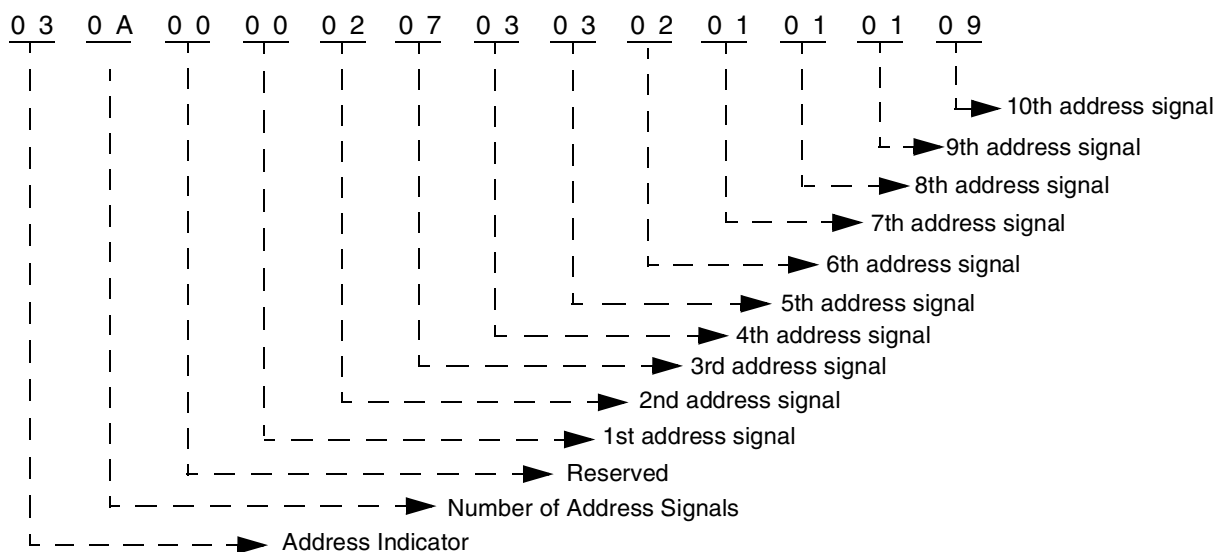

Figure 6.10: Sample Calling Line Identity Parameter Coding for SS7 \$49 Command

Original Called Address Parameter

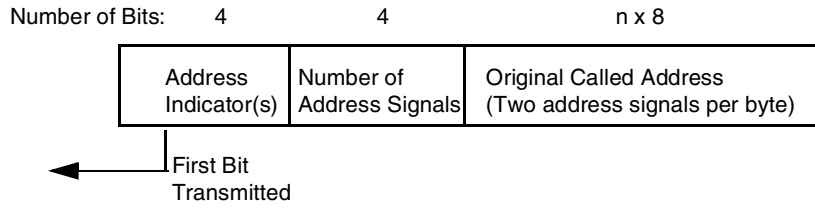

Figure 6.11: Typical Original Called Address Parameter Format (per protocol spec)

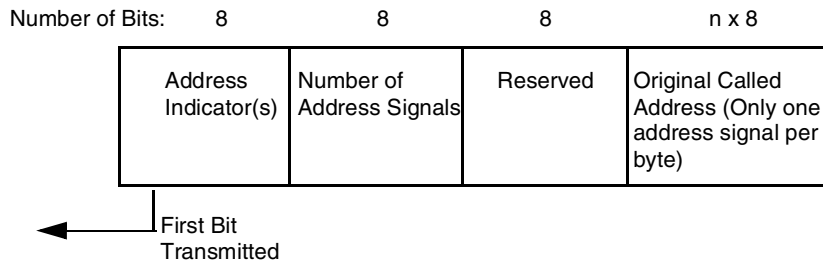

Figure 6.12: SS7 \$49 Command Original Called Address Parameter Format

Example

The called party number is 0273321119.

According to the protocol, the parameter would be coded as follows:

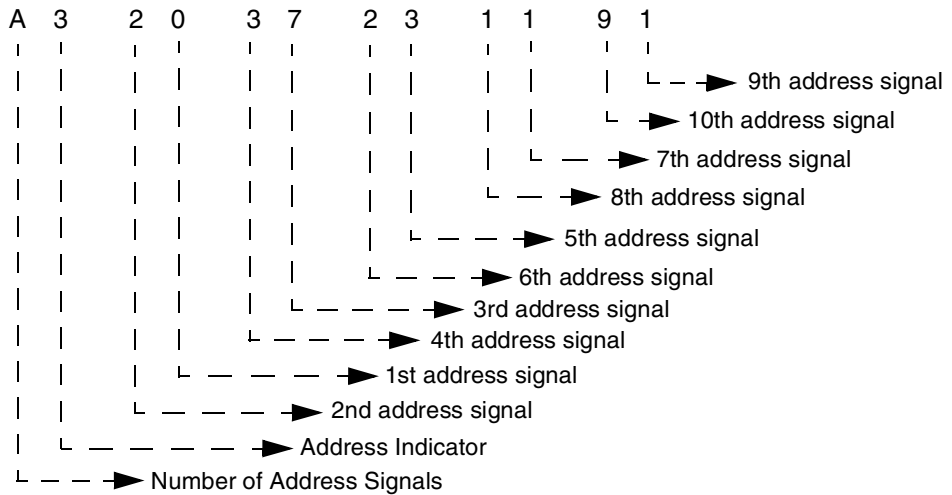

Figure 6.13: Sample Called Address Parameter Per Protocol Coding

For the SS7 \$49 Command, however, the parameter needs to be coded as shown below:

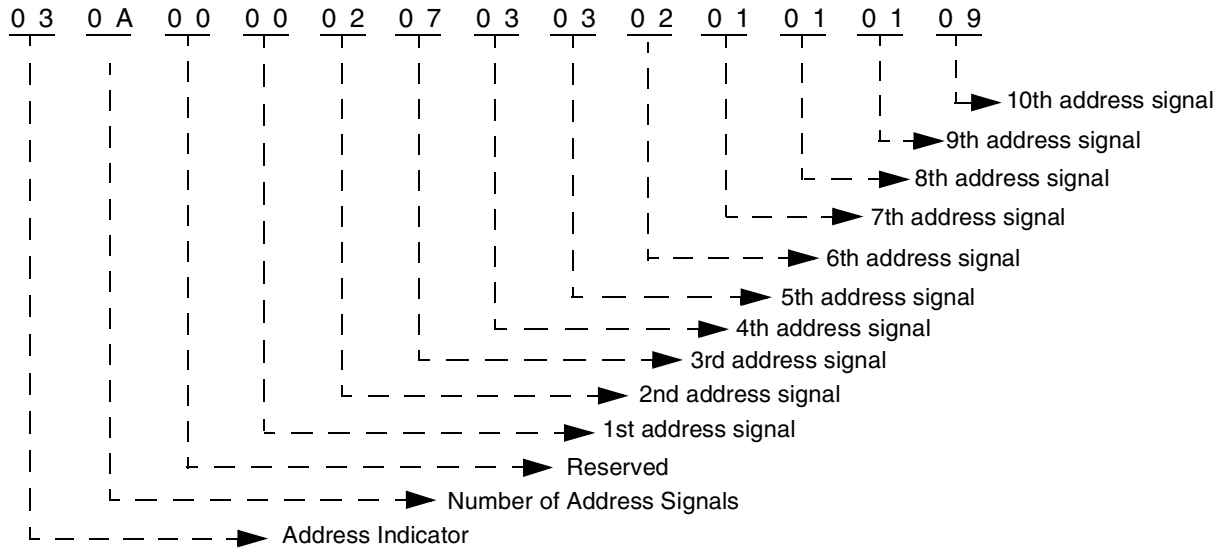

Figure 6.14: Sample Called Address Parameter Coding for SS7 \$49 Command

Incoming Trunk and Transit Exchange ID Parameter

NOTE: The Incoming Trunk and Transit Exchange ID parameter does not currently support a Signaling Point Code for the Identity Type Indicator.

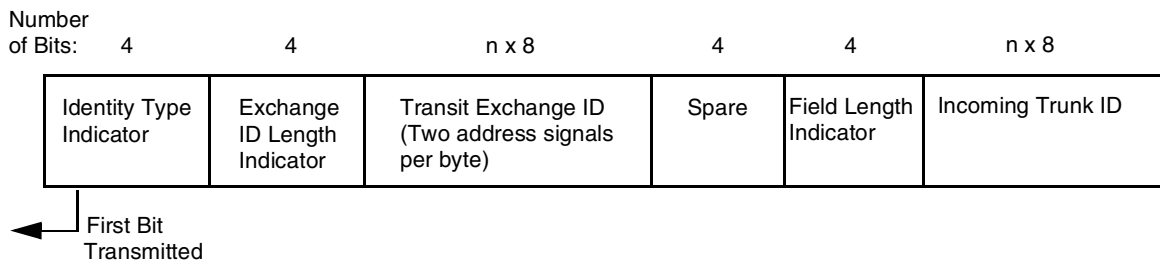

Figure 6.15: Typical Incoming Trunk and Transit Exchange ID Parameter Format (per protocol spec)

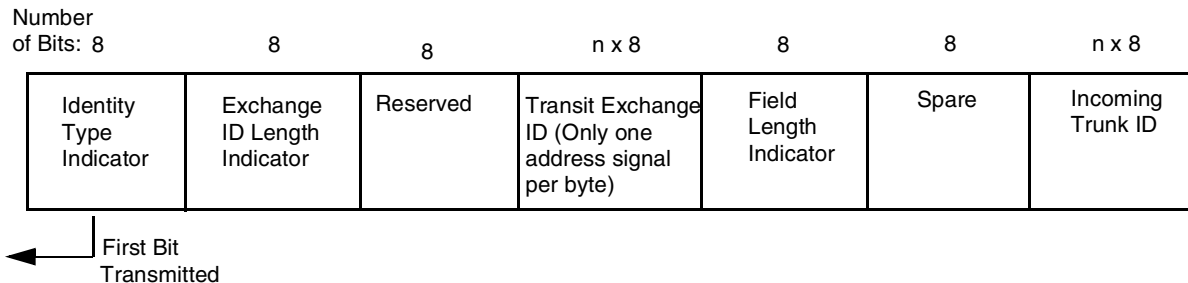

Figure 6.16: SS7 \$49 Command Incoming Trunk and Transit Exchange ID Parameter Format

Example

The calling party number is 0273321119.

According to the protocol, the parameter would be coded as follows:

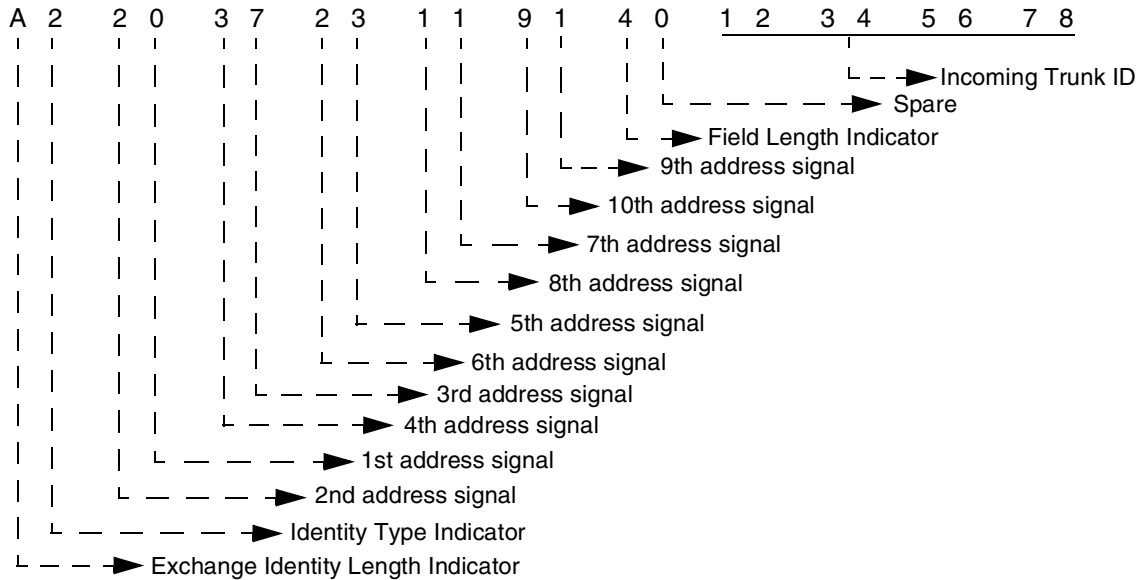

Figure 6.17: Sample Incoming Trunk and Transit Exchange ID Parameter Per Protocol Coding

For the SS7 \$49 Command, however, the parameter needs to be coded as shown below:

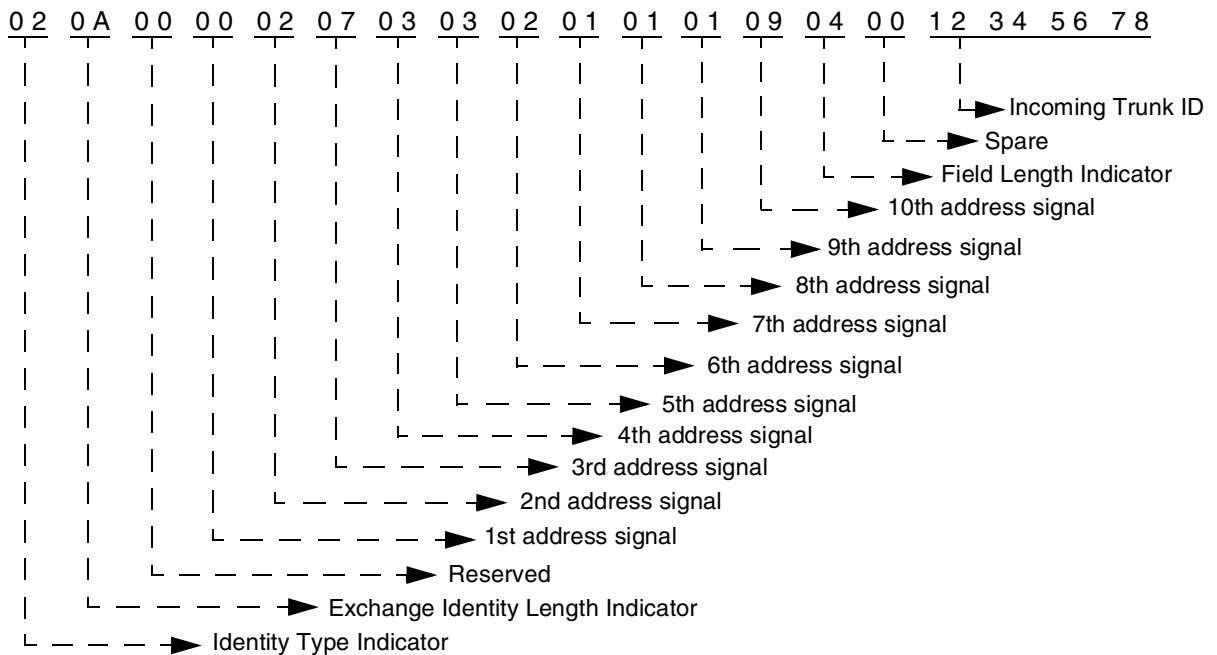

Figure 6.18: Sample Incoming Trunk and Transit Exchange ID Parameter Coding for SS7 \$49 Command

Network Status Byte:

The following network status bytes are returned by the \$49 Command:

Status Byte	Meaning
\$01	Command processing accepted. Indicates command sent to the system has passed initial processing. Returned only when Return All is specified in the command's Network Control byte. No corrective action required.
\$03	Syntax error in command. Indicates one or more of the values specified in the command are invalid or that the command specifies no action or improper switching actions within the SAP bit settings. Specifying values in spacer bytes or reserved bytes may also cause syntax errors. Check all byte values in command.
\$08	Command received was received by Standby side but can only be processed on the Active side.
\$0D	Invalid resource group number. The resource group specified in the command is 0 or greater than 63. Check resource group number.
\$0E	Invalid controlling port address (not in valid range). The port address specified in the command is not within the range of system port addresses or that port address is not assigned. Check port address.
\$0F	Invalid controlling host
\$15	Invalid associated port address (not in valid range). Indicates the port address specified in the command is not within the range of system port addresses. Check port address or select a port from appropriate resource group.
\$2B	The Template number specified in the command is out of the range for a rule (1 to 32). Check value and resend command with correct value.
\$41	Invalid host message length
\$C7	Invalid range specified in group maintenance messages.
\$C8	Incoming port is in the wrong state.
\$C9	No resource available.
\$CA	Outgoing port is in the wrong state.
\$CB	Parameter error in the host command.
\$CC	Parameter error in the template file.

Status Byte	Meaning
\$CD	Invalid TUP message type.
\$CE	Missing Range and Status parameter.
\$CF	Protocol violation. This network status byte usually indicates that the TUP message type is invalid for the current call state.
\$D1	The Far End SP is unavailable.

6.5.4 SS7 Host Call Load Control (\$C0 04) Command (Standard)

Command Type: Configuration Control

Description:

Used in conjunction with the Host Control of Call Load feature in the Generic software (refer to the System Host Configuration screen in the *System Administrator's Guide*). When the feature is enabled, this command allows the host to indicate its ability to process all calls, existing calls only, or no calls.

Usage Guidelines:

The system verifies that the Host Control of Call Load feature has been enabled before processing the command. If the feature is not enabled in the Generic software, the command is returned with a network status byte of \$1B (feature not enabled) in the network header.

If the load control code is set to 00, normal call processing occurs with no restrictions.

If the load control code is set to 01, cktint does not send SS7 \$EA reports to the host or process SS7 \$49 commands containing call control messages from the host until the host sends an SS7 \$C0 04 command indicating that it is ready to process calls. All maintenance reports are still sent to the host; all maintenance message commands are also sent and processed.

In addition, if the load control code is set to 02, cktint does not send new call reports to the host or process commands containing IAM messages from the host until the host indicates that it is ready to process new calls. However, commands will still be accepted from and reports sent to the host for calls in progress.

You can use the SS7 \$C0 04 command various ways. For example, sending an SS7 \$C0 04 command with the load control code set to 01 would allow the host to perform some type of initialization before accepting calls (the default setting on startup when the Host Control of Call Load feature is enabled). With the load control code set to 02, current calls will be completed, but no new calls accepted—a “graceful shutdown.”

This command only affects operations with respect to the host from which it is received. If there are multiple hosts, the command must be sent by each host.

NOTE: On an SS7 system, the \$C0 04 command destination VCA must be set to \$C1; otherwise, this could result in tcp link state mismatches between the VCO/4K, cktint, and the host.

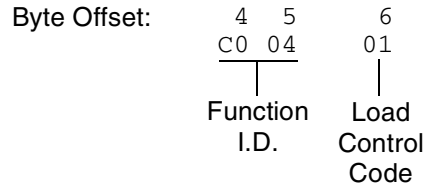
Format:

Function ID (byte offset 4 and 5) – Byte immediately following the Network Header. The Function ID uniquely identifies the command to the Integrated SS7 system.

Load Control Code (byte offset 6) – Determines whether the system should process incoming calls by reporting them to the host or reject call control commands sent by the host. Specify this byte according to the following list:

00 = Normal call processing

01 = Call processing suspended

02 = No new calls accepted or sent from the host; process existing calls only

Network Status Byte:

The following network status bytes are returned by the SS7 \$C0 04 Command:

Status Byte	Meaning
\$01	Command processing accepted. Indicates command sent to the system has passed initial processing. Returned only when Return All is specified in the command's Network Control byte. No corrective action required.
\$03	Syntax error in command.
\$1B	Host Control of Call Load feature is not enabled and command was not processed.
\$D2	VCO/4K is not connected and command was not processed.

Host Link States:

The following table summarizes possible Host Link States associated with the SS7 \$C0 04 Command:

Host Link State	Affect on Messaging
ONLINE_READY	Normal messaging. All host commands and reports allowed. Set by SS7 \$C0 04 host command with the load control code set to 00.
ONLINE_NOT_READY	<p>Call processing effectively suspended; all call control commands rejected.</p> <ul style="list-style-type: none"> • No new SS7 \$EA call reports sent. • No call control commands allowed; only configuration commands (i.e., \$C0 04, \$C0 01, \$30 01, \$30 02) and maintenance messages. <p>Set by SS7 \$C0 04 host command with the load control code set to 01.</p>
ONLINE_RESTRICTED	<p>Processing of calls in progress; host commands accepted.</p> <ul style="list-style-type: none"> • No SS7 \$EA report for new call reports for incoming IAM. • All host commands allowed, except SS7 \$49 command with IAM. <p>Set by SS7 \$C0 04 host command with the load control code set to 02.</p>

NOTE: If calls are present when the host goes ONLINE_NOT_READY, there can be a mismatch of circuit states among the VCO/4K, cktint, and the host.

When the Host Control of Call Load feature is enabled and there is a connection to the host, the initial tcp link state in cktint is ONLINE_NOT_READY. It stays in this state until receiving an SS7 \$C0 04 command from the host requesting a host link state change.

6.5.5 SS7 Host Assume/Relinquish Port Control (\$C0 05) Command (Standard)

Command Type: Configuration Control

Description:

Allows a host process to relinquish control of a call assigned to itself, or assume control of a call that has been assigned to a different host.

Usage Guidelines:

This command performs the assume/relinquish port control function. A function code allows a host link to override a controlling host assignment with one of two operating modes: one mode allows a host to assume control of a port; the other mode allows a host to relinquish control of a port. In either case, the assignment override remains in effect as long as the affected port is involved in a call, or until a subsequent override command is received. The relinquish mode clears the controlling host assignment for the specified port so that another host can take control of that port.

Format:

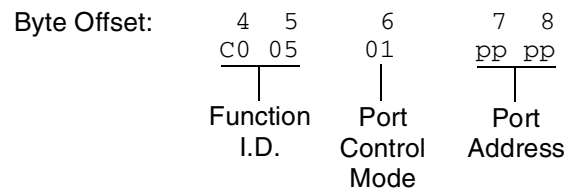

Function ID (byte offset 4 and 5) – Byte immediately following the Network Header. The Function ID uniquely identifies the command to the Integrated SS7 system.

Port Control Mode (byte offset 6) – Determines the type of action to be taken. Specify this byte according to the following list:

00 = Relinquish control

01 = Assume control

Port Address (byte offsets 7 and 8) – Port address for which control is being seized or relinquished.

Network Status Byte:

The following network status bytes are returned by the \$C0 05 Command:

Status Byte	Meaning
\$01	Command processing accepted. Indicates command sent to the system has passed initial processing. Returned only when Return All is specified in the command's Network Control byte. No corrective action required.
\$03	Syntax error in command. Indicates one or more of the values specified in the command are invalid or that the command specifies no action or improper switching actions within the SAP bit settings. Specifying values in spacer bytes or reserved bytes may also cause syntax errors. Check all byte values in command.
\$0E	Invalid controlling port address (not in valid range). Indicates the port address specified in the command is not within the range of system port addresses or that port address is not assigned. Check port address.
\$C9	No resource available.

6.5.6 SS7 Circuit Status (\$B0 01) Report (Standard)

Report Type: System Status

Description:

Reports the SS7 circuit states for a trunk group.

Action Causing Report Generation:

Generated in direct response to an SS7 Circuit Query (\$30 01) Command. If all trunk groups were requested, then multiple reports are generated, one for each trunk group.

Format:

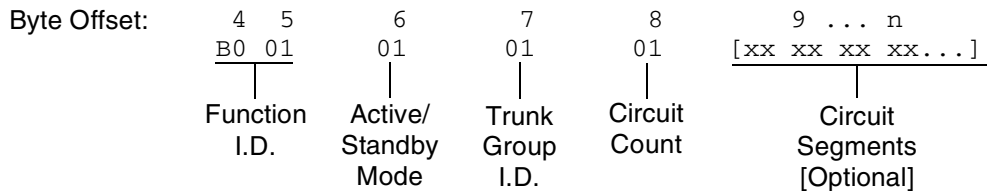

Main Command Segment

Function ID (byte offsets 4 and 5) – Bytes immediately following the Network Header; uniquely identifies this report from Circuit Interworking.

Active/Standby Mode (byte offset 6) – Indicates active/standby mode. Non-redundant systems will always return active mode.

0 = Standby mode

1 = Active mode

Trunk Group ID (byte offset 7) – Specifies the trunk group.

Circuit Count (byte offset 8) – Indicates the number of circuit segments that follow. This will be a value from 0 to 32.

Circuit Segments

Circuit Segments (byte offset 9 – n) – Each segment consists of four bytes. They are the Circuit Port Address (2 bytes), the Circuit State/Call State (1 byte), and the Circuit Sub State (1 byte). The number of circuit segments is specified by the Circuit Count.

Circuit Port Address – The VCO/4K port address associated with this circuit.

Circuit State/Call State — The (maintenance) state of this circuit. The possible hex values are as follows:

FF	Unknown
00	Unequipped
01	Transient
10	Unequipped/Idle
12	Active/Idle
13	Remotely Blocked/Idle
14	Locally Blocked/Idle
15	Locally and Remotely Blocked/Idle
22	Active/Incoming Busy
23	Remotely Blocked/Incoming Busy
24	Locally Blocked/Incoming Busy
25	Locally and Remotely Blocked/Incoming Busy
32	Active/Outgoing Busy
33	Remotely Blocked/Outgoing Busy
34	Locally Blocked/Outgoing Busy
35	Locally and Remotely Blocked/Outgoing Busy

Circuit Sub State — The call state of this circuit. The possible hex values are as follows:

00	Idle
01	Delivered
02	Present
03	Answered
04	Released
05	Received
06	Initiated
07	Continuity
08	Reserved
09	Continuity Reserved
0A	Continuity Present
0B	Continuity Initiated
0C	Continuity Initiated Detected
0D	Continuity Initiated End
0E	Continuity End
0F	Continuity Previous Call Present
10	Continuity Previously Initiated

- 11 **Locally Suspended**
- 12 **Remotely Suspended**
- 13 **Local and Remote Suspended**

6.5.7 SS7 System Port Status (\$D3) Report (Standard)

Report Type: System Status

Description:

Informs the host of an attempted change in the status of a system resource port. Change can be the result of:

- Activating/deactivating a port or card span (refer to the *System Administrator's Guide*)
- Transmission or reception of an SS7 TUP Maintenance message

Action Causing Report Generation:

This report is generated when a change occurs in the operating status of an individual SS7 circuit. Status changes can be caused by an action at the system administrative console (isup_console), a host command, or a received SS7 TUP maintenance message.

A report indicating a port's availability may be returned from a circuit in Active mode. When a circuit is Out-of-Service, no other \$D3 reports are generated for that port.

Format:

Byte Offset:	4	5	6 7	8	9	10 11 12
	D3	13	00 18	02	03	00 00 00
	Function	Old	Port	Originator	Resource	Reserved
	I.D.	Status/ New	Address		Group	
		Status				

Function I.D. (byte offset 4) – Byte immediately following the Network Header; uniquely identifies the report from the system.

Old Status/New Status (byte offset 5) – Specifies the status of the port before the change occurred and the present status of the port. Convert byte from hex to binary and interpret the bits as described on the following page.

MMMMNNNN

MMMM – specifies the status of the port before the change occurred

MMMM = 0001 – resource was unavailable (Out of Service)

MMMM = 0011 – resource was on line and available

NNNN – specifies the current status of the port

NNNN = 0001 – resource is currently unavailable (Out of Service)

NNNN = 0011 – resource currently on line and available

Port Address (byte offsets 6 and 7) – Hex representation of port address for which the report is generated.

Originator (byte offset 8) – Specifies whether the change in status was originated by the system or the host and the reason for the change. The following originator code values are added to the CktInt \$D3 reports sent to the host during SS7 events:

- 01 – A circuit group block (MGB/HGB) or a block (BLO) message was received from the SS7 network (SS7_BLOCKING event).
- 02 – A circuit group unblock (MGU/HGU) or a unblock (UBL) message was received from the SS7 network (SS7_UNBLOCKING event).
- 03 – A circuit group unblock acknowledge (MUA/HUA) or a unblock acknowledge (UBA) message was received from the SS7 network (SS7_UNBLOCKING_ACK event).
- 04 – A reset circuit (RSC), circuit group reset (GRS), release guard (RLG), or circuit group reset acknowledge (GRA) message was received from the SS7 network (SS7_RESET event).
- 05 – A change of port status from OFFLINE to ONLINE was received from the VCO/4K in the form of \$D9 or \$D3 reports (SDS_UNBLOCK event).
- 06 – A change of port status to OFFLINE was received from the VCO/4K in the form of \$D9 or \$D3 reports (SDS_BLOCK event).
- 07 – The user initiated a circuit group unblock (MGU/HGU) or unblock (UBL) message either through isup_console or through a host message (MAINT_UNBLOCK event).
- 08 – The user initiated a circuit group block (MGB/HGB) or block (BLO) message either through isup_console or through a host message (MAINT_BLOCK event).
- 09 – A circuit group reset (GRS) or reset circuit (RSC) was initiated by the host or a user through isup_console.

Resource Group (byte offset 9) – specifies the resource group number to which the port belongs; convert byte from hex to decimal for the group number (1 to 32 inclusive).

Reserved (byte offsets 10 to 12) – These bytes must be set to 00 00 00.

6.5.8 SS7 Circuit Group Status (\$D9) Report (Standard)

Report Type: Circuit Group Status

Description:

Informs the host of a change in the state of a circuit group.

Action Causing Report Generation:

Generated when cktint receives an incoming MGB/HGB/MGU/HGU/GRS from the network, system, or isup_console.

Format:

Byte Offset:	4	5	6	7	8	9	10	11	12	13	14
	D9	00	20	00	27	05	00	00	00	01	00
	Function	Lowest	Highest	Originator	Reserved	Ports'	Reserved				
	I.D.	Port	Port			Status					
		Address	Address								

Function I.D. (byte offset 4)—Byte immediately following the Network Header; uniquely identifies the report from Circuit Interworking system.

Lowest Port Address (byte offsets 5 and 6)—Hex representation of the first port address of the circuit group for which the report is sent.

Highest Port Address (byte offsets 7 and 8)—Hex representation of the last port address on the card for which the report is sent.

Originator (byte offset 9)—Specifies whether the MGB/HGB/MGU/HGU/GRS message was originated by the system, host, or isup_console. The following originator code values are added to the CktInt \$D9 reports sent to the host during SS7 events:

- 01 – A circuit group block (MGB/HGB) message was received from the SS7 network
- 02 – A circuit group unblock (MGU/HGU) message was received from the SS7 network
- 03 – A circuit group unblock acknowledge (MUA/HUA) message was received from the SS7 network
- 04 – A circuit group reset (GRS) message was received from the SS7 network
- 05 – A circuit group reset acknowledge (GRA) message was received from the SS7 network
- 06 – A circuit group block (MGB/HGB) message was sent to the SS7 network (as the result of a \$D9 OOS report from the VCO)
- 07 – A circuit group block (MGB/HGB) message was sent to the SS7 network from the isup_console
- 08 – A circuit group reset (GRS) message was sent to the SS7 network

Reserved (byte offsets 10 to 12)—Always 00 00 00.

Ports' State (byte offset 13)—Indicates the present state of the ports for which the report is generated. Interpret this byte according to the list that follows:

01 – Available

02 – Unavailable

03 – Transient

Reserved (byte offset 14) – Always 00.

6.5.9 SS7 Network Message Reception (\$EA) Report (Standard)

Report Type: Resource Control

Description:

The SS7 \$EA Report informs the host of a change in the state of an SS7 call. A change of state occurs when an SS7 TUP message is received from the SS7 network. Both the affected SS7 controlling and associated ports are represented.

Ports identified in this report are SS7 ports only. Non-SS7 ports are never represented in an SS7 \$EA report. (i.e. ACM received from the network with one SS7 port and one non-SS7 port—only the SS7 port affected by the ACM will be represented in the report.)

This report may be truncated if the network header segment, base report, and parameters exceed 255 bytes in length. No indication of truncation is provided to the host.

Format:

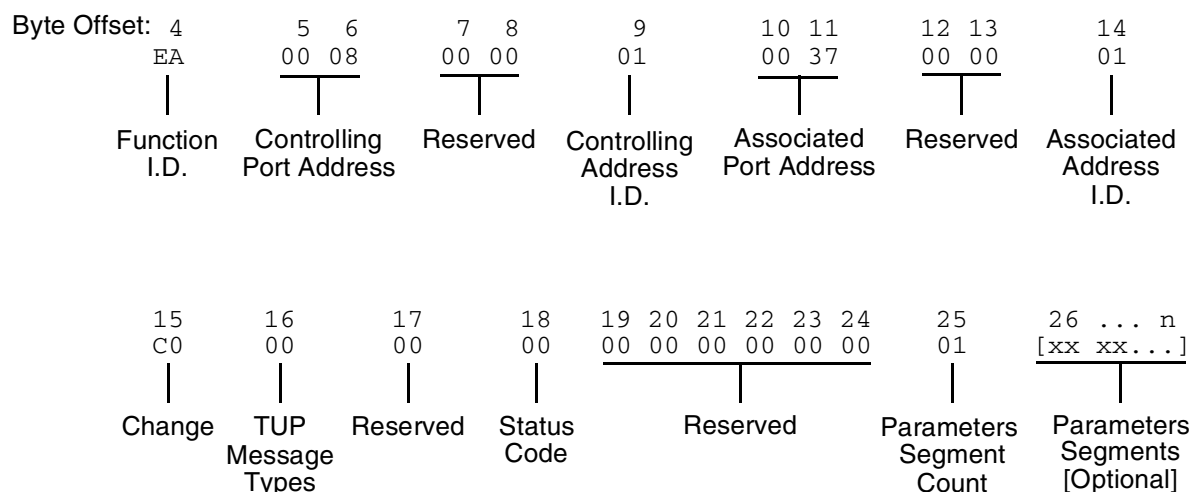

Function I.D. (byte offset 4) – Byte immediately following the Network Header; uniquely identifies the report from Circuit Interworking system.

Controlling Port Address (byte offsets 5 and 6) – Hex representation of the controlling port address for which the report is sent. These bytes represent the specific circuit assigned to the call.

Reserved (byte offsets 7 and 8) – Always 00 00.

Controlling Address Identifier (byte offset 9) – Specifies the controlling port is identified by port address. Interpret the byte according to the list below:

01 — controlling port specified by port address.

Associated Port Address (byte offsets 10 and 11) – Hex representation of the associated (outgoing) port address for which the report is sent. These bytes represent the specific circuit used.

Reserved (byte offsets 12 and 13) – Always 00 00.

Associated Address Identifier (byte offset 14) – Specifies the associated (outgoing) port is identified by port address. Interpret the byte according to the list below:

00 – No associated port

01 – Associated port specified by port address

Change (byte offset 15) – Type of change detected. The list below provides a general indication of the change that occurred for the outgoing port.

00 – No change; report issued to send SS7 message

40 – Port became inactive (RLG, CLF message)

80 – Port became active (IAM or IAI received)

TUP Message Type (byte offset 16) – Indicates the SS7 message received. The message type is the hex value for the message. Refer to *Appendix E* for a list of the TUP messages and their function.

Reserved (byte offset 17) – Always 00.

Status Code (byte offset 18) – Indicates if an error was encountered. Interpret the byte according to the list below:

01 – No error

A4 – Protocol violation

Reserved (byte offset 19) – Always 00.

Reserved (byte offsets 20 to 24) – Always 00 00 00 00 00.

Parameter Segment Count Byte

The Parameter Segment Count byte is used in all \$EA reports and specifies how many parameters are included in the report.

Parameter Segment Count (byte offset 25) – Specifies how many parameters are included in the command. Convert from decimal to hex for use in the command. A value of \$00 indicates that no parameters follow this byte.

Parameter Segment

The Parameter Segment bytes contain parameters to be received from the SS7 network. The number of parameters contained in this segment appears in the Parameter Segment Count byte.

Each parameter consists of a Parameter Code byte, a Parameter Data Length byte, and one or more Parameter Data bytes. The format and components of the Parameter Segment are defined as follows:

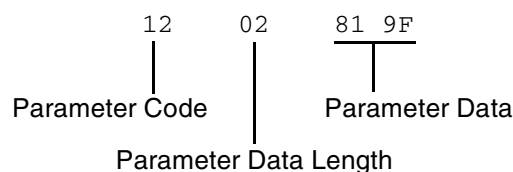

Parameter Code — Specifies the parameter code.

Parameter Data Length — Specifies the number of parameter data bytes; length of 00 indicates no parameter data.

Parameter Data — Specifies the parameter data exactly as it is received from the SS7 network.

Special Parameter Formats

The following TUP parameter formats in the SS7 SEA Report deviate from the formats specified in the China TUP protocol signaling specification document. All other parameters follow the protocol formats.

Calling Line Identity Parameter

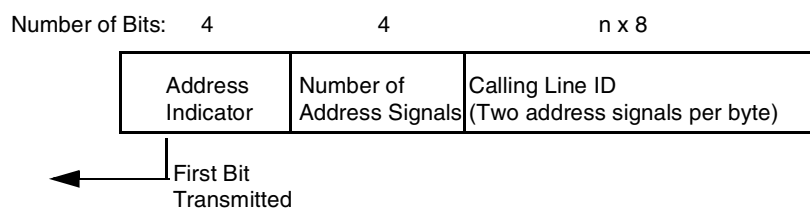

Figure 6.19: Typical Calling Line Identity Parameter Format (per protocol spec)

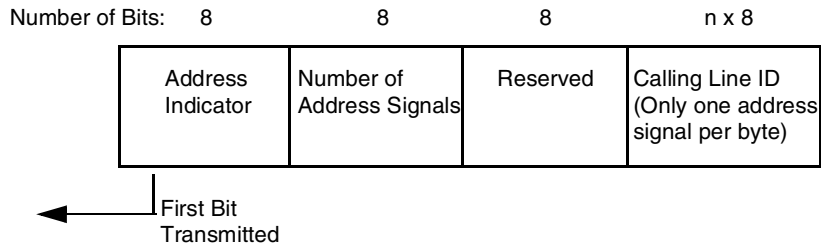

Figure 6.20: SS7 \$EA Report Calling Line Identity Parameter Format

Example

The calling party number is 0273321119.

According to the protocol, the parameter would be coded as follows:

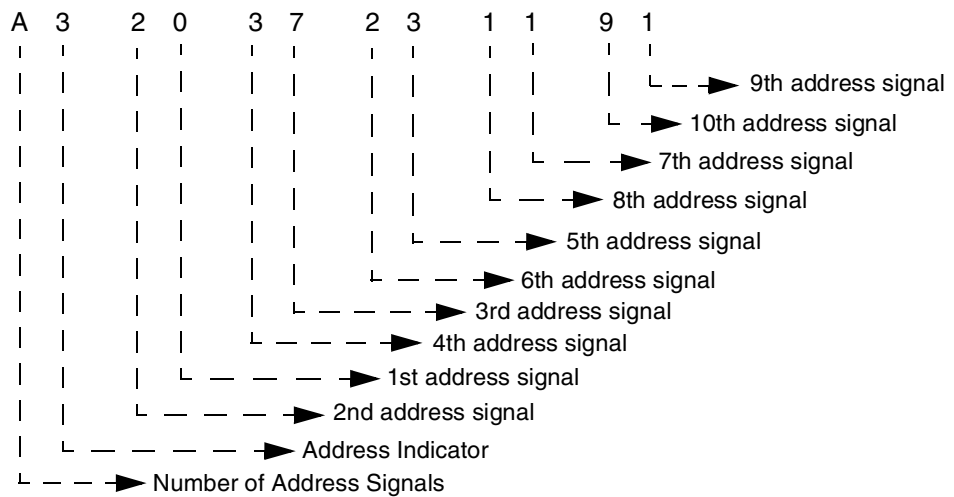

Figure 6.21: Sample Calling Line Identity Parameter Per Protocol Coding

For the SS7 \$EA Report, however, the parameter is coded as shown below:

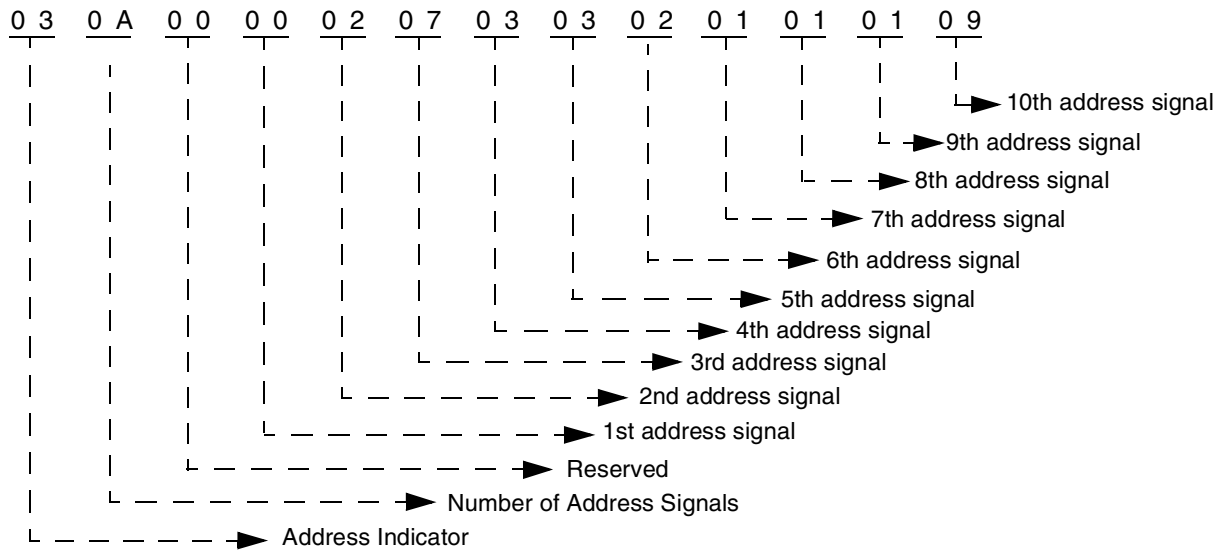

Figure 6.22: Sample Calling Line Identity Parameter Coding for SS7 \$EA Report

Original Called Address Parameter

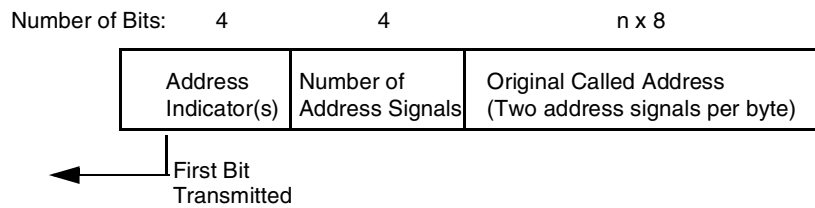

Figure 6.23: Typical Original Called Address Parameter Format (per protocol spec)

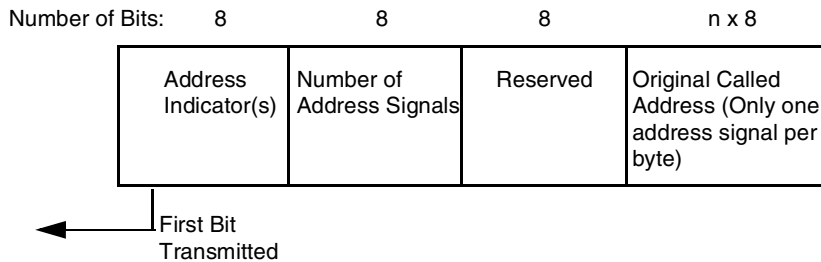

Figure 6.24: SS7 \$EA Report Original Called Address Parameter Format

Example

The called party number is 0273321119.

According to the protocol, the parameter would be coded as follows:

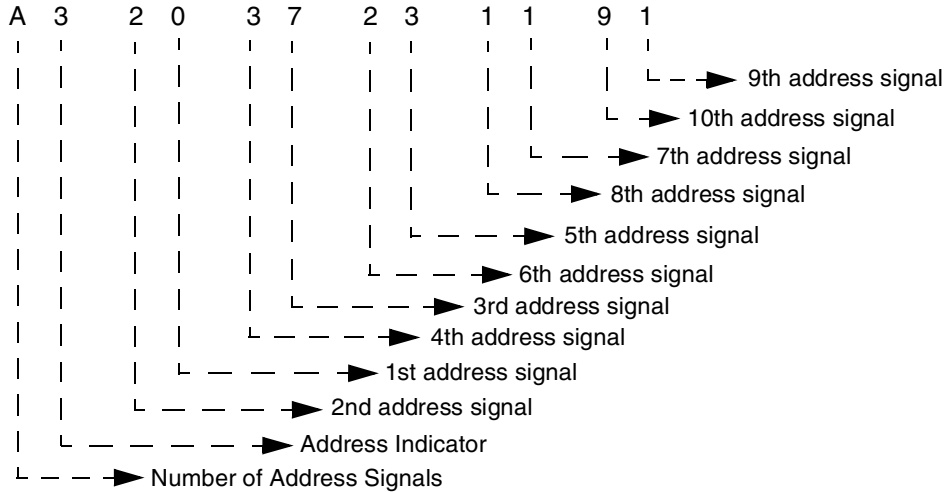

Figure 6.25: Sample Called Address Parameter Per Protocol Coding

For the SS7 \$EA Report, however, the parameter is coded as shown below:

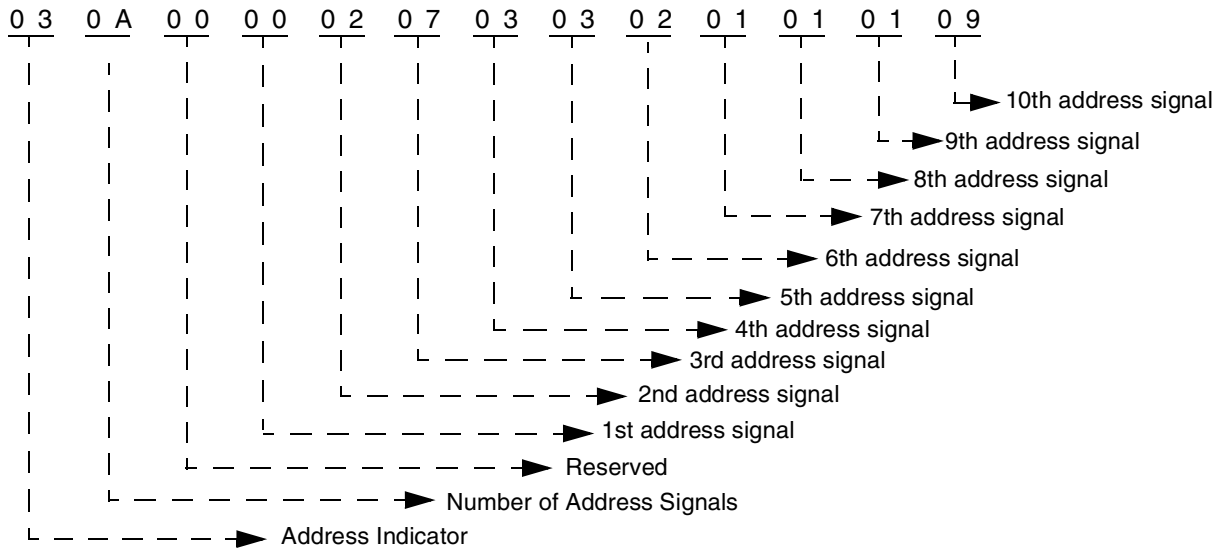

Figure 6.26: Sample Called Address Parameter Coding for SS7 \$EA Report

Incoming Trunk and Transit Exchange ID Parameter

NOTE: The Incoming Trunk and Transit Exchange ID parameter does not currently support a Signaling Point Code for the Identity Type Indicator.

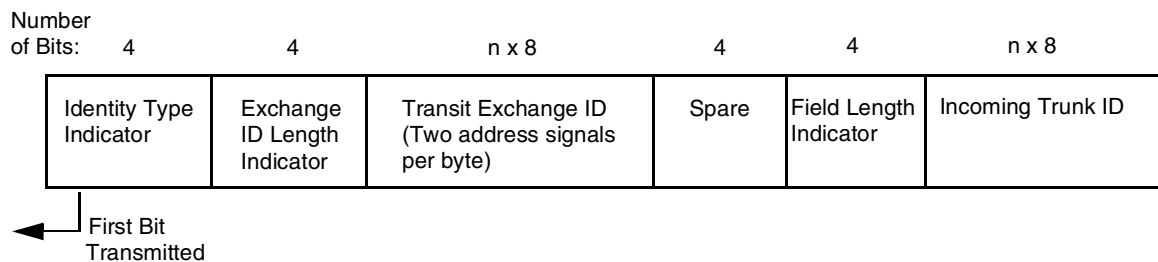

Figure 6.27: Typical Incoming Trunk and Transit Exchange ID Parameter Format (per protocol spec)

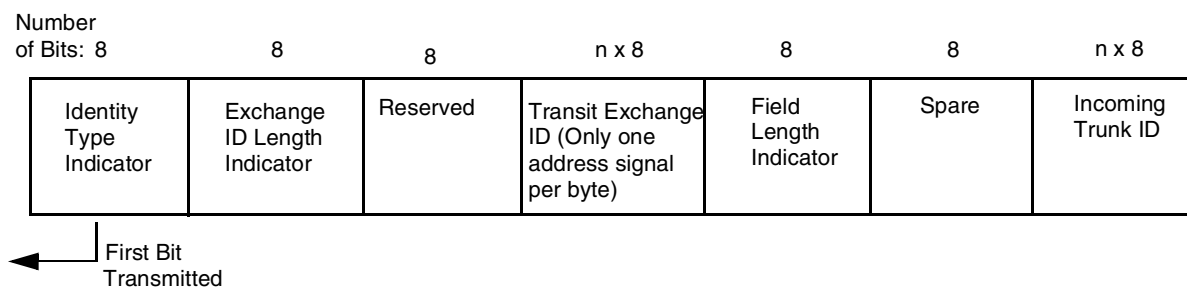

Figure 6.28: SS7 \$EA Report Incoming Trunk and Transit Exchange ID Parameter Format

Example

The calling party number is 0273321119.

According to the protocol, the parameter would be coded as follows:

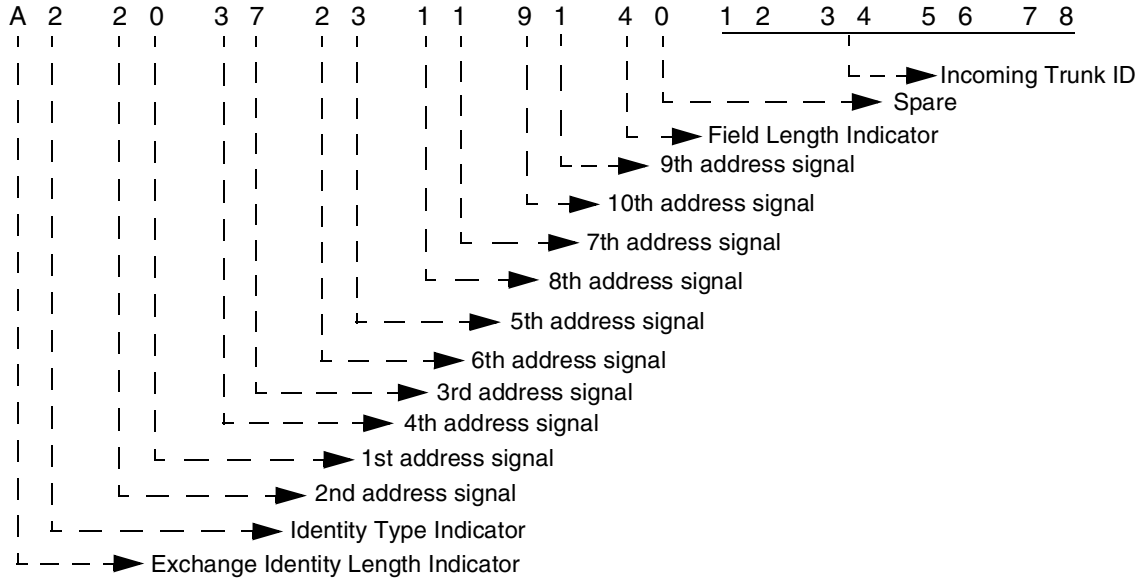

Figure 6.29: Sample Incoming Trunk and Transit Exchange ID Parameter Per Protocol Coding

For the SS7 \$EA Report, however, the parameter is coded as shown below:

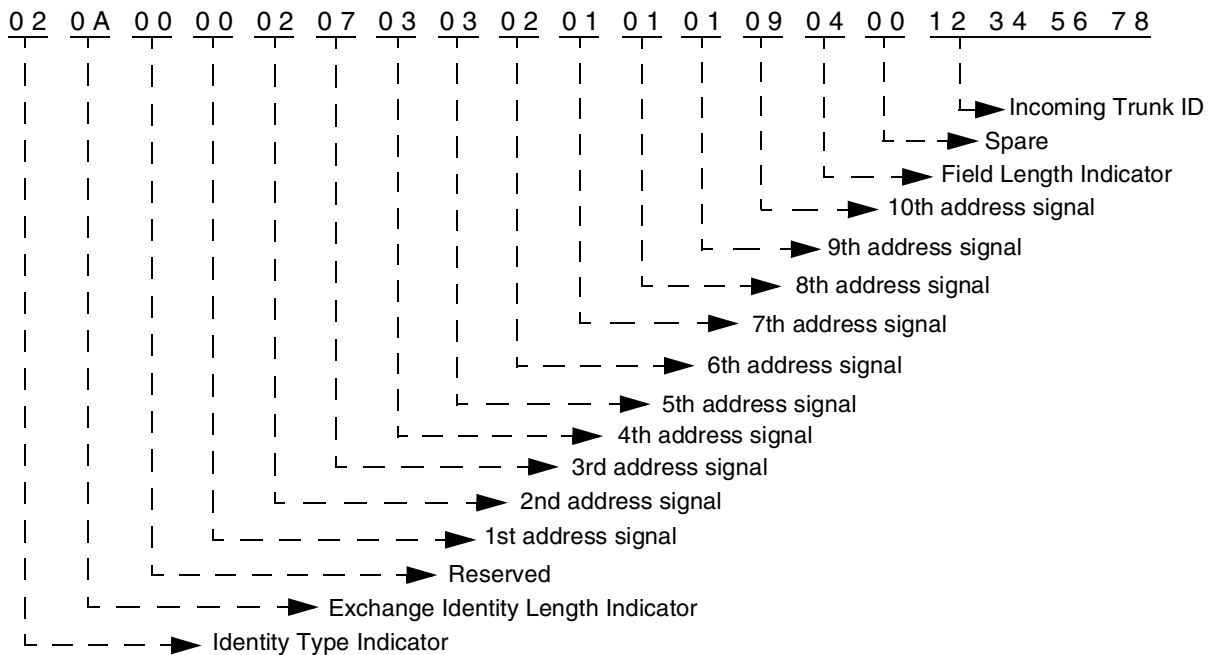

Figure 6.30: Sample Incoming Trunk and Transit Exchange ID Parameter Coding for SS7 \$EA Report

6.5.10 SS7 Alarm Condition (\$F0) Report (Standard)

Report Type: System Status

Description:

Informs the host of the presence of specified system alarms, including alarm severity and type.

The SS7 \$F0 report allows the host the flexibility to take corrective action from a remote facility.

Action Causing Report Generation:

Circuit Interworking generates this report for the host when it detects link alarms—Link Unavailable (880702) or Link Available (880704)—at the MTP level. See the *NewNet AccessManager Maintenance Manual* for more information on specific alarms.

Format:

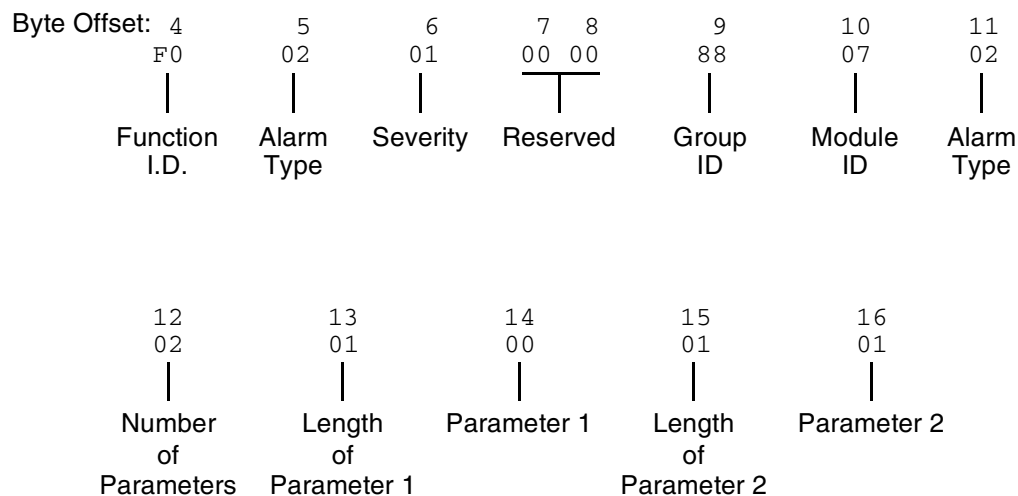

Function I.D. (byte offset 4) – Byte immediately following the Network Header; uniquely identifies the report from Circuit Interworking system.

Alarm Type (byte offset 5) – Specifies what type of alarm the system sent.

02 – Link unavailable

04 – Link available

Severity (byte offset 6) – Specifies the alarm level.

00 – Information

01 – Minor

Reserved (byte offsets 7 and 8) – Always 00 00.

Group ID (byte offset 9) – Always 88.

Module ID (byte offset 10) – Always 07.

Alarm Type (byte offset 11) – Specifies what type of alarm the system sent (same as byte offset 5).

02 – Link unavailable

04 – Link available

NOTE: Together, byte offsets 9, 10, and 11 form an alarm number described in the Alarms and Errors section of the NewNet AccessManager Maintenance Manual.

Number of Parameters. (byte offset 12) – Specifies how many parameters are included in the report.

Length of Parameter 1 (byte offset 13) – Length of Parameter 1 in bytes.

Parameter 1 (byte offset 14) – Linkset number. Linkset numbers are derived by the order in which they appear in the MTP MML file, starting with 0.

Length of Parameter 2 (byte offset 15) – Length of Parameter 2 in bytes.

Parameter 2 (byte offset 16) – Link number (same as the SLC number).

6.6 CIRCUIT INTERWORKING COMMANDS AND REPORTS (Extended)

This section describes the commands and reports used by the Integrated SS7 system in Extended Operational Mode. Refer to the *Programming Reference* for additional information on non-SS7 commands and reports used by Circuit Interworking.

6.6.1 SS7 Circuit Query (\$30 01) Command (Extended)

Command Type: System Status

Description:

Initiates a query of the SS7 circuit states for one or all trunk groups. An SS7 Circuit Status (\$B0 01) report is generated back to the host.

Usage Guidelines:

You may use this command at any time, but it is recommended that its use be restricted to periods of low traffic.

Format:

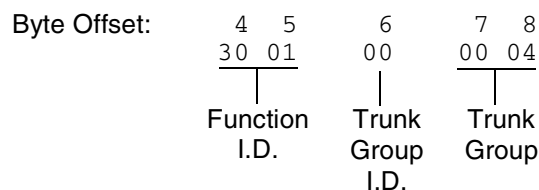

Function ID (byte offsets 4 and 5) – Byte immediately following the Network Header. The Function ID uniquely identifies the command to the Integrated SS7 system.

Trunk Group ID (byte offset 6) – Specifies the trunk group to query. Specify the byte according to the list below:

00 – Query trunk group specified in byte offsets 7 and 8

01 – Query all trunk groups.

Trunk Group (byte offsets 7 and 8) – Specifies trunk group. If “all trunk groups” are specified in byte offset 6, must be set to 00 00.

Network Status Byte:

The following network status bytes are returned by the \$30 01 Command:

Status Byte	Meaning
\$01	Command processing successful. Indicates command sent to the system has been processed successfully. Returned only when Return All is specified in the command's Network Control byte. No corrective action required.
\$D0	Invalid Trunk Group ID.
\$41	Invalid host message length.

6.6.2 SS7 Circuit Sync (\$30 02) Command (Extended)

Command Type: Configuration Control

Description:

Synchronizes the CktInt circuit states of one or all trunk groups with the underlying TUP layer.

Usage Guidelines:

This command may be used at anytime, but it is recommend that its use be restricted to periods of low traffic.

This command can be used in case the need arises to make sure the circuit states are consistent with what is maintained in the TUP layer.

Format:

Byte Offset:	4 5	6	7 8
	30 02	00	00 04
	Function	Trunk	Trunk
	I.D.	Group	Group
		I.D.	

Function ID (byte offsets 4 and 5) – Byte immediately following the Network Header. The Function ID uniquely identifies the command to the Integrated SS7 system.

Trunk Group ID (byte offset 6) – Specifies the trunk group to sync. Specify the byte according to the list below:

00 – Sync trunk group specified in byte offsets 7 and 8

01 – Sync all trunk groups.

Trunk Group (byte offsets 7 and 8) – Specifies trunk group. If “all trunk groups” are specified in byte offset 6, must be set to 00 00.

Network Status Byte:

The following network status bytes are returned by the \$30 02 Command:

Status Byte	Meaning
\$01	Command processing successful. Indicates command sent to the system has been processed successfully. Returned only when Return All is specified in the command's Network Control byte. No corrective action required.
\$D0	Invalid Trunk Group ID.
\$41	Invalid host message length.

6.6.3 SS7 Network Message Generation (\$49) Command (Extended)

Command Type: Resource Control

Description:

The SS7 \$49 Command is used for all call control functions for an SS7 call, including connecting an incoming and outgoing port, and forcing SS7 call origination. Non-SS7 network interface ports can also be controlled with this command in an interworking scenario. The \$49 Command functions as follows:

Set Disconnect Control – Each SS7 \$49 Command for an SS7 controlled port sets the Disconnect Control values. Therefore the command must specify the desired Disconnect Control values. This allows it to be changed after a call has been established.

Create Call – To allocate an internal call object for maintaining connection relationships and take the SS7 controlled port(s) off-hook, you must set the Switching and Attaching bits in the Connection Control byte in the first SS7 \$49 for the call.

Release Call – To deallocate the internal call object and put the SS7 controlled port(s) on-hook, you must set the Switching bit in the Connection Control byte of the \$49 Command releasing the call. Do not set the Attaching bit.

Associate Ports – To make the system consider the Disconnect Control values in a \$49 Command for a non-SS7 controlled port, associate the port with an SS7 controlled port in the call object. You can do this at anytime by providing the non-SS7 port as the other Port Address, either Controlling or Associated.

Send TUP Message – Set the Template Control byte or the TUP Message Type byte to send a TUP message through the Associated Port Address.

- If both the Controlling and Associated Port Addresses are not SS7 controlled or not specified, then network status byte \$03 is returned.
- If the TUP Message Type byte is zero (0) then no TUP message is sent.

Usage Guidelines:

To use the SS7 \$49 Command to generate a TUP message, the destination VCA must be set to \$C1, and either byte offset 17 (TUP Message Type) must be set for the message type, or byte offset 31 (Template Control) must be set to the template number.

Use this command for SS7 call control functions, including connecting an incoming and outgoing port, and forcing SS7 call origination. Control over the contents of SS7-generated messages is provided.

Total command length cannot exceed 306 bytes.

The controlling port is specified by port address.

A virtual port is not required to originate an outgoing call. Set the Control Address ID to 0, if you want the Controlling Port Address to be used by the host for tracking purposes.

You can choose the associated (outgoing) port two ways: specify by port address or hunt through a resource group.

The returned command is truncated to report only through byte offset 26 (Associated Address I.D.).

In interworking scenarios, either the controlling or associated port can be a non-SS7 port.

If you specify parameters, their values must be coded as they would appear in an SS7 message. Parameters you specify in the command are included in the next SS7 message transmission. The host-specified parameters are added to any SS7 parameters included in the template being executed.

Format:

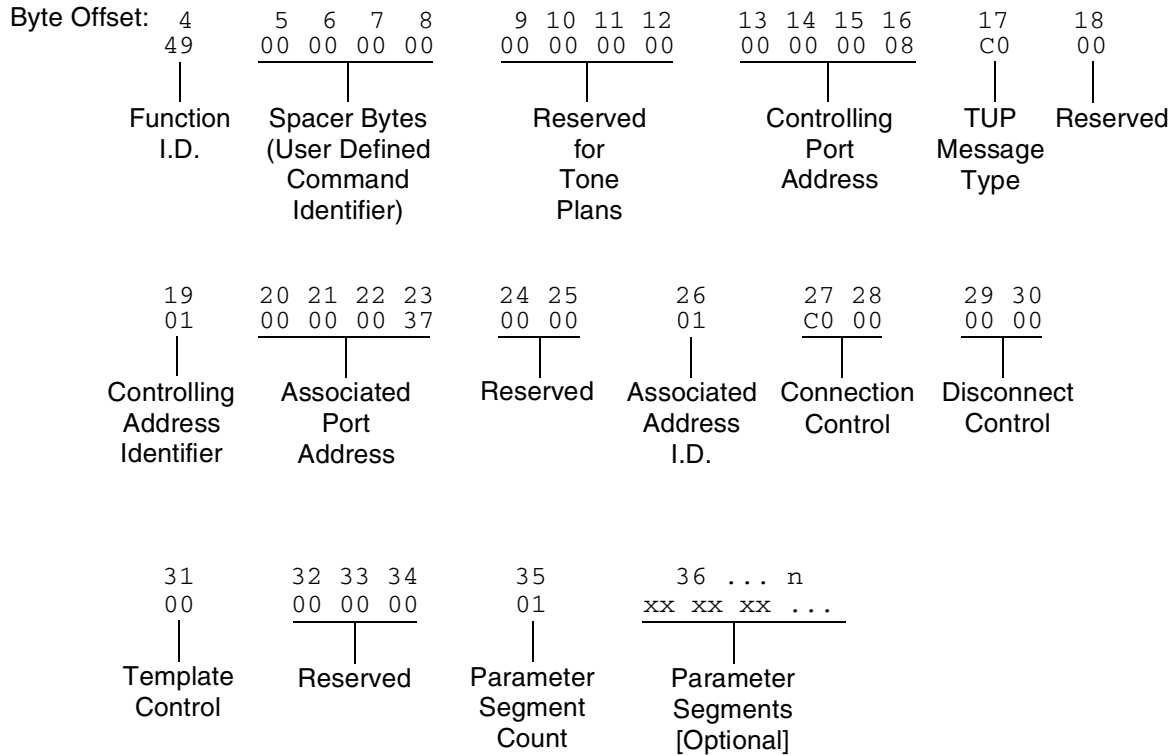

Function I.D. (byte offset 4) – Byte immediately following the Network Header; uniquely identifies the command to Circuit Interworking.

Spacer Bytes (User Defined Command Identifier) (byte offsets 5 to 8) – Reserved for the host. Since these are echoed back in the command response, you can use them to reference or “name” calls.

Reserved for Tone Plans (byte offsets 9 to 12) – Reserved for future tone plan specifications.

Controlling Port Address (byte offsets 13 to 16) – Hex representation of the controlling port circuit address for which the command is sent.

TUP Message Type (byte offset 17) – The TUP messages to generate only if the Template Control byte (byte offset 31) is set to zero.

Reserved (byte offset 18) – Always 00

Controlling Address I.D. (byte offset 19) – Specify the byte according to the following:

00 – no controlling address used in command. Controlling Port Address may be used by the host for tracking purposes. (To initiate outbound SS7 calls, set to 00.)

01 – controlling port specified by port address

Associated Port Address (byte offsets 20 to 23) – Hex representation of the associated (outgoing) port circuit address for which the command is sent or the resource group number from which to select the outgoing port. The Associated Address I.D. (byte offset 26) must be set to \$01.

Reserved (byte offset 24 and 25) – These bytes must be set to 00 00.

Associated Address I.D. (byte offset 26) – Specifies that the associated (outgoing) port is identified by port address/resource group. Specify the byte according to the list below:

00 – no associated address used in command

01 – associated port specified by port address, or resource group number

Connection Control (byte offsets 27 and 28) – Specifies the switching, attaching, and hunting options when this command is used to connect a call. Byte offset 28 is reserved for future enhancements and must be set to \$00. Construct byte offset 27 according to the descriptions below, then convert to hex for use in the command.

SAPVV000

S – Specifies if switching action is required

S = 0 – No switching action required; A bit ignored and should set to 0.

S = 1 – Switching action required.

A – Specifies whether to link or remove a resource

A = 0 – If S = 1, remove resource from call; if S = 0, no meaning.

A = 1 – If S = 1, link resource to call; if S = 0, no meaning.

P – Specifies whether to use a specific outgoing circuit or to select any outgoing circuit from a resource group; port address or group number is specified in Associated Port Address bytes

P = 0 – For S = 0 or 1, use port specified in Associated Port Address bytes.

P = 1 – For S = 1, select port from resource group specified in Associated Port Address bytes; the port address of the selected channel is specified in the command returned to the host.

VV – Not used for SS7. Set to 00.

Disconnect Control Bytes

The Disconnect Control bytes are always included in the command. You can only define byte offset 29 at this time. Byte offset 29 specifies the disposition of ports when the call is torn down. Byte offset 30 is reserved for future enhancements and should be set to \$00.

Bit settings in this byte are overridden if another \$49 Command is processed for either port in this \$49 Command.

Disconnect Control (byte offset 29 and 30) – Determines what actions to take on a port when the opposite end goes on hook. Construct byte in binary according to the descriptions below, then convert to hex for use in the command.

000010U0

I – Specifies whether to return the incoming port to CP_SETUP state when the outgoing port goes on hook

I = 0 – force incoming to idle

I = 1 – set incoming to setup state upon outgoing disconnect; T must be 0

U – Specifies whether to return the outgoing port to CP_SETUP state when the incoming port goes on hook

U = 0 – force outgoing to idle

U = 1 – set outgoing to setup state upon incoming disconnect; C must be 0

Template Control Byte

The Template Control byte is always included in the command, and specifies the template to be used when transmitting an SS7 message.

Template Control (byte offset 31) – Specifies whether a template is to be used in this command and the template number, if any (see *Section 6.2*). Construct byte in binary according to the descriptions that follow, then convert to hex for use in the command.

X0RRRRRR

X – Specifies if a template is used in this command

X = 0 – no template specified. Use TUP Message Type byte (offset byte 7).

X = 1 – execute template specified in RRRRRR; I must be 0

RRRRRR – Specifies the template number.

Reserved (byte offsets 32 to 34) – Always 00 00 00.

Parameter Segment Count Byte

The Parameter Segment Count byte is used in all \$49 Commands and specifies how many parameters are included in the command.

Parameter Segment Count (byte offset 35) – Specifies how many parameters are included in the command. Convert from decimal to hex for use in the command. A value of 00 indicates that no parameters follow this byte.

Parameter Segment

The Parameter Segment bytes contain parameters to be transmitted to the SS7 network. The number of parameters contained in this segment appears in the Parameter Segment Count byte.

NOTE: Each time a \$49 command is sent, the parameters defined in that particular command override any permanent parameters set in the template it names in byte offset 31.

Each parameter consists of a Parameter Code byte, a Parameter Data Length byte, and one or more Parameter Data bytes. The format and components of the Parameter Segment are defined as follows:

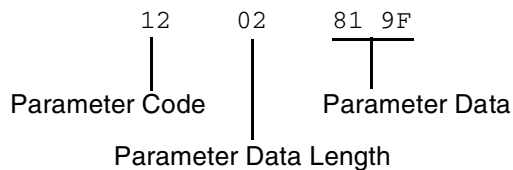

Parameter Code – Specifies the parameter code.

Parameter Data Length – Specifies the number of parameter data bytes.

Parameter Data – Specifies the parameter data exactly as it should be sent to the SS7 network.

Special Parameter Formats

The following TUP parameter formats in the SS7 \$49 command deviate from the formats specified in the China TUP protocol signaling specification document. All other parameters follow the protocol formats.

Calling Line Identity Parameter

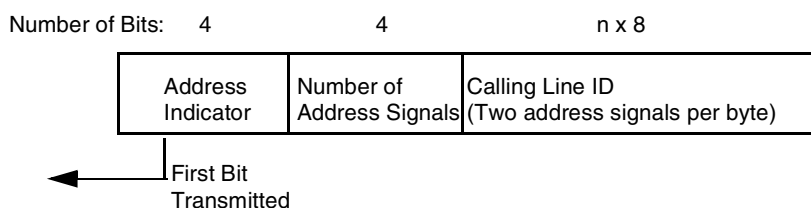

Figure 6.31: Typical Calling Line Identity Parameter Format (per protocol spec)

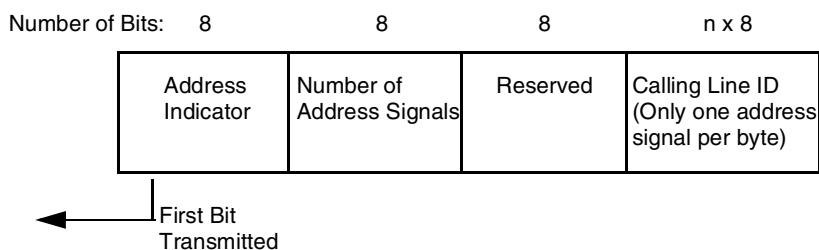

Figure 6.32: SS7 \$49 Command Calling Line Identity Parameter Format

Example

The calling party number is 0273321119.

According to the protocol, the parameter would be coded as follows:

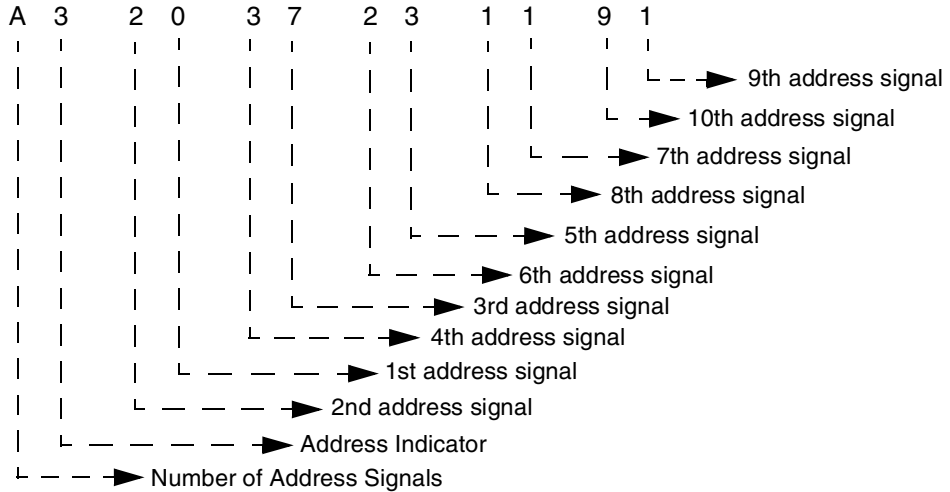

Figure 6.33: Sample Calling Line Identity Parameter Per Protocol Coding

For the SS7 \$49 Command, however, the parameter needs to be coded as shown below:

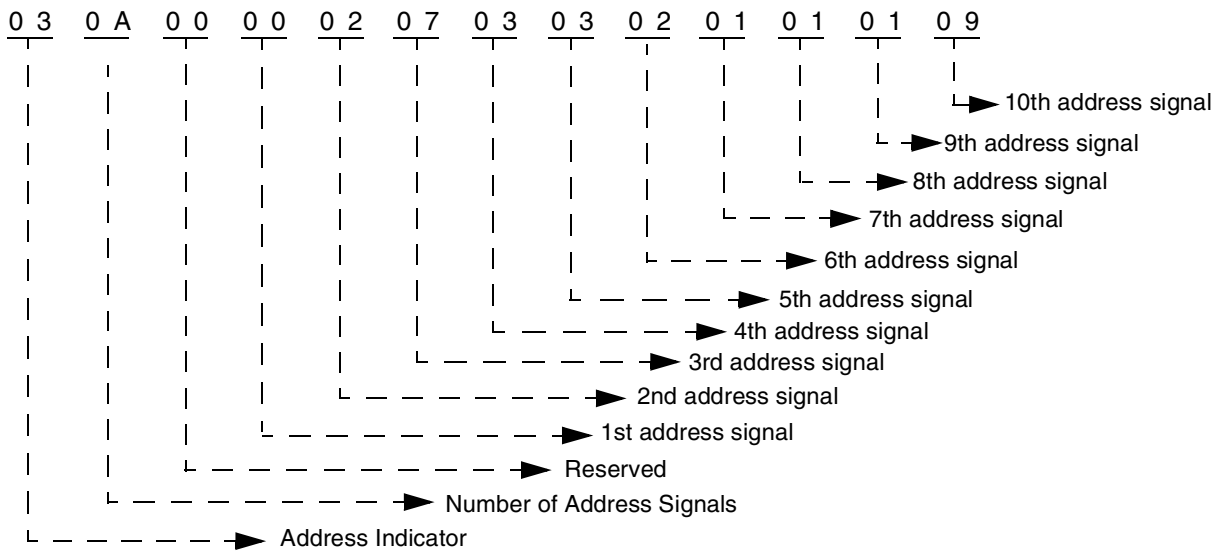

Figure 6.34: Sample Calling Line Identity Parameter Coding for SS7 \$49 Command

Original Called Address Parameter

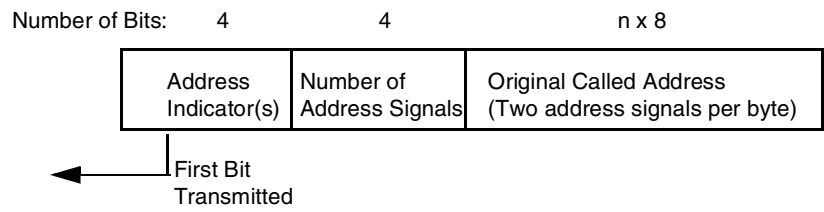

Figure 6.35: Typical Original Called Address Parameter Format (per protocol spec)

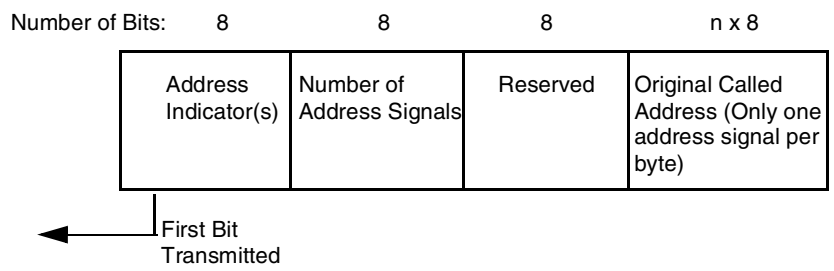

Figure 6.36: SS7 \$49 Command Original Called Address Parameter Format

Example

The called party number is 0273321119.

According to the protocol, the parameter would be coded as follows:

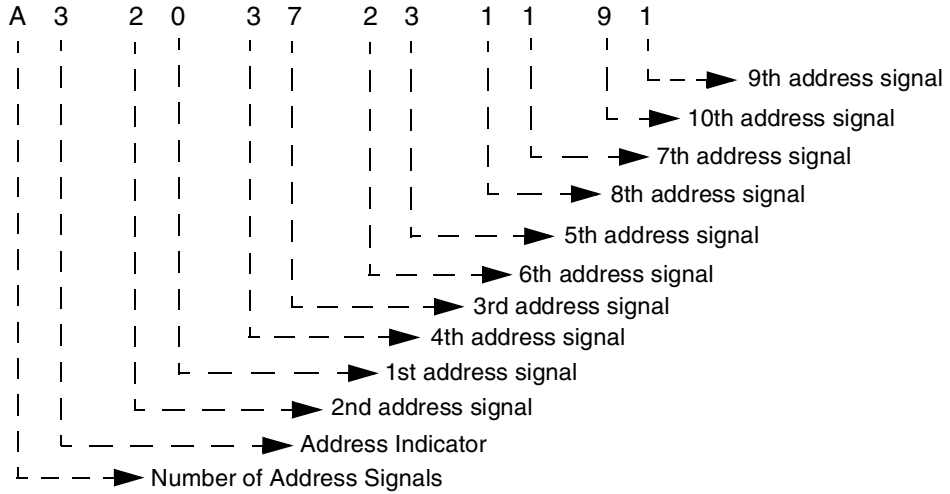

Figure 6.37: Sample Called Address Parameter Per Protocol Coding

For the SS7 \$49 Command, however, the parameter needs to be coded as shown below:

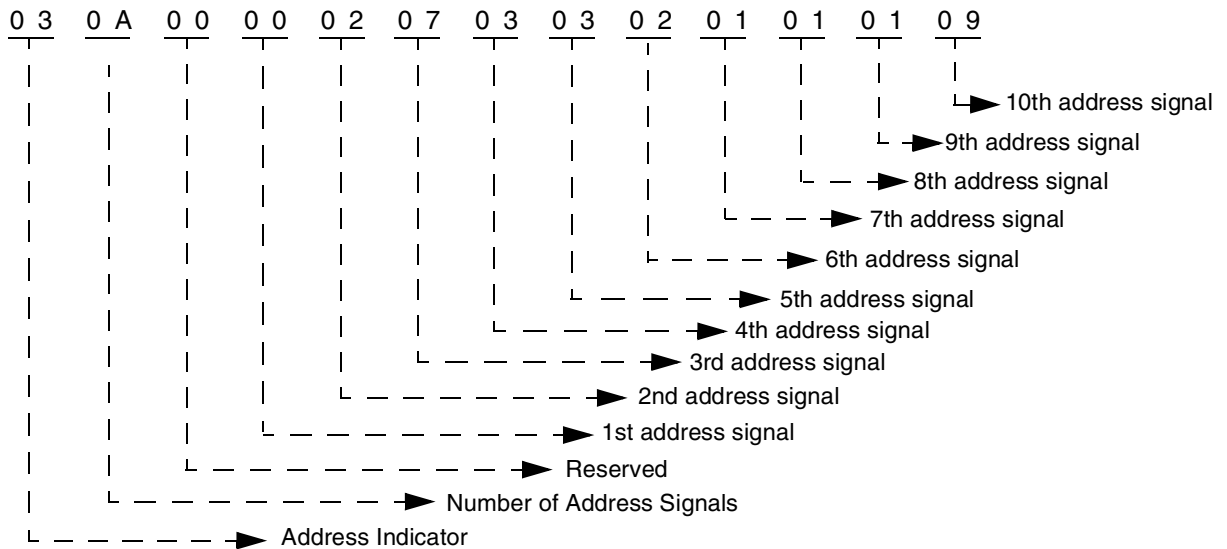

Figure 6.38: Sample Called Address Parameter Coding for SS7 \$49 Command

Incoming Trunk and Transit Exchange ID Parameter

NOTE: The Incoming Trunk and Transit Exchange ID parameter does not currently support a Signaling Point Code for the Identity Type Indicator.

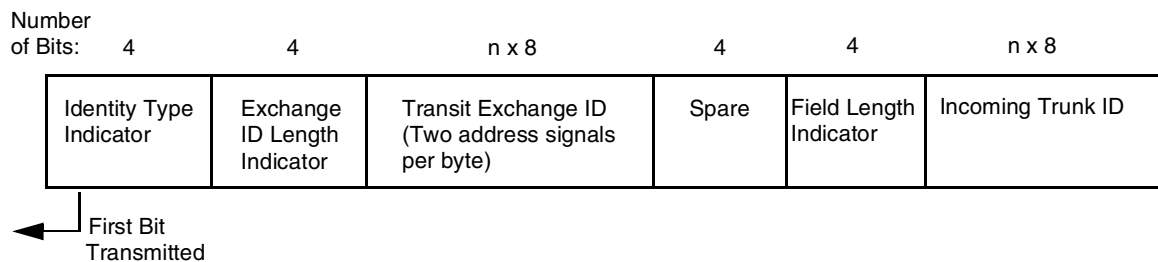

Figure 6.39: Typical Incoming Trunk and Transit Exchange ID Parameter Format (per protocol spec)

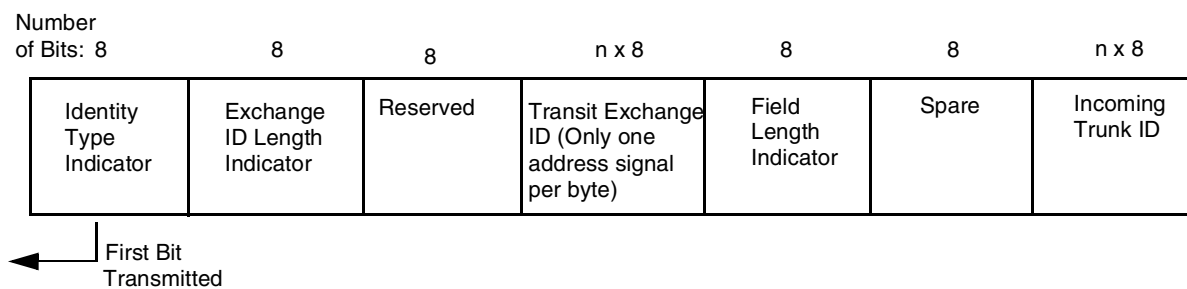

Figure 6.40: SS7 \$49 Command Incoming Trunk and Transit Exchange ID Parameter Format

Example

The calling party number is 0273321119.

According to the protocol, the parameter would be coded as follows:

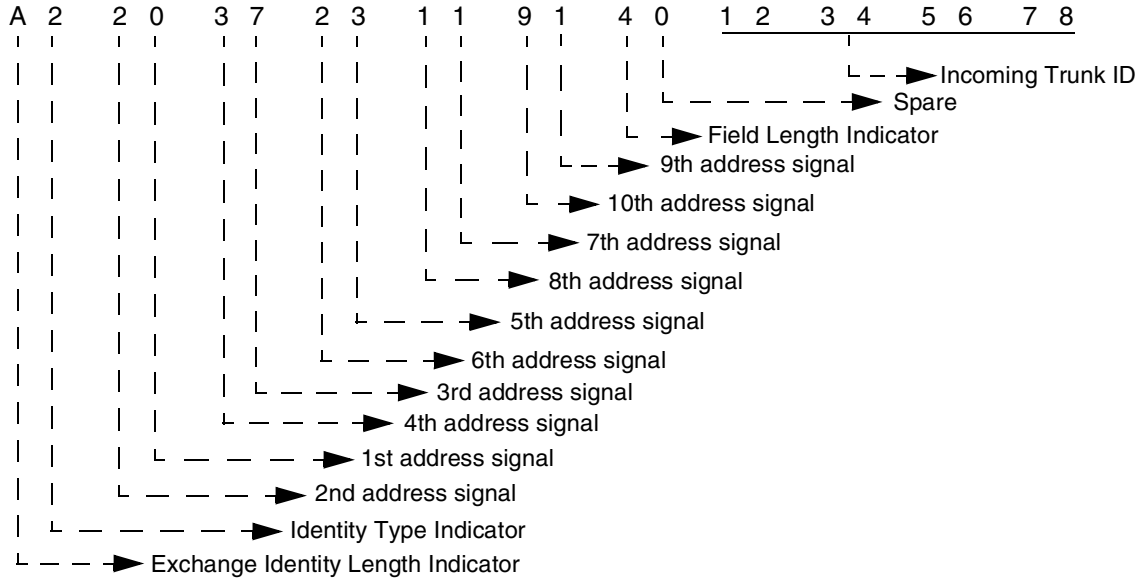

Figure 6.41: Sample Incoming Trunk and Transit Exchange ID Parameter Per Protocol Coding

For the SS7 \$49 Command, however, the parameter needs to be coded as shown below:

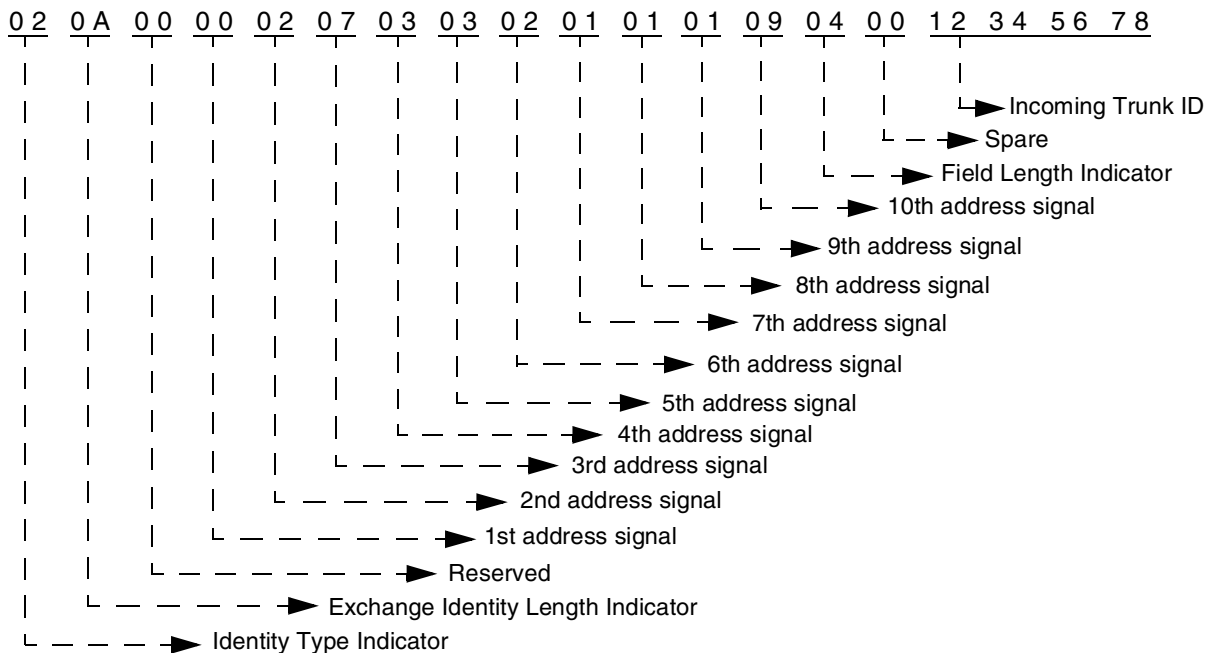

Figure 6.42: Sample Incoming Trunk and Transit Exchange ID Parameter Coding for SS7 \$49 Command

Network Status Byte:

The following network status bytes are returned by the \$49 Command:

Status Byte	Meaning
\$01	Command processing successful. Indicates command sent to the system has been processed successfully. Returned only when Return All is specified in the command's Network Control byte. No corrective action required.
\$03	Syntax error in command. Indicates one or more of the values specified in the command are invalid or that the command specifies no action or improper switching actions within the SAP bit settings. Specifying values in spacer or bytes reserved bytes may also cause syntax errors. Check all byte values in command.
\$08	Command received was received by Standby side but can only be processed on the Active side.
\$0D	Invalid resource group number. The resource group specified in the command is 0 or greater than 224. Check resource group number.
\$0E	Invalid controlling port address (not in valid range). The port address specified in the command is not within the range of system port addresses or that port address is not assigned. Check port address.
\$0F	Invalid controlling host
\$15	Invalid associated port address (not in valid range). Indicates the port address specified in the command is not within the range of system port addresses. Check port address or select a port from appropriate resource group.
\$2B	The Template number specified in the command is out of the range for a rule (1 to 32). Check value and resend command with correct value.
\$41	Invalid host message length
\$C7	Invalid range specified in group maintenance messages.
\$C8	Incoming port is in the wrong state.
\$C9	No resource available.
\$CA	Outgoing port is in the wrong state.
\$CB	Parameter error in the host command.
\$CC	Parameter error in the template file.

Status Byte	Meaning
\$CD	Invalid TUP message type.
\$CE	Missing Range and Status parameter.
\$CF	Protocol violation. This network status byte usually indicates that the TUP message type is invalid for the current call state.
\$D1	The Far End SP is unavailable.

6.6.4 SS7 Host Call Load Control (\$C0 04) Command (Extended)

Command Type: Configuration Control

Description:

Used in conjunction with the Host Control of Call Load feature in the Generic software (refer to the System Host Configuration screen in the *System Administrator's Guide*). When the feature is enabled, this command allows the host to indicate its ability to process all calls, existing calls only, or no calls.

Usage Guidelines:

The system verifies that the Host Control of Call Load feature has been enabled before processing the command. If the feature is not enabled in the Generic software, the command is returned with a network status byte of \$1B (feature not enabled) in the network header.

If the load control code is set to 00, normal call processing occurs with no restrictions.

If the load control code is set to 01, cktint does not send SS7 \$EA reports to the host or process SS7 \$49 commands containing call control messages from the host until the host sends an SS7 \$C0 04 command indicating that it is ready to process calls. All maintenance reports are still sent to the host; all maintenance message commands are also sent and processed.

In addition, if the load control code is set to 02, cktint does not send new call reports to the host or process commands containing IAM messages from the host until the host indicates that it is ready to process new calls. However, commands will still be accepted from and reports sent to the host for calls in progress.

You can use the SS7 \$C0 04 command various ways. For example, sending an SS7 \$C0 04 command with the load control code set to 01 would allow the host to perform some type of initialization before accepting calls (the default setting on startup when the Host Control of Call Load feature is enabled). With the load control code set to 02, current calls will be completed, but no new calls accepted—a “graceful shutdown.”

This command only affects operations with respect to the host from which it is received. If there are multiple hosts, the command must be sent by each host.

NOTE: On an SS7 system, the \$C0 04 command destination VCA must be set to \$C1; otherwise, this could result in tcp link state mismatches between the VCO/4K, cktint, and the host.

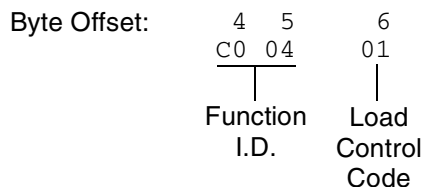
Format:

Function ID (byte offset 4 and 5) – Byte immediately following the Network Header. The Function ID uniquely identifies the command to the Integrated SS7 system.

Load Control Code (byte offset 6) – Determines whether the system should process incoming calls by reporting them to the host or reject call control commands sent by the host. Specify this byte according to the following list:

00 = Normal call processing

01 = Call processing suspended

02 = No new calls accepted or sent from the host; process existing calls only

Network Status Byte:

The following network status bytes are returned by the SS7 \$C0 04 Command:

Status Byte	Meaning
\$01	Command processing accepted. Indicates command sent to the system has passed initial processing. Returned only when Return All is specified in the command's Network Control byte. No corrective action required.
\$03	Syntax error in command.
\$1B	Host Control of Call Load feature is not enabled and command was not processed.
\$D2	VCO/4K is not connected and command was not processed.

Host Link States:

The following table summarizes possible Host Link States associated with the SS7 \$C0 04 Command:

Host Link State	Affect on Messaging
ONLINE_READY	Normal messaging. All host commands and reports allowed. Set by SS7 \$C0 04 host command with the load control code set to 00.
ONLINE_NOT_READY	<p>Call processing effectively suspended; all call control commands rejected.</p> <ul style="list-style-type: none"> • No new SS7 \$EA call reports sent. • No call control commands allowed; only configuration commands (i.e., \$C0 04, \$C0 01, \$30 01, \$30 02) and maintenance messages. <p>Set by SS7 \$C0 04 host command with the load control code set to 01.</p>
ONLINE_RESTRICTED	<p>Processing of calls in progress; host commands accepted.</p> <ul style="list-style-type: none"> • No SS7 \$EA report for new call reports for incoming IAM. • All host commands allowed, except SS7 \$49 command with IAM. <p>Set by SS7 \$C0 04 host command with the load control code set to 02.</p>

NOTE: If calls are present when the host goes ONLINE_NOT_READY, there can be a mismatch of circuit states among the VCO/4K, cktint, and the host.

When the Host Control of Call Load feature is enabled and there is a connection to the host, the initial tcp link state in cktint is ONLINE_NOT_READY. It stays in this state until receiving an SS7 \$C0 04 command from the host requesting a host link state change.

6.6.5 SS7 Host Assume/Relinquish Port Control (\$C0 05) Command (Extended)

Command Type: Configuration Control

Description:

Allows a host process to relinquish control of a call assigned to itself, or assume control of a call that has been assigned to a different host.

Usage Guidelines:

This command performs the assume/relinquish port control function. A function code allows a host link to override a controlling host assignment with one of two operating modes: one mode allows a host to assume control of a port; the other mode allows a host to relinquish control of a port. In either case, the assignment override remains in effect as long as the affected port is involved in a call, or until a subsequent override command is received. The relinquish mode clears the controlling host assignment for the specified port so that another host can take control of that port.

Format:

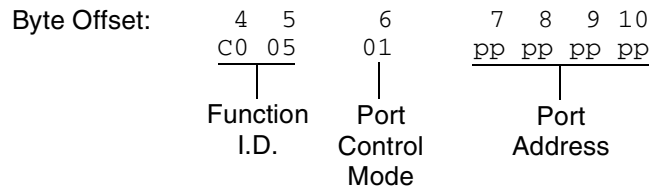

Function ID (byte offset 4 and 5) – Byte immediately following the Network Header. The Function ID uniquely identifies the command to the Integrated SS7 system.

Port Control Mode (byte offset 6) – Determines the type of action to be taken. Specify this byte according to the following list:

00 = Relinquish control

01 = Assume control

Port Address (byte offsets 7 to 10) – Port address for which control is being seized or relinquished.

Network Status Byte:

The following network status bytes are returned by the \$C0 05 Command:

Status Byte	Meaning
\$01	Command processing accepted. Indicates command sent to the system has passed initial processing. Returned only when Return All is specified in the command's Network Control byte. No corrective action required.
\$03	Syntax error in command. Indicates one or more of the values specified in the command are invalid or that the command specifies no action or improper switching actions within the SAP bit settings. Specifying values in spacer bytes or reserved bytes may also cause syntax errors. Check all byte values in command.
\$0E	Invalid controlling port address (not in valid range). Indicates the port address specified in the command is not within the range of system port addresses or that port address is not assigned. Check port address.
\$C9	No resource available.

6.6.6 SS7 Circuit Status (\$B0 01) Report (Extended)

Report Type: System Status

Description:

Reports the SS7 circuit states for a trunk group.

Action Causing Report Generation:

Generated in direct response to an SS7 Circuit Query (\$30 01) Command. If all trunk groups were requested, then multiple reports are generated, one for each trunk group.

Format:

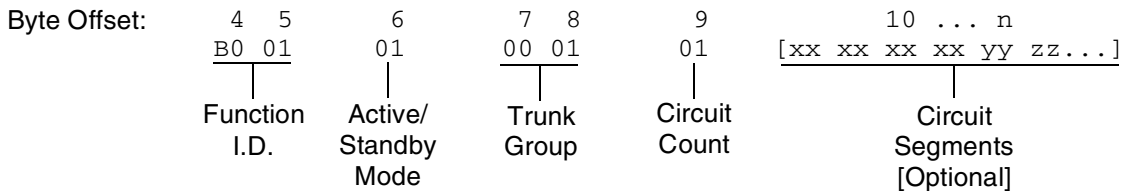

Main Command Segment

Function ID (byte offsets 4 and 5) – Bytes immediately following the Network Header; uniquely identifies this report from Circuit Interworking.

Active/Standby Mode (byte offset 6) – Indicates active/standby mode. Non-redundant systems will always return active mode.

0 = Standby mode

1 = Active mode

Trunk Group (byte offsets 7 and 8) – Specifies the trunk group.

Circuit Count (byte offset 9) – Indicates the number of circuit segments that follow. This will be a value from 0 to 32.

Circuit Segments

Circuit Segments (byte offset 10 – n) – Each segment consists of six bytes. They are the Circuit Port Address (4 bytes), the Circuit State/Call State (1 byte), and the Circuit Sub State (1 byte). The number of circuit segments is specified by the Circuit Count.

Circuit Port Address – The VCO/4K port address associated with this circuit.

Circuit State/Call State – The (maintenance) state of this circuit. The possible hex values are as follows:

FF	Unknown
00	Unequipped
01	Transient
10	Unequipped/Idle
12	Active/Idle
13	Remotely Blocked/Idle
14	Locally Blocked/Idle
15	Locally and Remotely Blocked/Idle
22	Active/Incoming Busy
23	Remotely Blocked/Incoming Busy
24	Locally Blocked/Incoming Busy
25	Locally and Remotely Blocked/Incoming Busy
32	Active/Outgoing Busy
33	Remotely Blocked/Outgoing Busy
34	Locally Blocked/Outgoing Busy
35	Locally and Remotely Blocked/Outgoing Busy

Circuit Sub State – The call state of this circuit. The possible hex values are as follows:

00	Idle
01	Delivered
02	Present
03	Answered
04	Released
05	Received
06	Initiated
07	Continuity
08	Reserved
09	Continuity Reserved
0A	Continuity Present
0B	Continuity Initiated
0C	Continuity Initiated Detected
0D	Continuity Initiated End
0E	Continuity End
0F	Continuity Previous Call Present
10	Continuity Previously Initiated

- 11 **Locally Suspended**
- 12 **Remotely Suspended**
- 13 **Local and Remote Suspended**

6.6.7 SS7 System Port Status (\$D3) Report (Extended)

Report Type: System Status

Description:

Informs the host of an attempted change in the status of a system resource port. Change can be the result of:

- Activating/deactivating a port or card span (refer to the *System Administrator's Guide*)
- Transmission or reception of an SS7 TUP Maintenance message

Action Causing Report Generation:

This report is generated when a change occurs in the operating status of an individual SS7 circuit. Status changes can be caused by an action at the system administrative console (isup_console), a host command, or a received SS7 TUP maintenance message.

A report indicating a port's availability may be returned from a circuit in Active mode. When a circuit is Out-of-Service, no other \$D3 reports are generated for that port.

Format:

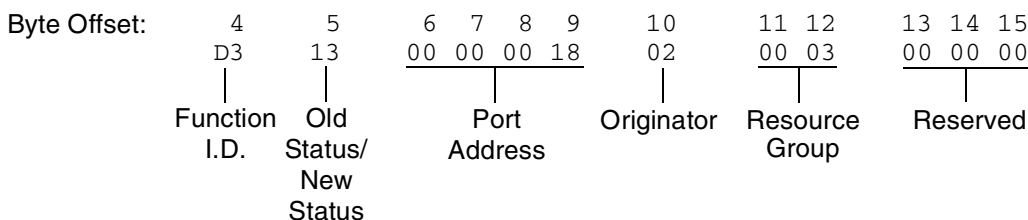

Function I.D. (byte offset 4) – Byte immediately following the Network Header; uniquely identifies the report from the system.

Old Status/New Status (byte offset 5) – Specifies the status of the port before the change occurred and the present status of the port. Convert byte from hex to binary and interpret the bits as described on the following page.

MMMMN>NNN

MMMM – specifies the status of the port before the change occurred

MMMM = 0001 – resource was unavailable (Out of Service)

MMMM = 0011 – resource was on line and available

NNNN – specifies the current status of the port

NNNN = 0001 – resource is currently unavailable (Out of Service)

NNNN = 0011 – resource currently on line and available

Port Address (byte offsets 6 to 9) – Hex representation of port address for which the report is generated.

Originator (byte offset 10) – Specifies whether the change in status was originated by the system or the host and the reason for the change. The following originator code values are added to the CktInt \$D3 reports sent to the host during SS7 events:

- 01 – A circuit group block (MGB/HGB) or a block (BLO) message was received from the SS7 network (SS7_BLOCKING event).
- 02 – A circuit group unblock (MGU/HGU) or a unblock (UBL) message was received from the SS7 network (SS7_UNBLOCKING event).
- 03 – A circuit group unblock acknowledge (MUA/HUA) or a unblock acknowledge (UBA) message was received from the SS7 network (SS7_UNBLOCKING_ACK event).
- 04 – A reset circuit (RSC), circuit group reset (GRS), release guard (RLG), or circuit group reset acknowledge (GRA) message was received from the SS7 network (SS7_RESET event).
- 05 – A change of port status from OFFLINE to ONLINE was received from the VCO/4K in the form of \$D9 or \$D3 reports (SDS_UNBLOCK event).
- 06 – A change of port status to OFFLINE was received from the VCO/4K in the form of \$D9 or \$D3 reports (SDS_BLOCK event).
- 07 – The user initiated a circuit group unblock (MGU/HGU) or unblock (UBL) message either through isup_console or through a host message (MAINT_UNBLOCK event).
- 08 – The user initiated a circuit group block (MGB/HGB) or block (BLO) message either through isup_console or through a host message (MAINT_BLOCK event).
- 09 – A circuit group reset (GRS) or reset circuit (RSC) was initiated by the host or a user through isup_console.

Resource Group (byte offsets 11 and 12) – specifies the resource group number to which the port belongs; convert byte from hex to decimal for the group number (1 to 32 inclusive).

Reserved (byte offsets 13 to 15) – These bytes must be set to 00 00 00.

6.6.8 SS7 Circuit Group State (\$D9) Report (Extended)

Report Type: Circuit Group Status

Description:

Informs the host of a change in the state of a circuit group.

Action Causing Report Generation:

Generated when cktint receives an incoming MGB/HGB/MGU/HGU/GRS from the network, system, or isup_console.

Format:

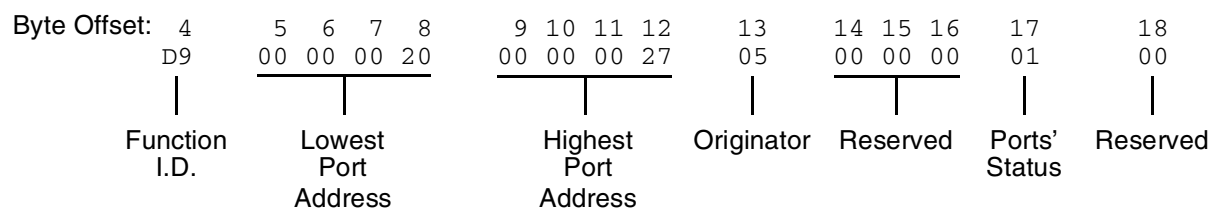

Function I.D. (byte offset 4)—Byte immediately following the Network Header; uniquely identifies the report from Circuit Interworking system.

Lowest Port Address (byte offsets 5 to 8)—Hex representation of the first port address of the circuit group for which the report is sent.

Highest Port Address (byte offsets 9 to 12)—Hex representation of the last port address on the card for which the report is sent.

Originator (byte offset 13)—Specifies whether the MGB/HGB/MGU/HGU/GRS message was originated by the system, host, or isup_console. The following originator code values are added to the CktInt \$D9 reports sent to the host during SS7 events:

- 01 – A circuit group block (MGB/HGB) message was received from the SS7 network
- 02 – A circuit group unblock (MGU/HGU) message was received from the SS7 network
- 03 – A circuit group unblock acknowledge (MUA/HUA) message was received from the SS7 network
- 04 – A circuit group reset (GRS) message was received from the SS7 network
- 05 – A circuit group reset acknowledge (GRA) message was received from the SS7 network
- 06 – A circuit group block (MGB/HGB) message was sent to the SS7 network (as the result of a \$D9 OOS report from the VCO)
- 07 – A circuit group block (MGB/HGB) message was sent to the SS7 network from the isup_console
- 08 – A circuit group reset (GRS) message was sent to the SS7 network

Reserved (byte offsets 14 to 16)—Always 00 00 00.

Ports' State (byte offset 17)—Indicates the present state of the ports for which the report is generated. Interpret this byte according to the list that follows:

01 – Available

02 – Unavailable

03 – Transient

Reserved (byte offset 18) – Always 00.

6.6.9 SS7 Network Message Reception (\$EA) Report (Extended)

Report Type: Resource Control

Description:

The SS7 \$EA Report informs the host of a change in the state of an SS7 call. A change of state occurs when an SS7 TUP message is received from the SS7 network. Both the affected SS7 controlling and associated ports are represented.

Ports identified in this report are SS7 ports only. Non-SS7 ports are never represented in an SS7 \$EA report. (i.e. ACM received from the network with one SS7 port and one non-SS7 port—only the SS7 port affected by the ACM will be represented in the report.)

This report may be truncated if the network header segment, base report, and parameters exceed 255 bytes in length. No indication of truncation is provided to the host.

Format:

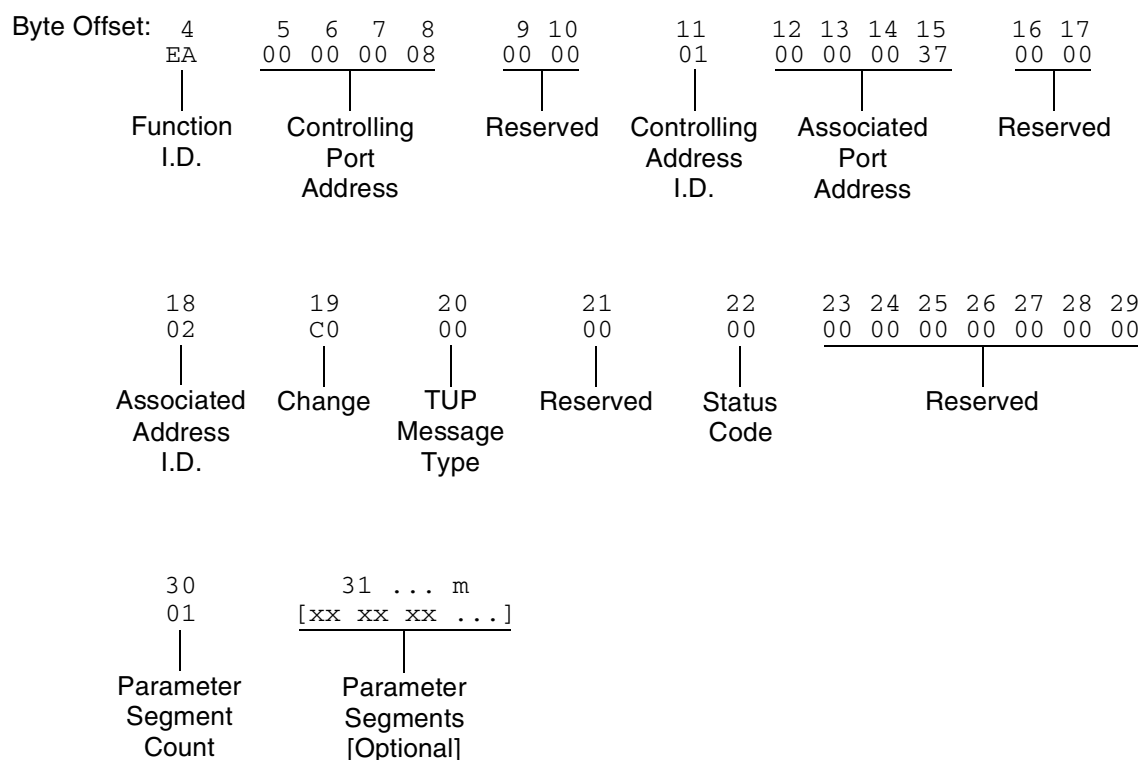

Function I.D. (byte offset 4) – Byte immediately following the Network Header; uniquely identifies the report from the system.

Controlling Port Address (byte offsets 5 to 8) – Hex representation of the controlling port address for which the report is sent. These bytes represent the specific circuit assigned to the call.

Reserved (byte offsets 9 and 10) – Always 00 00.

Controlling Address Identifier (byte offset 11) – Specifies the controlling port is identified by port address. Interpret the byte according to the list below:

01—Controlling port specified by port address.

Associated Port Address (byte offsets 12 to 15) – Hex representation of the associated (outgoing) port address for which the report is sent. These bytes represent the specific circuit used.

Reserved (byte offsets 16 and 17) – Always 00 00.

Associated Address I.D. (byte offset 18) – Specifies the associated (outgoing) port is identified by port address. Interpret the byte according to the list below:

00 – No associated port.

01 – Associated port specified by port address; Call ID = 00 00 for non-ISDN port address.

Change (byte offset 19) – Type of change detected. The list below provides a general indication of the change that occurred for the outgoing port:

00 – No change; report issued to send SS7 message

40 – Port became inactive (RLG, CLF message)

80 – Port became active (IAM or IAI received)

TUP Message Type (byte offset 20) – Indicates the SS7 message received. The message type is the hex value for the message. Refer to *Appendix E* for a list of the TUP messages and their function.

Reserved (byte offset 21) – Always 00.

Status Code (byte offset 22) – Indicates if an error was encountered. Interpret the byte according to the list below:

01 – No error

A4 – protocol violation

Reserved (byte offsets 23 to 29) – Always 00 00 00 00 00 00 00.

Parameter Segment Count Byte

The Parameter Segment Count byte is used in all SEA reports and specifies how many parameters are included in the report.

Parameter Segment Count (byte offset 30) – Specifies how many parameters are included in the command. Convert from decimal to hex for use in the command. A value of \$00 indicates that no parameters follow this byte.

Parameter Segment

The Parameter Segment bytes contain parameters to be received from the SS7 network. The number of parameters contained in this segment appears in the Parameter Segment Count byte.

Each parameter consists of a Parameter Code byte, a Parameter Data Length byte, and one or more Parameter Data bytes. The format and components of the Parameter Segment are defined as follows:

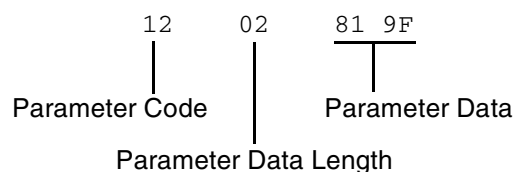

Parameter Code – Specifies the parameter code.

Parameter Data Length – Specifies the number of parameter data bytes; length of 00 indicates no parameter data.

Parameter Data – Specifies the parameter data exactly as it is received from the SS7 network.

Special Parameter Formats

The following TUP parameter formats in the SS7 SEA Report deviate from the formats specified in the China TUP protocol signaling specification document. All other parameters follow the protocol formats.

Calling Line Identity Parameter

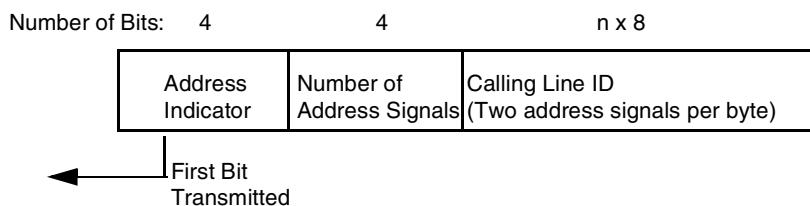

Figure 6.43: Typical Calling Line Identity Parameter Format (per protocol spec)

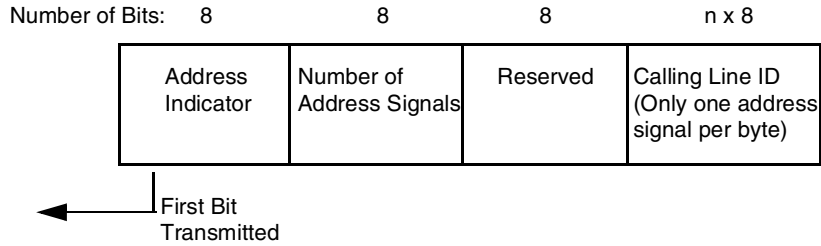

Figure 6.44: SS7 \$EA Report Calling Line Identity Parameter Format

Example

The calling party number is 0273321119.

According to the protocol, the parameter would be coded as follows:

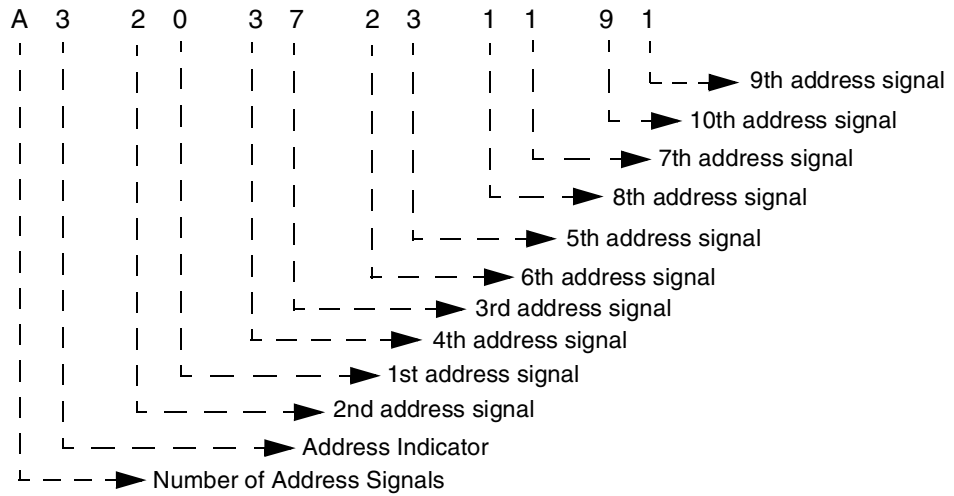

Figure 6.45: Sample Calling Line Identity Parameter Per Protocol Coding

For the SS7 \$EA Report, however, the parameter is coded as shown below:

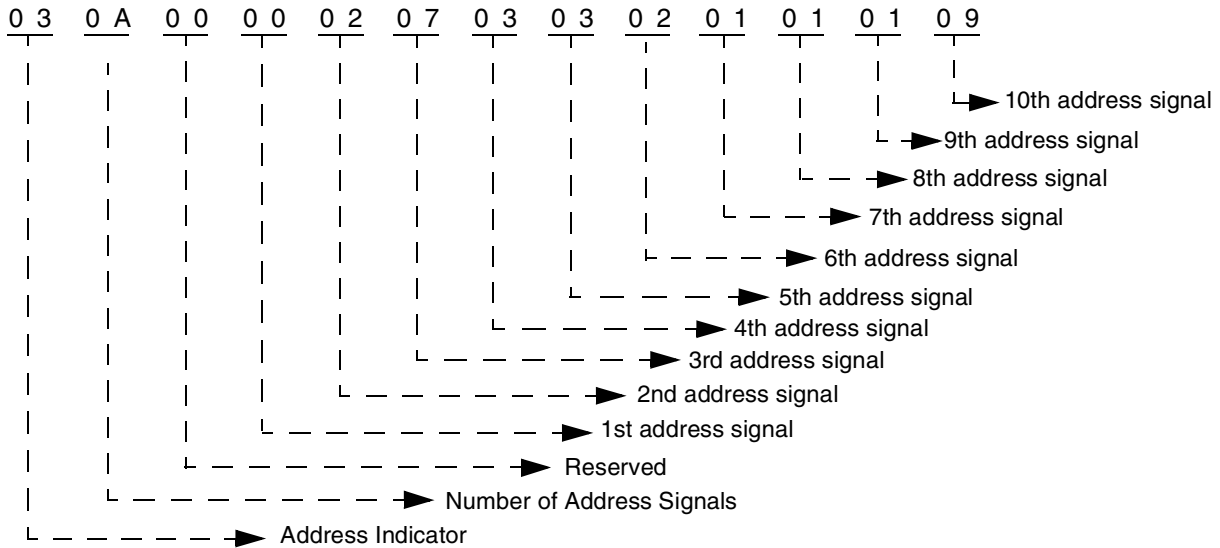

Figure 6.46: Sample Calling Line Identity Parameter Coding for SS7 \$EA Report

Original Called Address Parameter

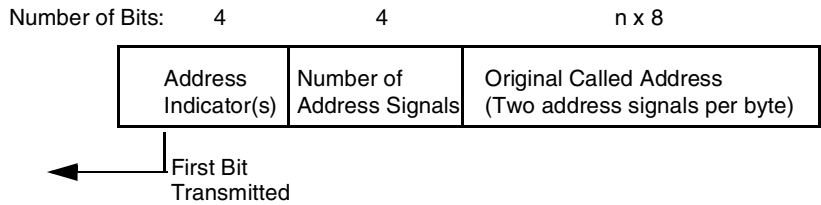

Figure 6.47: Typical Original Called Address Parameter Format (per protocol spec)

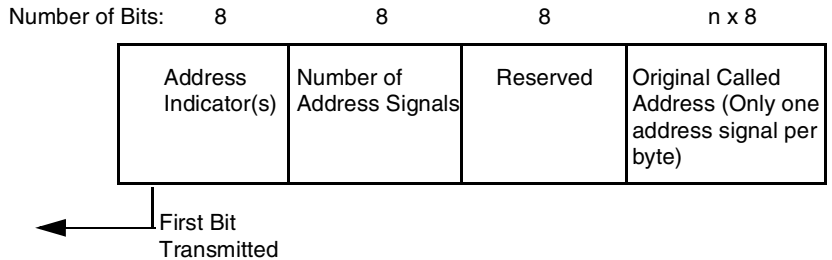

Figure 6.48: SS7 \$EA Report Original Called Address Parameter Format

Example

The called party number is 0273321119.

According to the protocol, the parameter would be coded as follows:

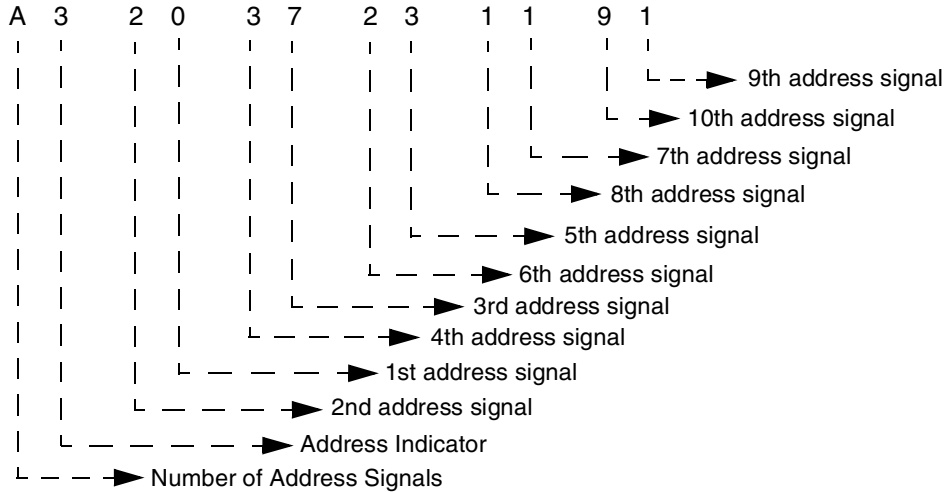

Figure 6.49: Sample Called Address Parameter Per Protocol Coding

For the SS7 \$EA Report, however, the parameter is coded as shown below:

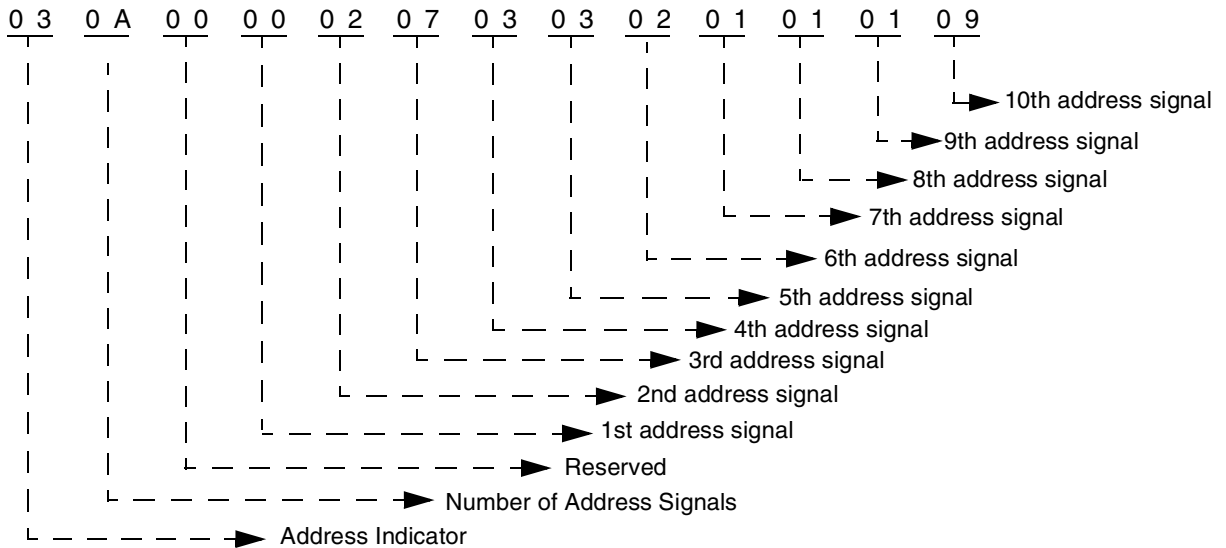

Figure 6.50: Sample Called Address Parameter Coding for SS7 \$EA Report

Incoming Trunk and Transit Exchange ID Parameter

NOTE: The Incoming Trunk and Transit Exchange ID parameter does not currently support a Signaling Point Code for the Identity Type Indicator.

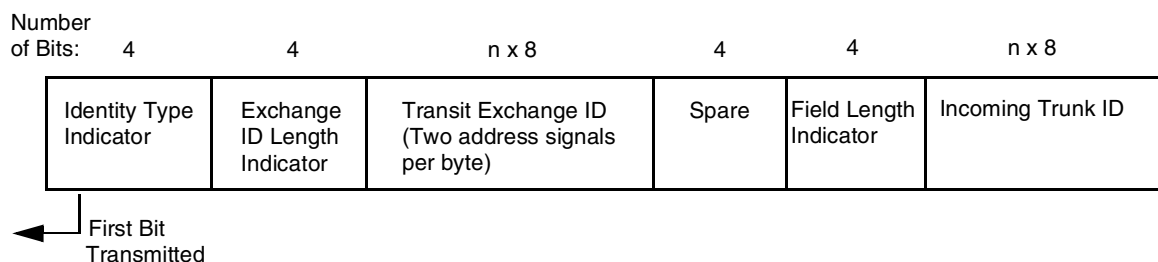

Figure 6.51: Typical Incoming Trunk and Transit Exchange ID Parameter Format (per protocol spec)

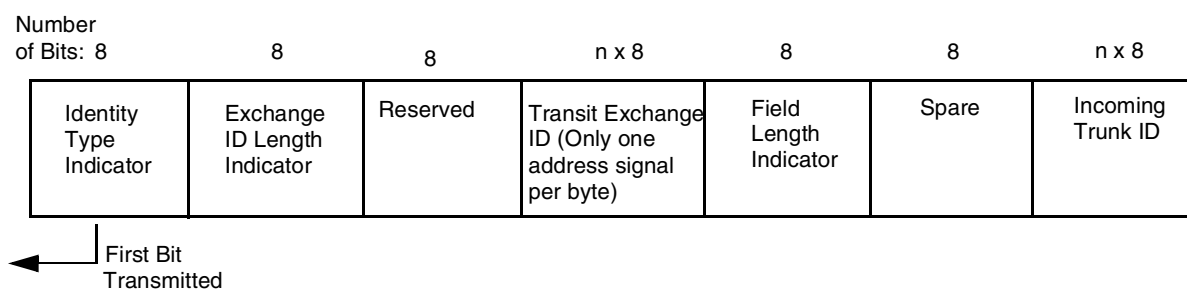

Figure 6.52: SS7 \$EA Report Incoming Trunk and Transit Exchange ID Parameter Format

Example

The calling party number is 0273321119.

According to the protocol, the parameter would be coded as follows:

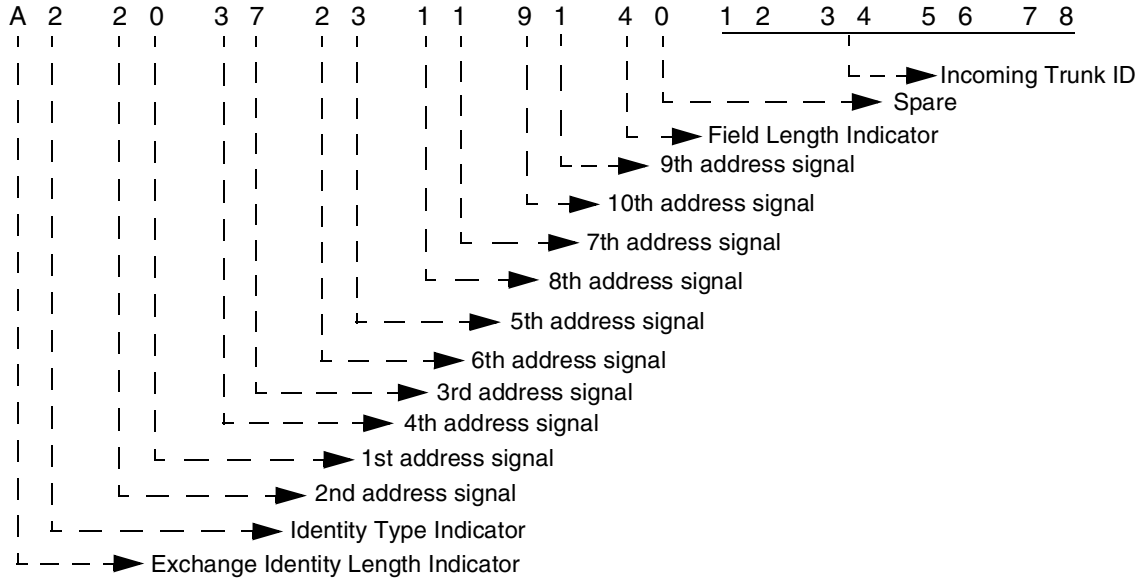

Figure 6.53: Sample Incoming Trunk and Transit Exchange ID Parameter Per Protocol Coding

For the SS7 SEA Report, however, the parameter is coded as shown below:

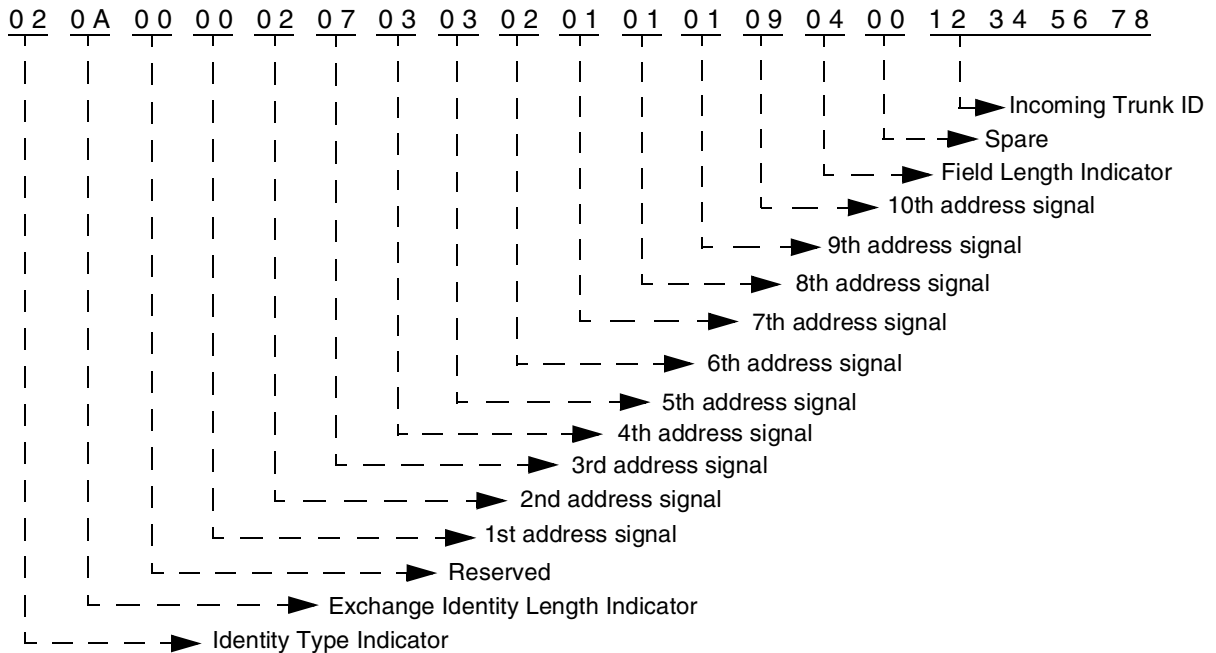

Figure 6.54: Sample Incoming Trunk and Transit Exchange ID Parameter Coding for SS7 SEA Report

6.6.10 SS7 Alarm Condition (\$F0) Report (Extended)

Report Type: System Status

Description:

Informs the host of the presence of specified system alarms, including alarm severity and type.

The SS7 \$F0 report allows the host the flexibility to take corrective action from a remote facility.

Action Causing Report Generation:

Circuit Interworking generates this report for the host when it detects link alarms—Link Unavailable (880702) or Link Available (880704)—at the MTP level. See the *NewNet AccessManager Maintenance Manual* for more information on specific alarms.

Format:

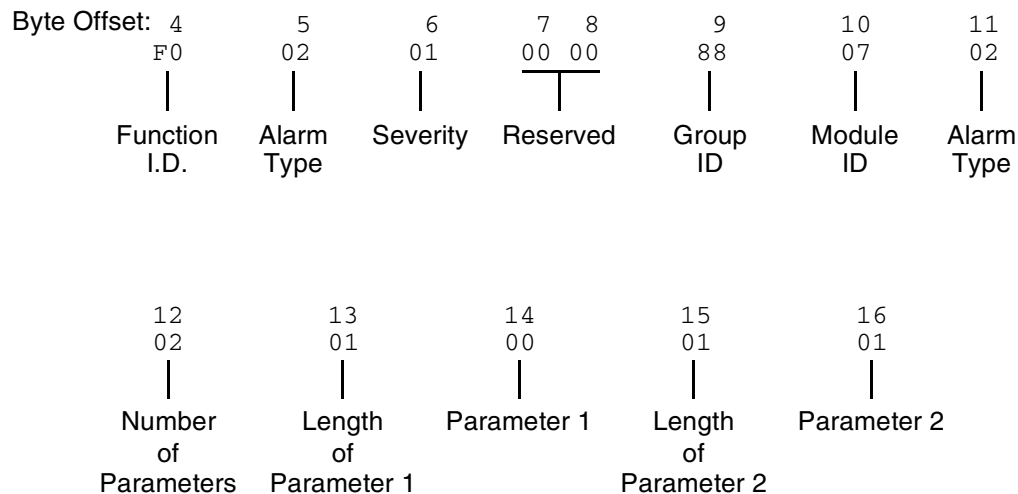

Function I.D. (byte offset 4) – Byte immediately following the Network Header; uniquely identifies the report from Circuit Interworking system.

Alarm Type (byte offset 5) – Specifies what type of alarm the system sent.

02 – Link unavailable

04 – Link available

Severity (byte offset 6) – Specifies the alarm level.

00 – Information

01 – Minor

Reserved (byte offsets 7 and 8) – Always 00 00.

Group ID (byte offset 9) – Always 88.

Module ID (byte offset 10) – Always 07.

Alarm Type (byte offset 11) – Specifies what type of alarm the system sent (same as byte offset 5).

02 – Link unavailable

04 – Link available

NOTE: Together, byte offsets 9, 10, and 11 form an alarm number described in the Alarms and Errors section of the NewNet AccessManager Maintenance Manual.

Number of Parameters. (byte offset 12) – Specifies how many parameters are included in the report.

Length of Parameter 1 (byte offset 13) – Length of Parameter 1 in bytes.

Parameter 1 (byte offset 14) – Linkset number. Linkset numbers are derived by the order in which they appear in the MTP MML file, starting with 0.

Length of Parameter 2 (byte offset 15) – Length of Parameter 2 in bytes.

Parameter 2 (byte offset 16) – Link number (same as the SLC number).

6.7 CALL FLOW EXAMPLES

This section provides you with three call flow examples. Each example shows the interaction between the various components on the network.

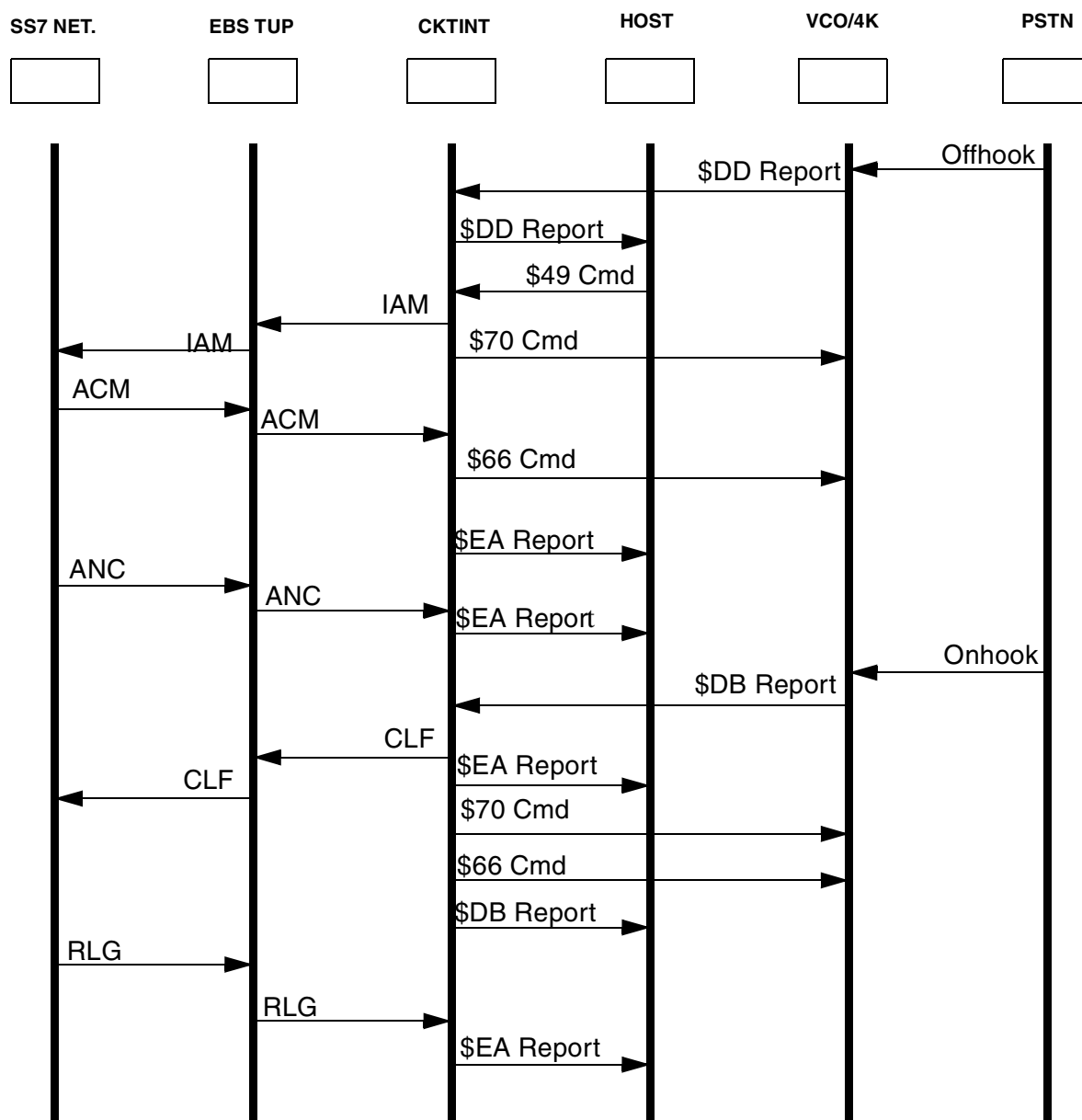

Figure 6.55: Non-SS7-To-SS7 Call Establishment

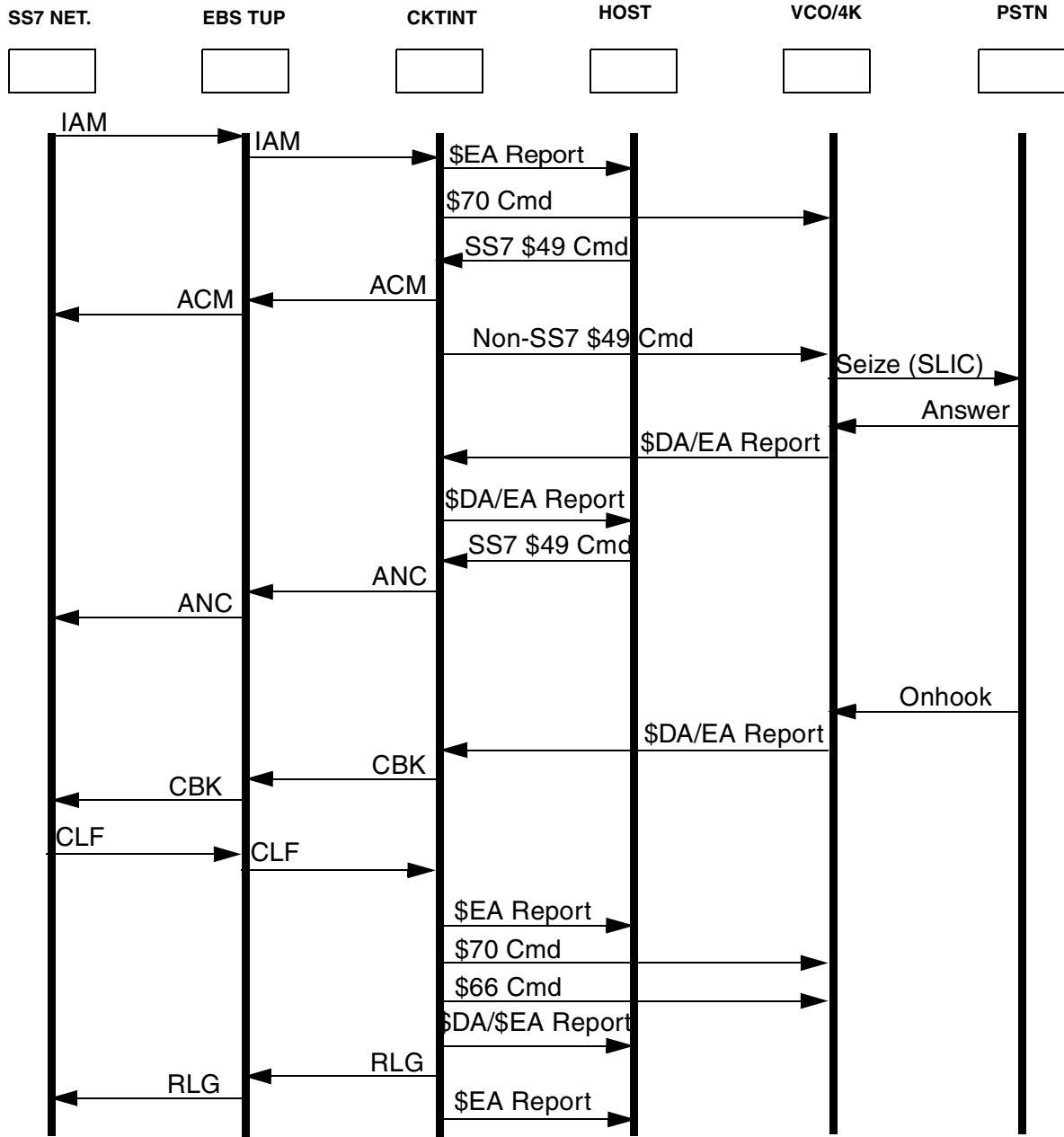

Figure 6.56: SS7-to-Non-SS7 Call Establishment

CALL FLOW EXAMPLES

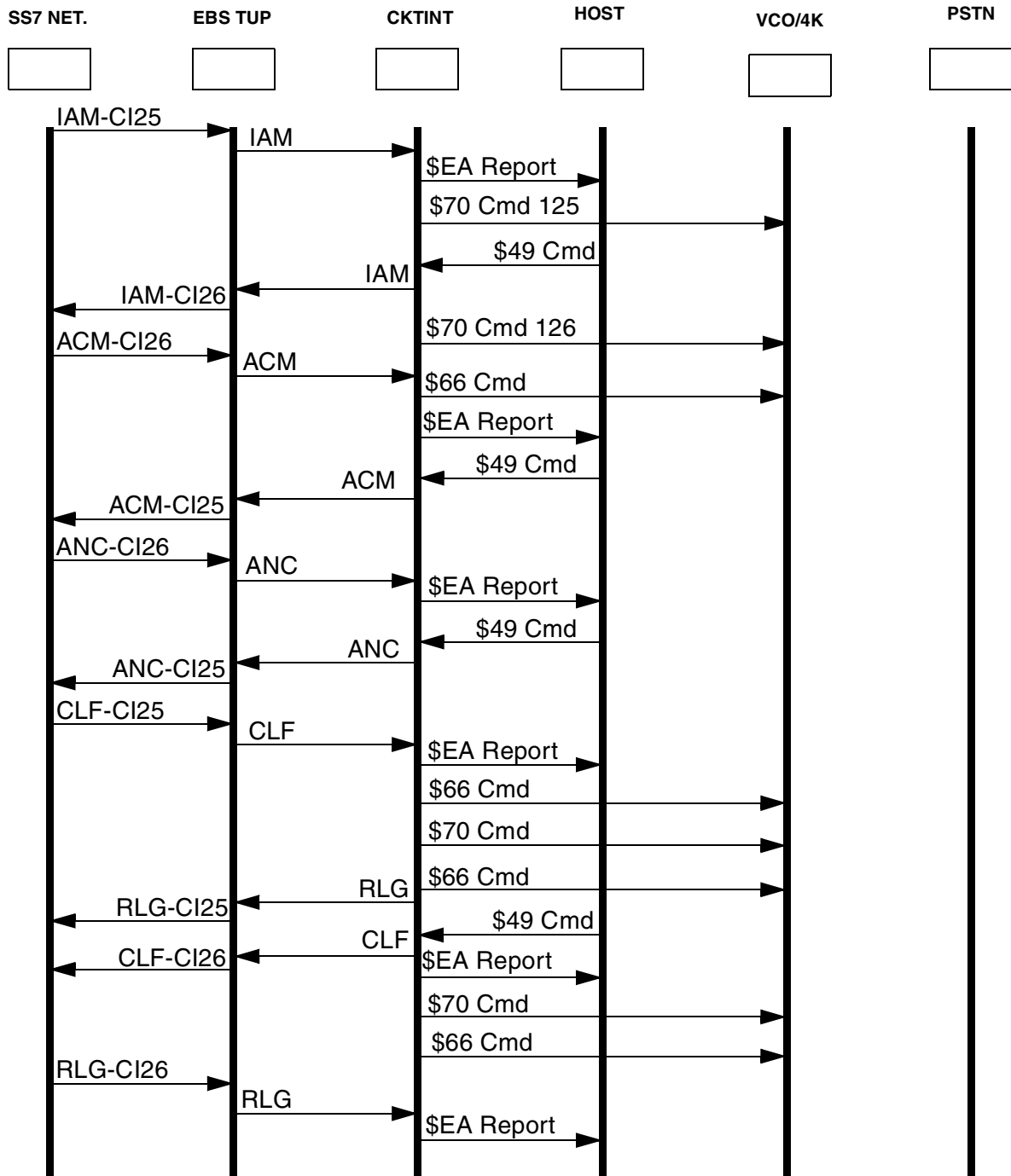

Figure 6.57: SS7-to-SS7 Call Establishment

6.7.1 Outbound COT Call Flow Examples

If your system is configured for outbound COT, the following events occur when the host sends an IAM with “continuity check required on this circuit.”

1. CktInt sends the IAM or IAI to the SS7 stack.
2. The SS7 stack responds to CktInt with a primitive type of TUP_START_OGCCOT, and CktInt puts the circuit’s substate to CONT_INITIATED.
3. CktInt sends a \$66 command to the VCO/4K to attach an TUP Tone (0x4D9 or 0x4D8) to the specific voice port. CktInt also sends a \$69 command to perform the outpulse rule.
4. The SS7 stack sends primitive type TUP_START_CHECKTONE to CktInt.

At this point, one of two sets of events occur:

1. CktInt receives a \$DA report from the VCO/4K indicating that an TUP Tone was detected (0x3107):
2. The circuit’s substate goes to CONT_INITIATED_DETECTED.
3. CktInt responds to the SS7 stack with TUP_BWD_CHECKTONE.
4. The SS7 stack sends CktInt an TUP_STOP_CHECKTONE.
5. The circuit’s substate goes to INITIATED.
6. CktInt sends TUP_STOP_CHECKTONE to the SS7 stack and the stack sends a COT (success) to the network.
7. The SS7 stack sends Cktint an TUP_STOP_OGCCOT.
8. CktInt sends a \$66 command to the VCO/4K to make the port listen to quiet (0x4C0).
9. The call proceeds with the network responding with an ACM.

—OR—

1. CktInt receives TUP_STOP_CHECKTONE.
2. The circuit’s substate goes to CONT_INITIATED_END.
3. CktInt receives a CCF message with primitive type TUP_STOP_OGCCOT, indicating a Continuity failure.
4. The SS7 stack sends a CCF message to the network.
5. CktInt receives a release with primitive type TUP_REATTEMPT.
6. CktInt sends the Continuity failure report to the host.
7. CktInt receives a TUP_START_OGCCOT with CCR from the network and sends it to the host.

NOTE: The host needs to re-initiate another outbound IAM or IAI upon a continuity failure.

Appendix A

UNIX/VI EDITOR BASICS

A.1 UNIX BASICS

Table A.1: UNIX Basics

Command	Function
man <command>	manual pages describing command (detailed information about specified command)
date	brings up time and date
exit	exits session
who	shows who is on the system
env	displays environmental variables
more <filename>	displays text one page at a time
pwd	<u>P</u> rint <u>W</u> orking <u>D</u> irectory
ls	<u>L</u> i <u>S</u> t files in directory
ls -aF	directories end with/ and hidden files
ls -l	long listing with added details
ls ~	list the contents of the home directory
ls -lrt	list long (detailed) names with latest date last
rm	remove (delete)
rmdir	remove directory
chmod 777 file.abc	change permissions for a file to all +r, +w, +x
chown owner <filename>	<u>C</u> hange <u>O</u> wner of file or directory (must own that file)
cp file1 file2	copy file 1 to file 2
cp ~/file.ext .	copies from file.ext from server home directory to current location
tar cvf <tarfile> <filenames>	creates tarfile from filenames
tar xvf <tarfile>	<u>e</u> Xtracts files from tarfile
tar tvf <tarfile>	output a <u>T</u> able of contents of tarfile
ps -ef	list all processes fully
su	<u>S</u> witch <u>U</u> ser (to root)

Table A.1: UNIX Basics (Continued)

Command	Function
tail <filename>	show file from the <u>T</u> AIL end
tail -f <file>	show new entries (i.e. tail -f cktint-Apr24.log)
fsck	<u>F</u> ile <u>S</u> ystems che <u>C</u> K
df -k	<u>D</u> isk <u>F</u> ree (in Kilobytes) - shows disk utilization
du -k	<u>D</u> isk <u>U</u> talization - shows space used by files in current directory, and those below (in Kilobytes)
jobs	show jobs running in background
fg <number>	brings job <number> to foreground
ctrl z	stops current process
bg	places stopped process in the background
kill <pid>	kills specified process (see ps -ef above)
Press "break" key (often F5), then, depending on prompt: >b -s [or] ok boot -s	Boots system into single user mode
vi <file>	enter vi editor

A.2 VI EDITOR

Table A.2: vi editor Commands

Command	Function
ESC	escape back to command mode
i	insert at cursor
a	append after cursor
x	delete under cursor
r	replace character under cursor
R	replace (typeover) a line
dw	delete word
dd	delete line
4dd	delete 4 lines
Y or yy	yank line (copy)
5Y or yy	yank a copy of 5 lines
p	put line (paste) below
P	put line above current line
u	undo last change
o	open line below
O	open line above
G	go to end of file
1G	go to first line of file
ctrl f	page forward
ctrl b	page backward
:q!	quit, do not save
:wq	write and quit
:sh	escape to shell (exit to return to vi)
!<command>	execute UNIX command

Appendix B FILE STRUCTURE

B.1 CKTINT CONFIGURATION

Figure B.1 is a illustration of the directory structure for the cktint configuration.

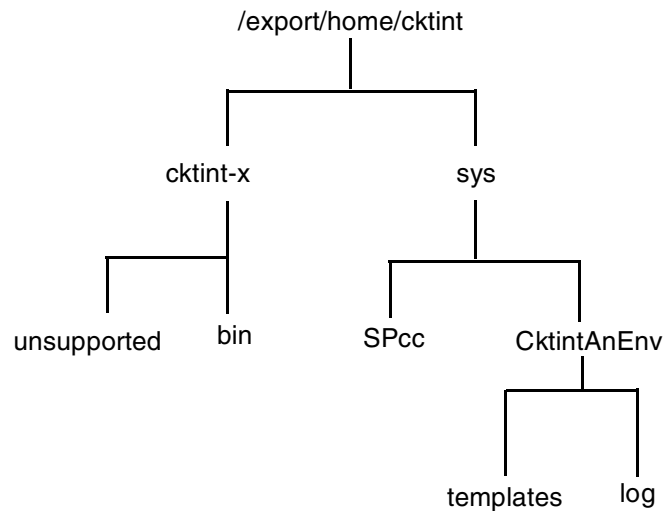

Figure B.1: Cktint Directory Tree

Table B.1: Cktint Directories

UNIX Directory Path	Shortcut	Contents
/export/home/cktint	\$HOME	Subdirectories for the product
/export/home/cktint/cktint-x/bin	\$BIN	Startup scripts
/export/home/cktint/cktint-x/unsupported	\$UN	The host emulator tool
/export/home/cktint/sys/CktintAnEnv	\$XNV	All the executables and the configuration files used by cktint
/export/home/cktint/sys/CktintAnEnv/templates	\$XNV/ templates	The template files used by the cktint
/export/home/cktint/sys/CktintAnEnv/log	\$XNV/log	The log directory
/export/home/cktint/sys/SPcc	\$SPC \$SPC1...7	.mml configuration files for China

Appendix C

UPGRADING/RE-INSTALLING THE OPERATING PLATFORM

C.1 INTRODUCTION

The Solaris Operating System is loaded on the Integrated SS7 system at the factory. The information in this appendix is supplied in the event you need to upgrade or re-install the software.

C.2 PREPARING FOR UPGRADE/RE-INSTALLATION

1. If you have a redundant system, upgrade/install the Standby (SBY) side first.
2. Put the switch in the "A-ACT/B-SBY" state by running the Switch Active Side to Standby utility from the VCO/4K System Administration Console on the active side of the system. (Refer to the *VCO/4K System Administrator's Guide* for information on the utility.)
3. Hard-select the ACT side.
4. Move the VCO/4K AAC card's "Select Switch" from the "auto" position to the "A-ACT side."
5. Move the SS7 Fallback Switch "Select Switch" from the "auto" position to the "A-ACT side."

C.3 RELOADING THE SOLARIS OPERATING SYSTEM

1. Log in to the Integrated SS7 system as **cktint**.
2. On the standby side, enter the following command and press **Return**:

```
stop-ss7.sh
```

Type **px** and press **Return** to verify no processes are running.
3. Create a temporary directory on the SS7 A-Active side or on any other machine and FTP/copy the following from B-side (standby):
 - **EBSkeyfile.dat** file from B-side (located in **/export/home** or in **EB\$HOME/access/dat**)
 - **\$SPC/mml** files
 - **\$XNV/ckt***
 - **grp***
 - **CktInt.cfg** files
 - **SS7 \$XNV/template** files
 - **/etc/hosts** file (just to reference the hostnames and IP addresses)

4. Once you have saved the files from B-side (standby), you may continue reloading the Solaris Operating System.

NOTE: Check the Solaris documentation for specific references.

5. Make sure you have the following items ready:
 - the CD ROM drive shipped with the system
 - the power cord for the CD ROM drive
 - the SCSI cable for the CD ROM drive
 - the Solaris OS CD ROM shipped with the system
6. Put the CD ROM drive near the Sparc on a flat surface.
7. Connect the power and SCSI cables.
8. Insert the Solaris OS CD ROM into the drive.
9. Make sure you have a console attached.
10. Log in to the Integrated SS7 system as **root**.
11. Type **halt** and press **Return**.
12. At O.K. prompt, enter the following command and press **Return**:

```
boot cdrom - install
```
13. Once the system boots, it will come up as if you ran sys-config for the first time. Follow the directions in *Section 3.3* for running sys-config.

*NOTE: If your Integrated SS7 system console is a VT100 terminal, press **PF2** on the numeric keypad instead of the **F2** key.*

C.4 INSTALLING SOLARIS 2.6 PATCHES

1. If you haven't already done so, log in to the Integrated SS7 system as **ckint**.
2. Stop the SS7 stack by entering the following command and pressing **Return**:

```
stop-ss7.sh
```

Type **px** and press **Return** to verify no processes are running.
3. Create a new directory named **sol2.6patches** under **/export/home** on the SS7 system.
4. **cd** to **sol2.6patches**.
5. From % prompt, FTP to **Cisco/S4** ftp server to get the required Solaris 2.6 patches.
6. Enter the following command and press **Return**:

```
ftp 198.92.30.33
```

```
user = ftp
```

```
passwd = your full e-mail address
```
7. At the **ftp>** prompt, enter your user name and press **Return**.
8. At the **pwd** prompt, enter your full e-mail address and press **Return**.

9. The ftp server will respond with the following:

“/” is the current directory

10. Enter the following command and press **Return**:

```
cd /mhaider/sol2.6patch
```

11. Type **ls -l** and press **Return**.

12. You will find the following files under the specified directory:

```
-rw-r--r-- 1 mhaider eng 3327787 Jan 15 1999 105181-04.tar.Z
-rw-r--r-- 1 mhaider eng 2464611 Jan 15 1999 105210-06.tar.Z
-rw-r--r-- 1 mhaider eng 116549 Jan 15 1999 105216-02.tar.Z
-rw-r--r-- 1 mhaider eng 164807 Sep 29 11:56 105529-08.tar.Z
-rw-r--r-- 1 mhaider eng 186797 Jan 15 1999 105604-02.tar.Z
-rw-r--r-- 1 mhaider eng 117369 Jan 15 1999 105615-03.tar.Z
-rw-r--r-- 1 mhaider eng 108697 Jan 15 1999 105665-01.tar.Z
-rw-r--r-- 1 mhaider eng 124689 Jan 15 1999 105667-01.tar.Z
-rw-r--r-- 1 mhaider eng 216433 Jan 15 1999 105786-04.tar.Z
-rw-r--r-- 1 mhaider eng 136995 Jan 15 1999 106125-02.tar.Z
-rw-r--r-- 1 mhaider eng 1296 Jan 15 1999 patchinstall2.6
```

13. Set mode to binary by entering **bin** and pressing **Return**.

14. Type **hash** and press **Return**.

15. Type **mget *** and press **Return**.

16. To get each file type, for “yes” type **y** and press **Return**.

17. After you get all the files into directory **sol2.6patches**, type **bye** and press **Return** to quit the FTP session.

18. Change permissions on file **sol2.6patches** to **777**.

19. Switch user to **su**.

20. At the prompt, enter the following command and press **Return**:

```
./patchinstall2.6
```

This will install Solaris 2.6 patches on your system.

NOTE: If the CD ROM you re-installed from contained higher level patches, you will receive warning messages.

21. Reboot the Integrated SS7 system.
22. Log in to the Integrated SS7 system as **cktint**.

C.5 FINISHING UPGRADE/RE-INSTALLATION ON REDUNDANT SYSTEM

1. After the system comes up successfully on the B-side (SBY), put the switch in the "B-ACT/A-SBY" state by running the Switch Active Side to Standby utility from the VCO/4K System Administration Console on the active side of the system. (Refer to the *VCO/4K System Administrator's Guide* for information on the utility.)
2. Hard-select the ACT side.
3. Move the VCO/4K AAC card's "Select Switch" from the "auto" position to the "B-ACT side."
4. Move the SS7 Fallback Switch "Select Switch" from the "auto" position to the "B-ACT side."
5. Check to see if links are aligned, calls are being processed and the system is fully operational.
6. Repeat all the steps for reloading the Solaris Operating System on the A-side.

C.6 ERRORS AFTER UPGRADE/RE-INSTALLATION

After the upgrade/re-installation, you may find errors such as:

```
ld.so.1:/export/home/EBS/access/bin/AccessAlarm:fatal:libC.so.3.0:can't open
```

-or-

```
"Alarm Handler" errors
```

Should you find any errors on the SS7 startup, do the following:

1. Log in to the Integrated SS7 system as **cktint**.
2. Enter the following command and press **Return**:

```
stop-ss7.sh
```

Type **px** and press **Return** to verify no processes are running.

3. **cd** to **/usr/lib**.
4. Type **ls -l libC*** and press **Return**.
5. The following files should display:

```
libC.so.3
```

```
libCso.5
```

6. Change user as root (super user) by typing **su** followed by password.

7. At **hash** prompt, enter the following command and press **Return**:

```
ln -s libC.so.3 libC.so.3.0
```

This will create a symbolic link between the two files.

8. Exit from **root**.
9. Enter the following command and press **Return**:

```
start-ss7.sh
```

10. This should bring up the stack without any problems. You should also be able to see Access Alarms.

Appendix D

UPGRADING/RE-INSTALLING THE INTEGRATED SS7 SOFTWARE

D.1 INTRODUCTION

The software is loaded on the Integrated SS7 system hard drive at the factory. The information in this appendix is supplied in the event you need to upgrade or re-install the software.

D.2 RE-INSTALLING THE SERIAL PORT SBUS CARD SOFTWARE

Reinstall the software for the modem's serial port on the Sbus card following the procedures in the manufacturer's documentation (Magma).

D.3 PREPARING FOR UPGRADE/RE-INSTALLATION

1. If you have a redundant system, upgrade/install the Standby (SBY) side first.
2. Put the switch in the "A-ACT/B-SBY" state by running the Switch Active Side to Standby utility from the VCO/4K System Administration Console on the active side of the system. (Refer to the *VCO/4K System Administrator's Guide* for information on the utility.)
3. Hard-select the ACT side.
4. Move the VCO AAC card's "Select Switch" from the "auto" position to the "A-ACT side."
5. Move the SS7 Fallback Switch "Select Switch" from the "auto" position to the "A-ACT side."
6. Log in to the Integrated SS7 system as **cktint**.
7. On the standby side, enter the following command and press **Return**:

```
stop-ss7.sh
```

Type **px** and press **Return** to verify no processes are running.

8. Create a temporary directory on the SS7 A-Active side or on any other machine and FTP/copy the following from B-side (standby):
 - **EBSkeyfile.dat** file from B-side (located in **/export/home** or in **/export/home/EBS/access/dat**)
 - **/export/home/cktint/sys/SPcc<n>/mml** files
 - **/export/home/cktint/sys/CktintAnEnv/ckt*** files
 - **/export/home/cktint/sys/CktintAnEnv/grp*** files
 - **/export/home/cktint/sys/CktintAnEnv/CktInt.cfg** file
 - **/export/home/cktint/sys/CktintAnEnv/template/*** files
 - **/etc/hosts** file (just to reference the hostnames and IP addresses)
 - **/export/home/EBS/access/config/AccessRd.cfg** files

NOTE: Always use full path names for FTP.

D.4 UPGRADING/RE-INSTALLING THE INTEGRATED SS7 SOFTWARE

This subsection describes how to upgrade/re-install all of the Integrated SS7 software.

D.4.1 Copying Software Diskettes, Changing File Permissions, and Removing EBS Drivers

1. If you haven't already done so, log in to the Integrated SS7 system as **root**.
2. **cd** to **/export/home**.
3. Enter the following command and press **Return**:

```
/etc/init.d/volmgt stop
```

4. Copy the Integrated SS7 floppies to the system drive:
 - a. Insert the first EBS Software floppy in the Integrated SS7 system drive.
 - b. Enter the following command and press **Return**:

```
cpio -icdub -C65536 -I/dev/rfd0
```

When the system is finished copying disk 1, the following message appears:

```
End of medium on "input"  
Change to part 2 and press RETURN key. [q]
```

- c. Insert the second floppy and press **Return**.
 - d. Repeat Steps A through C for each software component (EBS software, Circuit Interworking, and PPP) until all of the floppies are copied to the system disk.

NOTE: You only have to copy the diskettes for the software component(s) you need.

5. Enter the following command and press **Return**:

```
/etc/init.d/volmgt start
```

6. When the system has copied all of the SS7 software, change the permissions on the install scripts:
 - a. Change permissions on the Circuit Interworking install script by entering the following command and pressing **Return**:

```
chmod 755 ./install_cktint.sh
```
 - b. Change permissions on the EBS install script by entering the following command and pressing **Return**:

```
chmod 755 ./install_ebs.sh
```
7. **cd** to **\$EBSHOME/access/install**
8. Type **./rmebsdrv** and press **Return**.
9. Type **y** at the prompt and press **Return**.
10. Type **reboot** and press **Return**.

D.4.2 Re-Installing Circuit Interworking.

1. Log in to the Integrated SS7 system as **root**.
2. Enter the following command and press **Return**:

```
./install_cktint.sh
```

Messages similar to the following appear:

```
#####
Installing cktint (File: cktint.cpio.Z)
#####
```

*NOTE: If the directory **/export/home/cktint** already exists, you will be asked if you would like to move it with the following message:*

```
The directory /export/home/cktint already exists.
Would you like to move /export/home/cktint [y/n]?
```

If you do not move cktint to a new name, the script will terminate.

*Type **y** and press **Return**.*

*Then, enter a directory extension name. This will move the existing **/export/home/cktint** to **/export/home/cktint.old**. Continue with the installation.*

```
Creating cktint account...
done
Extracting files...
done
Setting up...
done
```

NOTE: If `/etc/rc3.d/S85ss7` does not exist, you will be asked if you want to install the autostart option with the following message:

```
Autostart script S85ss7 does not exist.  
Would you like to install it [y/n]?
```

*Type **y** and press **Return**. The following message appears:*

```
Installing /etc/rc3.d/S85ss7...done
```

```
Adding entries to /etc/system file  
Adding tcp timers to /etc/rc2.d/S69inet file  
done
```

```
Before using the Integrated SS7, please reboot.
```

*NOTE: **Do not** reboot yet.*

*Rename this file by entering the following and pressing **Return**:*

```
mv/etc/rc3d/S85ss7/etc/rc3d/s85temp
```

-OR-

*Type **n** and press **Return**. Autostart is **not** installed.*

3. **cd** to `$EBSHOME/access/install`
4. Type `./setupebsdrv` and press **Return**.
5. Type **y** at the prompt and press **Return**.
6. The installation script for the Circuit Interworking software creates the user ID **cktint**. Use this user ID when performing Circuit Interworking software functions as described in this section and *Section 3*.
7. When the installation script is complete, the UNIX command prompt appears.

At this point, the Integrated SS7 system software is configured with the user ID **cktint**. The home directory for **cktint** is `/export/home/cktint ($HOME)`.

D.4.3 Re-installing EBS

1. Log in to the Integrated SS7 system as **root**.
2. Change permissions on the **.cshrc** script:
 - a. **cd** to **/export/home/cktint**.
 - b. Change permissions on the **.cshrc** script by entering the following command and pressing **Return**:

```
chmod 644 .cshrc
```

3. **cd** to **/export/home**.
4. At the system prompt, enter the following command and press **Return**:

```
./install_ebs.sh
```

Messages similar to the following appear:

```
#####
Installing EBS Software (File: ebs.CC34.00.sbus.cpio.Z)
```

```
#####
```

```
Extracting files from archive. This will take a little while ....
```

```
The Solaris kernel drv and strmod modules will now be rebuilt with the EBS Software.
```

```
EBS home is /export/home/EBS
```

```
Calling rmEBSdrv in /export/home/EBS/access/install
```

```
You are about to remove the AccessMANAGER modules.
```

```
Do you wish to continue[y/n]?
```

5. Type **y** and press **Return**. Messages similar to the following appear:

```
Unloading ANTC module ...
```

```
ANTC module is now unloaded.
```

```
.
```

```
.
```

```
All AccessMANAGER modules are now removed.
```

```
Calling setupEBSdrv in /export/home/EBS/access/install
```

```
You are about to install the AccessMANAGER modules.
```

```
Do you wish to continue [y/n]?
```

6. Type **y** and press **Return**. Messages similar to the following appear:

```
Installing SPM module ...  
SPM module is now installed.
```

```
.  
.
```

```
Installation of AccessMANAGER modules is now complete.
```

```
The new Solaris drv and strmod modules are now installed.
```

```
Installation complete. Reboot not required.
```

7. To configure PPP, complete the following steps:

- a. Run the **install_ppp.sh** script.
- b. Acquire two more IP addresses from your system administrator. Ensure that the addresses are on the same network as the Integrated SS7 system.
- c. Verify that your user ID is still root and open the **/etc/hosts** file in located in the system's root directory.
- d. Modify the **/etc/hosts** file to include the two new lines:

```
<ipaddress><hostname>ppp  
<ipaddress>ppp-dialinpc
```

where the two **<ipaddress>** variables are the IP Addresses you acquired from your system administrator in Step 9b and **<hostname>** is the name of the Integrated SS7 system.

NOTE: If the Integrated SS7 system is part of the greater network that is running NIS or NIS+, the /etc/hosts file of the name server's must be modified to include these changes as well.

- e. Modify the **/etc/asppp.cf** file to include the following line before the "defaults" line.

```
ifconfig ipdptp0 plumb <hostname>ppp down
```

where **<hostname>** is the name of the Integrated SS7 system.

- f. Modify the permissions on the **/etc/asppp.cf** file using the following command:

```
chmod 600 /etc/asppp.cf
```

8. Apply all modifications to the appropriate configuration files for your specific system.
9. Reboot the Integrated SS7 system.

D.4.4 Restoring Configuration

1. If you purchased the 2k-to-4k configurator and wish to run in 4K mode, re-install and run the configurator (see *Section 4.6*).
2. Log in to the Integrated SS7 system as **cktint**.
3. FTP and recover all configuration files that were preserved/saved from the B-side prior to beginning reload and place them in their correct location.
4. Once the files are placed/copied to their proper location, you can start rebuilding the database configuration.
5. **cd** to **\$EBSHOME/access/RUN0/DBfiles**.
6. Remove all files, if any, by typing **rm <filename>** and pressing **Return**.
7. Type **cd** and press **Return**.
8. Type **cd backup** and press **Return**.
9. Remove all files, if any, by typing **rm <filename>** and pressing **Return**.
10. Change permissions on the **.cshrc** script by entering the following command and pressing **Return**:

```
chmod 644 $HOME/.cshrc
```

11. Use the vi editor to open the file **\$HOME/.cshrc** and add the following line:

```
setenv CC_CONFIG tup
```

12. To have the change take affect (without logging out and logging back in again), enter the following command and press **Return**.

```
source $HOME/.cshrc
```

13. Type **cd \$SPC** and press **Return**.
14. In the mtp.mml file, change/verify your port numbers to 1, 2, 3, 4 (5, 6, 7, 8, depending on your configuration) if you are using all links/ports.

Now you have removed the old database and want to configure the new. The following steps/procedures are always performed when any changes are made to the .mml files:

1. On prompt, enter the following command and press **Return**:

```
ebs_start
```

Wait for some time and press **Return**.

2. On prompt, enter the following command and press **Return**:

```
upmd 0 &
```

Wait for some time and press **Return**.

3. On prompt, enter the following command and press **Return**:

```
snmd 0 &
```

Wait for some time and press **Return**.

4. Make sure you are in directory **\$SPC**.
5. On prompt, enter the following command and press **Return**:

```
mml 0 mtp.mml
```

You should see successes for all lines for the **mtp.mml** file.
6. On prompt, enter the following command and press **Return**:

```
AccessTUP 0 &
```
7. On prompt, enter the following command and press **Return**:

```
mml 0 tup.mml
```

You should see successes for all lines for the **tup.mml** file.
8. Enter the following command and press **Return**:

```
stop-ss7.sh
```

Type **px** and press **Return** to verify no processes are running.
9. If redundant, **cd** to **/export/home/cktint**.
10. Change permissions on the **.cshrc** script by entering the following command and pressing **Return**:

```
chmod 644 $HOME/.cshrc
```
11. Use the vi editor to open the file **\$HOME/.cshrc** and perform the following steps:
 - a. Remove the comment symbol (#) from the following line:

```
#setenv PLTFRMTYP REDUNDANT
```
 - b. Add the comment symbol (#) to the following line:

```
setenv PLTFRMTYP STANDALONE
```
 - c. Add the following line:

```
setenv EBSHOME /export/home/EBS
```
 - d. Save the changes and close the file.
12. To have the change take affect (without logging out and logging back in again), enter the following command and press **Return**.

```
source $HOME/.cshrc
```

13. Use the vi editor to open the file **\$EBSHOME/access/config/AccessRd.cfg**.

a. Check the following lines. The lines should read:

```
SERIAL_PORT          /dev/ttyb
SWITCH_TYPE          4_PORT
STATE_CHANGE_TIMER   20
PAUSE_TIMER          2
ACTION_ORDER         START_SCRIPT SEND_MSG
MONITOR_OPTION       OFF
CTS_CONFIGURATION    INVERTED
SWITCH_OVER          ENABLED
STATE_CHANGE_MAX     5
HOST-A               <A-side Integrated SS7 system name>
                    (i.e., HOST-A tsup6ss7a)
HOST-B               <B-side Integrated SS7 system name>
                    (i.e., HOST-B tsup6ss7b)
```

b. If the lines do not match, modify them accordingly.

c. Save the changes and close the file.

14. Cross-mounted files must be configured in the **/etc/vfstab** file. Use the vi editor to open the file and add the following line:

```
<B-side Integrated SS7 system name>:/export/home/access/dat
-/export/home/EBS/access/rd  nfs - yes soft,bg
```

15. The share option must be configured in the **/etc/dfs/dfstab** file. Use the vi editor to open the file and add the following line:

```
share -F nfs -o rw,root=<B-side Integrated SS7 system name>
/export/home/EBS/access/dat
```

16. To load the rd file, enter the following command and press **Return**:

```
exportfs -a
```

17. Confirm proper configuration by entering the following line and pressing **Return**:

```
exportfs
```

Messages similar to the following should appear:

```
/export/home/EBS/access/dat  rw,root=<B-side Integrated SS7 system name>  ""
```

18. To mount the rd file, enter the following commands and press **Return** after each:

```
/usr/lib/nfs/mountd
/usr/lib/nfs/nfsd -a 16
mount /export/home/EBS/access/rd
```

19. Confirm NFS is mounted properly by entering the following line and pressing **Return**:

```
df -k /export/home/EBS/access/rd
```

Messages similar to the following should appear:

```
vt-8ss7a# df -k /export/home/EBS/access/rd
Filesystem      kbytes  used  avail capacity  Mounted on
vt-8ss7b:/export/home/EBS/access/dat
                677880 540344 76528   88%  /export/home/EBS/access/rd
```

20. Set the Level 2 timer T0 to 160 msec.

- a. Enter the following command and press **Return**:

```
mml 0
MODIFY-L2TIMER:TIMER=0,VALUE=160;
```

- b. Confirm proper settings by entering the following line and pressing **Return**:

```
DISPLAY-L2TIMER:TIMER=0;
```

21. Log in as **root** to the Integrated SS7 system side B, <hostname>b, and repeat step 10 through step 20.

- a. This time, the line in step 14 should read:

```
<A-side Integrated SS7 system name>:/export/home/access/dat
- /export/home/EBS/access/rd  nfs – yes soft,bg
```

- b. The line in step 15 should read:

```
share -F nfs -o rw,root=<A-side Integrated SS7 system name>
/export/home/EBS/access/dat
```

- c. The line in step 16 should still read:

```
exportfs -a
```

- d. The message returned in step 17 should be similar to the following:

```
/export/home/EBS/access/dat  rw,root=<A-side Integrated SS7 system name>  ""
```

- e. The messages returned in step 19 should be similar to the following:

```
vt-8ss7b# df -k /export/home/EBS/access/rd
Filesystem      kbytes  used  avail capacity  Mounted on
vt-8ss7a:/export/home/EBS/access/dat
                578920 533512 44824   93%  /export/home/EBS/access/rd
```

22. Check to make sure the SS7 Integrated Software version matches that on side A. Enter the following commands and press **Return** after each:

```
%cd $XNV
%version cktint
```

23. Enter the following command and press **Return**:

```
start-ss7.sh
```

Type **px** and press **Return** to verify no processes are running.

D.5 RE-INSTALLING THE EBS SS7 LICENSE FILE

To reinstall the EBS SS7 license file, complete the following steps:

1. If you haven't already done so, log in as **root**.
2. Insert the EBS SS7 license floppy diskette into the floppy drive.
3. Change directory (**cd**) to **/export/home**.
4. Enter the following command and press **Return**:

```
/etc/init.d/volmgt stop
```

5. Enter the following command and press **Return**:

```
tar xvf /dev/rfd0
```

6. Enter the following command and press **Return**:

```
/etc/init.d/volmgt start
```

7. Verify that you have a valid license by completing the following steps:
 - a. Execute the UNIX **hostid** command and note the system's Host ID.
 - b. Use the vi editor to open the **EBSkeyfile.dat** file. This file contains a line that looks similar to the following:

```
#=====#
  L112345678  <co.name> 8765432  2  08  hkt  340  20Aug95  0days
#=====#
```

↑
↑
 License Number Host ID

The Host ID listed in this file should match the system's Host ID.

- c. Exit the vi Editor. If the Host IDs do not match, the license is invalid and the EBS SS7 software will not run. Contact Cisco Systems Technical Support.

Re-installing The EBS SS7 License File

Appendix E

TUP MESSAGE TYPES AND PARAMETERS

E.1 TUP MESSAGE TYPES

Table E.1: TUP Message Types Listed By Binary Code

Hex Code	Binary Code	Message Type	Acronym
06	0000 0110	Answer, Unqualified	ANU
11	0001 0001	Initial Address Message	IAM
12	0001 0010	General Forward Set-up Information	GSM
13	0001 0011	General Request	GRQ
14	0001 0100	Address Complete Message	ACM
15	0001 0101	Switching Equipment Congestion	SEC
16	0001 0110	Answer, Charge	ANC
17	0001 0111	Release Guard	RLG
18	0001 1000	Maintenance Oriented Group Blocking	MGB
21	0010 0001	Initial Address with Additional Information	IAI
24	0010 0100	Charging	CHG
25	0010 0101	Circuit Group Congestion	CGC
26	0010 0110	Answer, No Charge	ANN
27	0010 0111	Blocking	BLO
28	0010 1000	Maintenance Oriented Group Blocking Acknowledgment	MBA
31	0011 0001	Subsequent Address	SAM
32	0011 0010	Continuity	COT
35	0011 0101	National Network Congestion	NNC
36	0011 0110	Clear Back	CBK
37	0011 0111	Blocking Acknowledgment	BLA
38	0011 1000	Maintenance Oriented Group Unblocking	MGU
41	0100 0001	Subsequent Address Message with One Signal	SAO

Table E.1: TUP Message Types Listed By Binary Code (Continued)

Hex Code	Binary Code	Message Type	Acronym
42	0100 0010	Continuity Failure	CCF
45	0100 0101	Address Incomplete	ADI
46	0100 0110	Clear Forward	CLF
48	0100 1000	Maintenance Oriented Group Unblocking Acknowledgment	MUA
55	0101 0101	Call Failure	CFL
56	0101 0110	Reanswer	RAN
57	0101 0111	Unblocking Acknowledgment	UBA
58	0101 1000	Hardware Failure Oriented Group Blocking	HGB
65	0110 0101	Subscriber Busy (Electrical)	SSB
66	0110 0110	Forward Transfer	FOT
67	0110 0111	Continuity Check Request	CCR
68	0110 1000	Hardware Failure Oriented Group Blocking Acknowledgment	HBA
75	0111 0101	Unallocated Number	UNN
76	0111 0110	Calling Party Clear	CCL
77	0111 0111	Reset Circuit	RSC
78	0111 1000	Hardware Failure Oriented Group Unblocking	HGU
85	1000 0101	Line Out-of-Service	LOS
88	1000 1000	Hardware Failure Oriented Group Unblocking Acknowledgment	HUA
95	1001 0101	Send Special Information Tone	SST
98	1001 1000	Circuit Group Reset	GRS
1A	0001 1010	Automatic Congestion Control Information	ACC
1D	0001 1101	Operator	OPR
1E	0001 1110	Subscriber Local Busy	SLB
2C	0010 1100	Metering Pulse	MPM
2E	0010 1110	Subscriber Toll Busy	STB
A5	1010 0101	Access Barred	ACB
A8	1010 1000	Circuit Group Reset Acknowledgment	GRA

Table E.1: TUP Message Types Listed By Binary Code (Continued)

Hex Code	Binary Code	Message Type	Acronym
B5	1011 0101	Digital Path Not Provided	DPN
B8	1011 1000	Software Generated Group Blocking	SGB
C8	1100 1000	Software Generated Group Blocking Acknowledgment	SBA
D8	1101 1000	Software Generated Group Unblocking	SGU
E8	1110 1000	Software Generated Group Unblocking Acknowledgment	SUA
F5	1111 0101	Extended Unsuccessful Backward Set-up Information	EUM

Table E.2: TUP Message Types Listed By Name

Message Type	Acronym	Hex Code	Binary Code
Access Barred	ACB	A5	1010 0101
Address Complete Message	ACM	14	0001 0100
Address Incomplete	ADI	45	0100 0101
Answer, Charge	ANC	16	0001 0110
Answer, No Charge	ANN	26	0010 0110
Answer, Unqualified	ANU	06	0000 0110
Automatic Congestion Control Information	ACC	1A	0001 1010
Blocking	BLO	27	0010 0111
Blocking Acknowledgment	BLA	37	0011 0111
Call Failure	CFL	55	0101 0101
Calling Party Clear	CCL	76	0111 0110
Charging	CHG	24	0010 0100
Circuit Group Congestion	CGC	25	0010 0101
Circuit Group Reset	GRS	98	1001 1000
Circuit Group Reset Acknowledgment	GRA	A8	1010 1000
Clear Back	CBK	36	0011 0110
Clear Forward	CLF	46	0100 0110

Table E.2: TUP Message Types Listed By Name (Continued)

Message Type	Acronym	Hex Code	Binary Code
Continuity	COT	32	0011 0010
Continuity Check Request	CCR	67	0110 0111
Continuity Failure	CCF	42	0100 0010
Digital Path Not Provided	DPN	B5	1011 0101
Extended Unsuccessful Backward Set-up Information	EUM	F5	1111 0101
Forward Transfer	FOT	66	0110 0110
General Forward Set-up Information	GSM	12	0001 0010
General Request	GRQ	13	0001 0011
Hardware Failure Oriented Group Blocking	HGB	58	0101 1000
Hardware Failure Oriented Group Blocking Acknowledgment	HBA	68	0110 1000
Hardware Failure Oriented Group Unblocking	HGU	78	0111 1000
Hardware Failure Oriented Group Unblocking Acknowledgment	HUA	88	1000 1000
Initial Address Message	IAM	11	0001 0001
Initial Address with Additional Information	IAI	21	0010 0001
Line Out-of-Service	LOS	85	1000 0101
Maintenance Oriented Group Blocking	MGB	18	0001 1000
Maintenance Oriented Group Blocking Acknowledgment	MBA	28	0010 1000
Maintenance Oriented Group Unblocking	MGU	38	0011 1000
Maintenance Oriented Group Unblocking Acknowledgment	MUA	48	0100 1000
Metering Pulse	MPM	2C	0010 1100
National Network Congestion	NNC	35	0011 0101
Operator	OPR	1D	0001 1101
Reanswer	RAN	56	0101 0110
Release Guard	RLG	17	0001 0111
Reset Circuit	RSC	77	0111 0111

Table E.2: TUP Message Types Listed By Name (Continued)

Message Type	Acronym	Hex Code	Binary Code
Send Special Information Tone	SST	95	1001 0101
Software Generated Group Blocking	SGB	B8	1011 1000
Software Generated Group Blocking Acknowledgment	SBA	C8	1100 1000
Software Generated Group Unblocking	SGU	D8	1101 1000
Software Generated Group Unblocking Acknowledgment	SUA	E8	1110 1000
Subscriber Busy (Electrical)	SSB	65	0110 0101
Subscriber Local Busy	SLB	1E	0001 1110
Subscriber Toll Busy	STB	2E	0010 1110
Subsequent Address	SAM	31	0011 0001
Subsequent Address Message with One Signal	SAO	41	0100 0001
Switching Equipment Congestion	SEC	15	0001 0101
Unallocated Number	UNN	75	0111 0101
Unblocking Acknowledgment	UBA	57	0101 0111

E.2 TUP MESSAGE PARAMETERS

Table E.3: TUP Message Parameters Listed By Binary Code

Hex Code	Binary Code	Parameter Name
01	0000 0001	Message Indicator
02	0000 0010	Address Signals
03	0000 0011	Closed User Group Information
04	0000 0100	Additional Calling Party Information
05	0000 0101	Additional Routing Information
06	0000 0110	Calling Line Identity
07	0000 0111	Original Called Address
08	0000 1000	Charging Information in IAI Message
09	0000 1001	Signalling Point Code
0A	0000 1010	Range and Status
0B	0000 1011	Incoming Trunk and Transit Exchange ID
0C	0000 1100	User Defined Parameter
0D	0000 1101	Undefined Parameter
0E	0000 1110	Calling Party Category
0F	0000 1111	First Indicator Octet
10	0001 0000	National Use
11	0001 0001	Address Signal in SAO
12	0001 0010	Charging Information in CHG
13	0001 0011	Request Type Indicator in GRQ
14	0001 0100	Octet Indicator in EUM
15	0001 0101	Response Type Indicator in GSM
16	0001 0110	Charging Info for CHINA
17	0001 0111	Second Indicator Octet (HONGKONG)
18	0001 1000	Service Element Indicator Octet (HKT)
19	0001 1001	SAC Information (HONGKONG)
1A	0001 1010	AFL Index (HONGKONG)
1B	0001 1011	Additional Number Indicator (HONGKONG)

Table E.4: TUP Message Parameters Listed By Name

Parameter Name	Hex Code	Binary Code
Additional Calling Party Information	04	0000 0100
Additional Number Indicator (HONGKONG)	1B	0001 1011
Additional Routing Information	05	0000 0101
Address Signal in SAO	11	0001 0001
Address Signals	02	0000 0010
AFL Index (HONGKONG)	1A	0001 1010
Calling Line Identity	06	0000 0110
Calling Party Category	0E	0000 1110
Charging Info for CHINA	16	0001 0110
Charging Information in CHG	12	0001 0010
Charging Information in IAI Message	08	0000 1000
Closed User Group Information	03	0000 0011
First Indicator Octet	0F	0000 1111
Incoming Trunk and Transit Exchange ID	0B	0000 1011
Message Indicator	01	0000 0001
National Use	10	0001 0000
Octet Indicator in EUM	14	0001 0100
Original Called Address	07	0000 0111
Range and Status	0A	0000 1010
Request Type Indicator in GRQ	13	0001 0011
Response Type Indicator in GSM	15	0001 0101
SAC Information (HONGKONG)	19	0001 1001
Second Indicator Octet (HONGKONG)	17	0001 0111
Service Element Indicator Octet (HKT)	18	0001 1000
Signalling Point Code	09	0000 1001
Undefined Parameter	0D	0000 1101
User Defined Parameter	0C	0000 1100

TUP MESSAGE PARAMETERS